



SHOWER ENCLOSURE FITTINGS

Ozone offers an extensive collection of Glass Door Hardware to create different door configurations using combination of various fittings & accessories. A wide range of patch fittings is presented here from this collection. Available in different finishes and designs, these patch fittings meet the functional as well as aesthetic need of a space. Every hardware fitting undergoes stringent tests for quality, stability, & safety as per international standards in testing parameters.

CONCEPT ELIZABETH-11

Swing Shower Enclosure 180°



Black Matt



Polished Stainless Steel



PVD Gold Glossy



PVD Rose Gold Glossy



OSKH-ACC-19 Reinforcing Rod



OPS-M1 Magnetic Seal 180°



OGH-TB 1 STD Towel Bar with Handle



OSH-2 - 180° Hinge



OPS-7 Water Dispersal Seal

osh - 2 shud not be there - ps check



OSKH-2 Track-to-Glass Connector



OSKH-1 Wall-to-Track Connector



OGC-4 L-Connector



OGC-1 Shower Screen Brackets for Floor Mounting

TYPICAL LAYOUT

Swing Shower Enclosure 180°

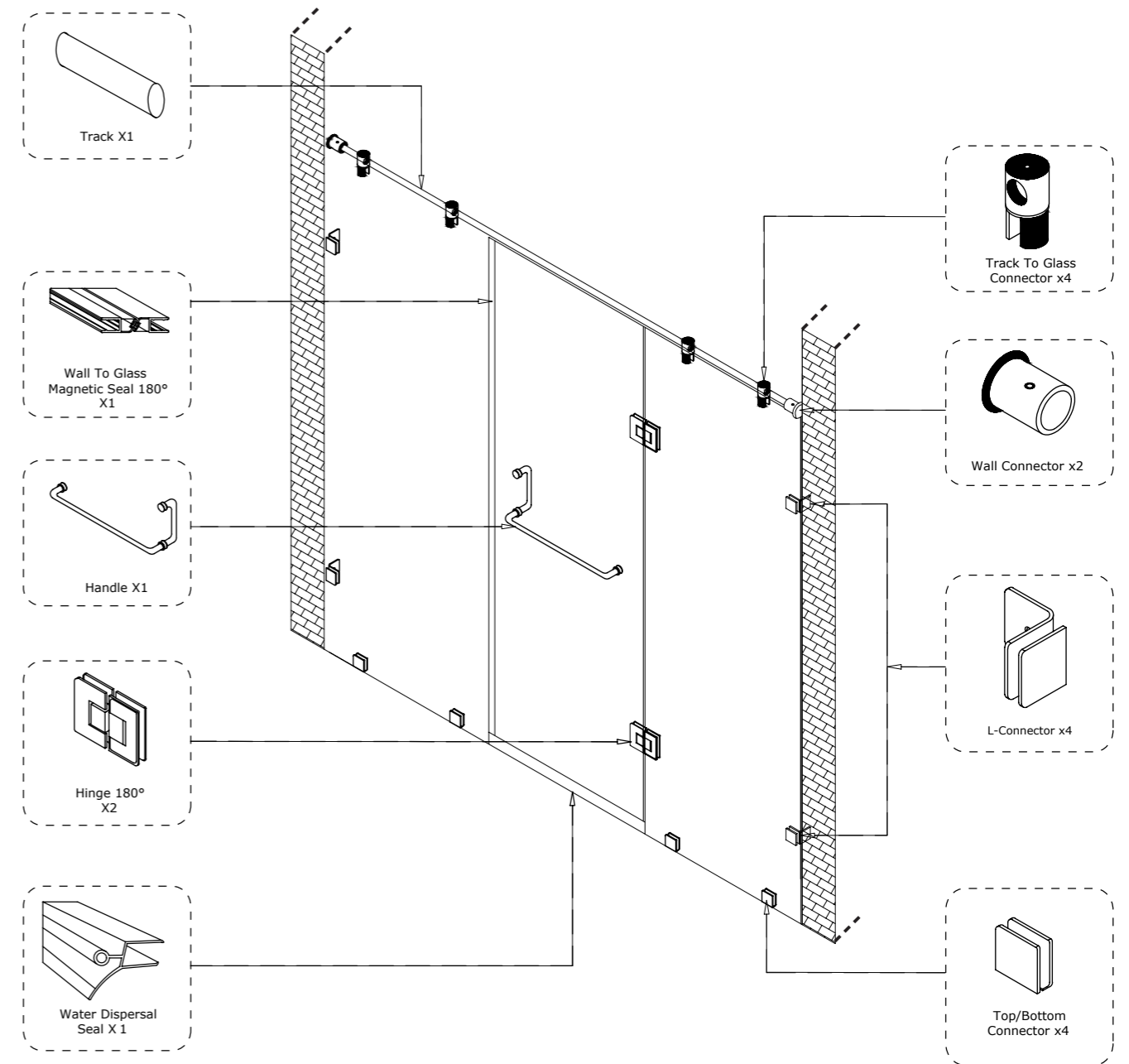

TECHNICAL DATA

Glass Type	Tempered Glass
Glass Thickness	8, 10mm
Max. Door Height	2100mm
Max. Door Weight	35-40kg
Applications	Swing Shower
Standard Finishes	PSS/ PVD Rose gold Glossy/ PVD Gold Glossy / BM
Material	Brass & SS 304

S.No.	Description	QTY.
01	Track	1
02	Wall to Glass Magnetic seal 180°	1
03	Handle	1
04	Hinge 180°	2
05	Water Dispersal	1
06	Track to Glass	4
07	Wall Connector	2
08	L-Connector	4
09	Top/Bottom Connector	4

CONCEPT ELIZABETH-22

Swing Shower Enclosure 180°



Black Matt



Polished Stainless Steel

PVD Gold Glossy

PVD Rose Gold Glossy



OSSH-ACC-25-T-ED
Connector Track Available
in 1.65mt & 2mt length



OPS-M1
Magnetic Seal 180°



OGH-TB-ED-SS
Shower Door Handle
with Towel Bar



OSSH-22-ED
Glass-to-Glass Hinge
180°



OPS-7
Water Dispersal Seal



OSSH-2-ED
Reinforcing Track
Connector with Glass



OSSH-1-ED
Reinforcing Track Con-
nector with Wall



OGC-444-ED
Wall-to-Glass
Connector 90°



OGC-111-ED
Wall-to-Glass
Connector

TYPICAL LAYOUT

Swing Shower Enclosure 180°

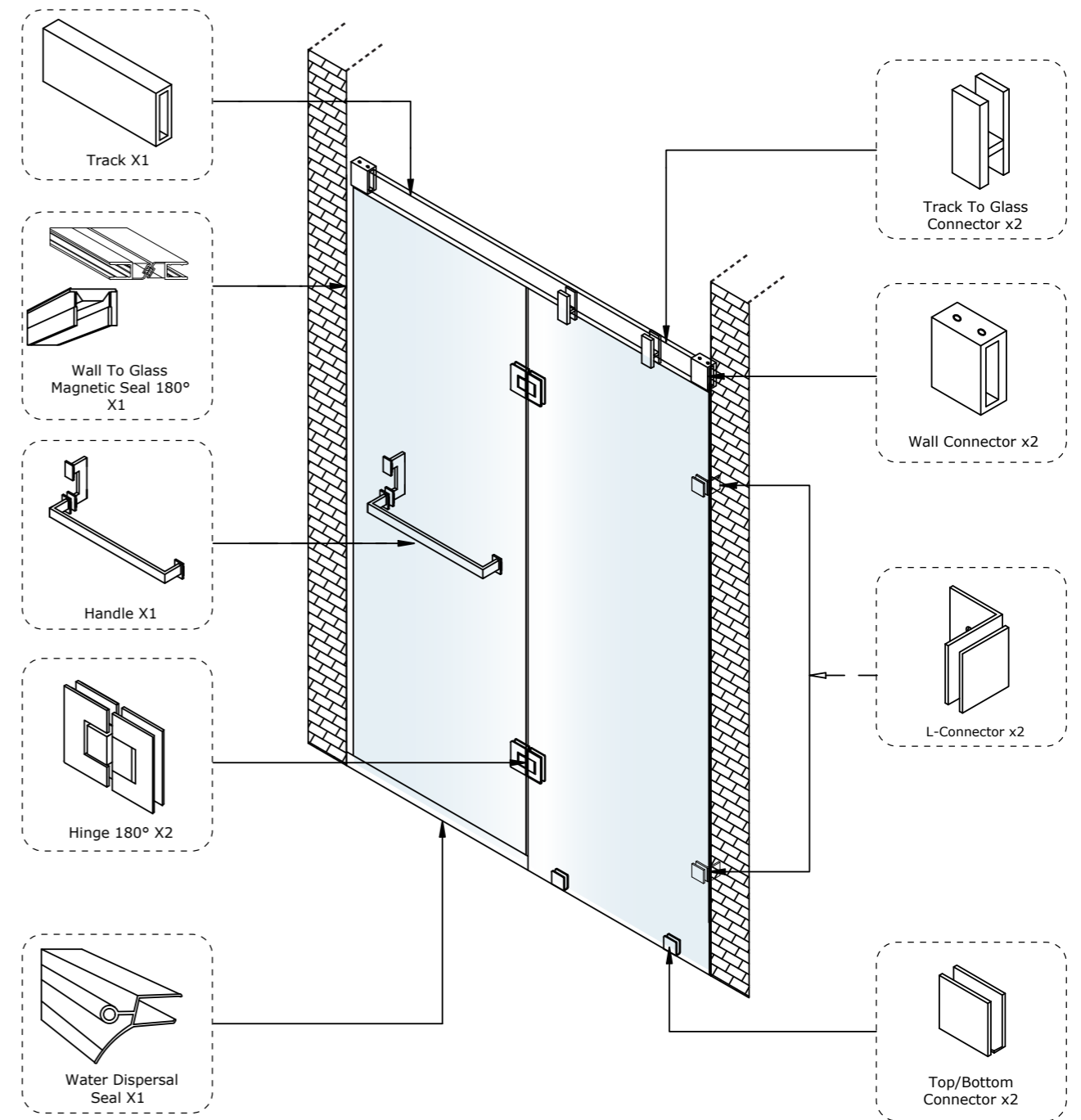

TECHNICAL DATA

Glass Type	Tempered Glass
Glass Thickness	8, 10mm
Max. Door Height	2100mm
Max. Door Weight	35-40kg
Applications	Swing Shower
Standard Finishes	PSS/ PVD Rose gold Glossy/ PVD Gold Glossy / BM
Material	Brass & SS 304

S.No.	Description	QTY.
01	Track	1
02	Wall to Glass Magnetic seal 180°	1
03	Handle	1
04	Hinge 180°	2
05	Water Dispersal	1
06	Track to Glass	2
07	Wall Connector	2
08	L-Connector	2
09	Top/Bottom Connector	2

CONCEPT ELIZABETH-22

S-Series Swing Shower Enclosure 90°



Black Matt



Polished Stainless Steel



PVD Gold Glossy



PVD Rose Gold Glossy



OSKH-ACC-19 Reinforcing Rod



OSKH-3C Pipe Connectors at any angle for Glass Stabilization



OSH-2S Glass to Glass Hinge 180°



OGH-TB-1S STD PSS Flattened Towel Bar with Knob Finish: PSS



OPS-7 Water Dispersal Seal



OSKH-1C Wall Connector



OSH-5S STD CP Wall-to-Glass Connector (Also available in rose gold)



OGC-1 Shower Screen Brackets for Floor Mounting



OPS-M3 90° magnetic seal

TYPICAL LAYOUT

S-Series Swing Shower Enclosure 90°

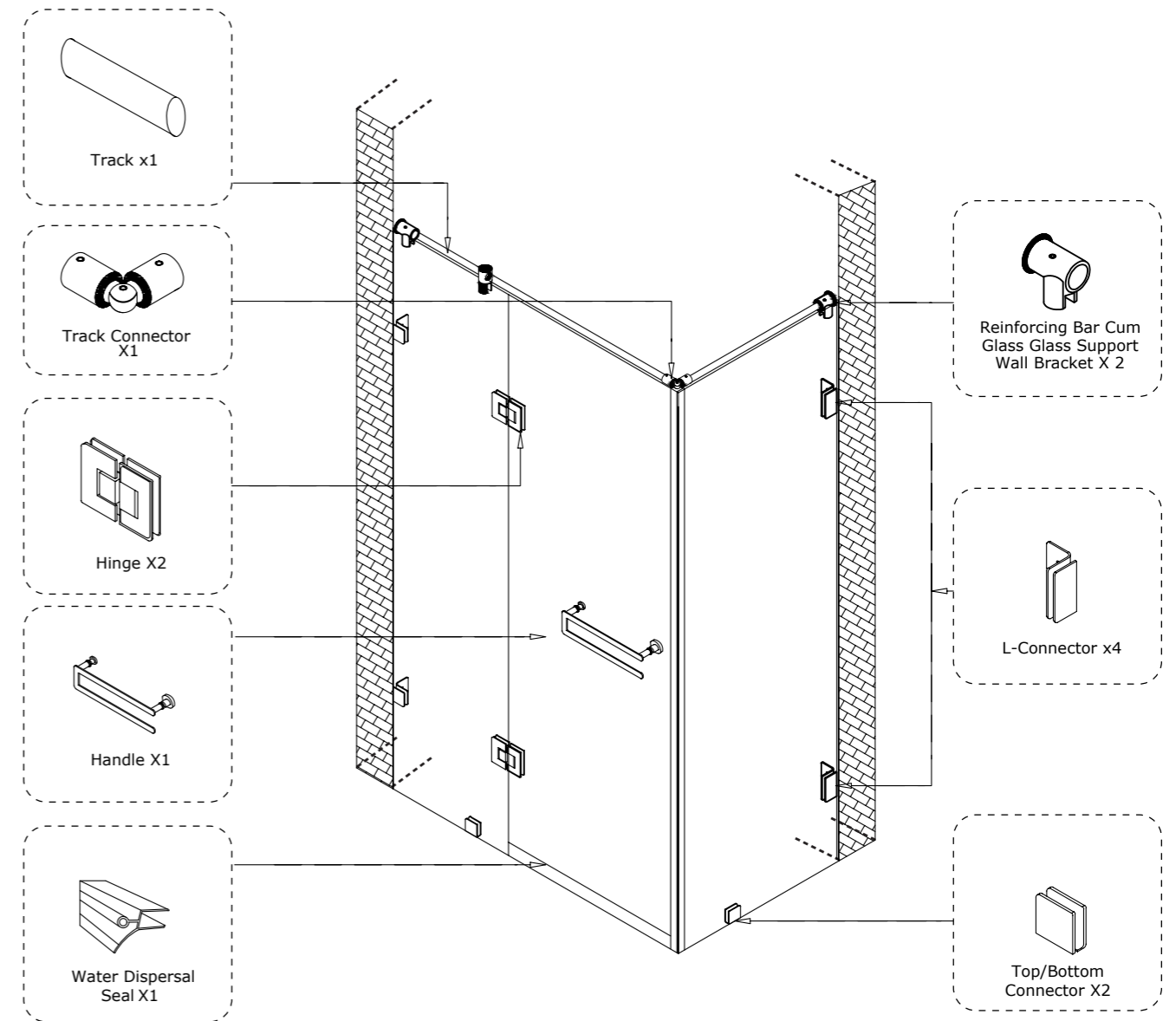

TECHNICAL DATA

Glass Type	Tempered Glass
Glass Thickness	8, 10mm
Max. Door Height	2100mm
Max. Door Weight	35-40kg
Applications	Swing Shower
Standard Finishes	PSS/ PVD Rose gold Glossy/ PVD Gold Glossy / BM
Material	Brass & SS 304

S.No.	Description	QTY.
01	Track	1
02	Track Connector	1
03	Hinge	2
04	Handle	1
05	Water Dispersal	1
06	Reinforcing Bar cum Glass Wall Bracket	2
07	L-Connector	4
08	Top/Bottom Connector	2

this is brass hinge and ss connectors -

CONCEPT ELIZABETH-44

Swing Shower Enclosure 135°



Black Matt

Watch Functional Video



Satin Stainless Steel

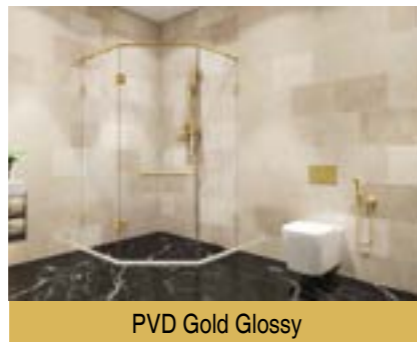

PVD Gold Glossy

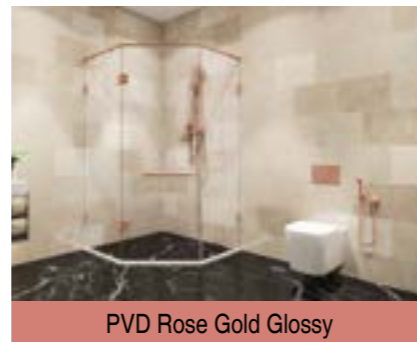

PVD Rose Gold Glossy



OSKH-ACC-19 Reinforcing Rod



OSKH-3C Pipe Connectors at any angle for Glass Stabilization



OSH-3 135° Hinge



OGH-TB 1 STD SSS Towel Bar with Handle



OPS-7 Water Dispersal Seal



OSKH-2 Track-to-Glass Connector



OSKH-1 Wall-to-Track Connector



OGC-4 L-Connector



OGC-1 Shower Screen Brackets for Floor Mounting



OSSH-55-ED Wall to Glass Bracket (Fixed Glass)

TYPICAL LAYOUT

Swing Shower Enclosure 135°

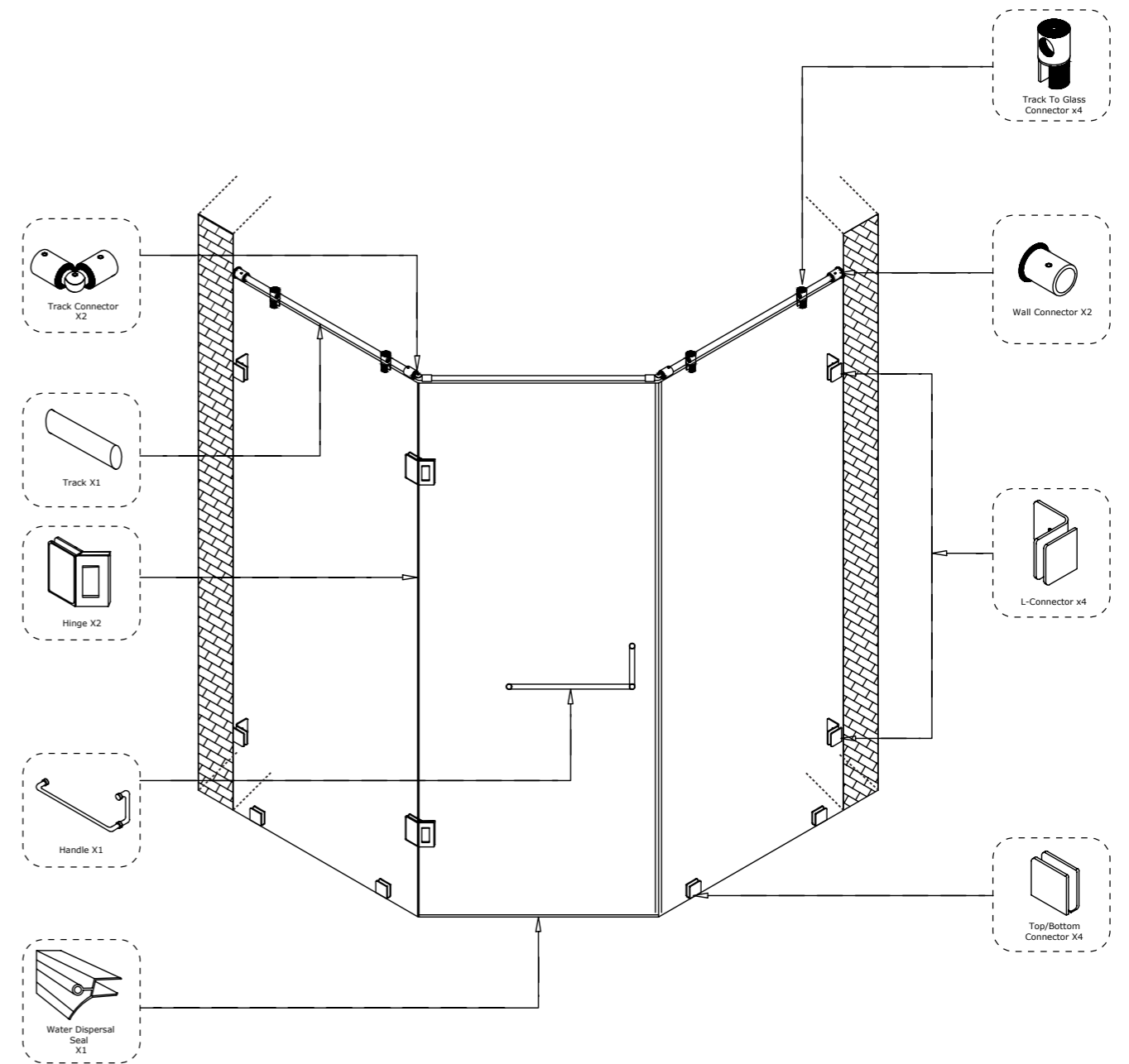

TECHNICAL DATA

Glass Type	Tempered Glass
Glass Thickness	8, 10mm
Max. Door Height	2100mm
Max. Door Weight	40-45kg
Applications	Sliding Shower Cubicle
Standard Finishes	PSS/ PVD Rose gold Glossy/ PVD Gold Glossy / BM
Material	Stainless Steel

S.No.	Description	QTY.
01	Track Connector	2
02	Track	1
03	Hinge	2
04	Handle	1
05	Water Dispersal	1
06	Track to Glass Connector	4
07	Wall Connector	2
08	L-Connector	4
09	Top/Bottom Connector	4

CONCEPT ELIZABETH-55

T - Swing Shower Enclosure



Black Matt

Watch Functional Video



Satin Stainless Steel



PVD Gold Glossy



PVD Rose Gold Glossy



OSKH-ACC-19 Reinforcing Rod



OSKH-T STD PSS Reinforcing Bars for Adjusting Shower Cubicles



OSKH-2 Track-to-Glass Connector



OSKH-1 Wall-to-Track Connector



OPS-7 Water Dispersal Seal



OGH-TB 1 STD SSS Towel Bar with Handle



OSSH-22T-ED Double Action 3-Way 'T' Shower Hinges



OGC-4 L-Connector



OGC-1 Shower Screen Brackets for Floor Mounting

TYPICAL LAYOUT

T - Swing Shower Enclosure

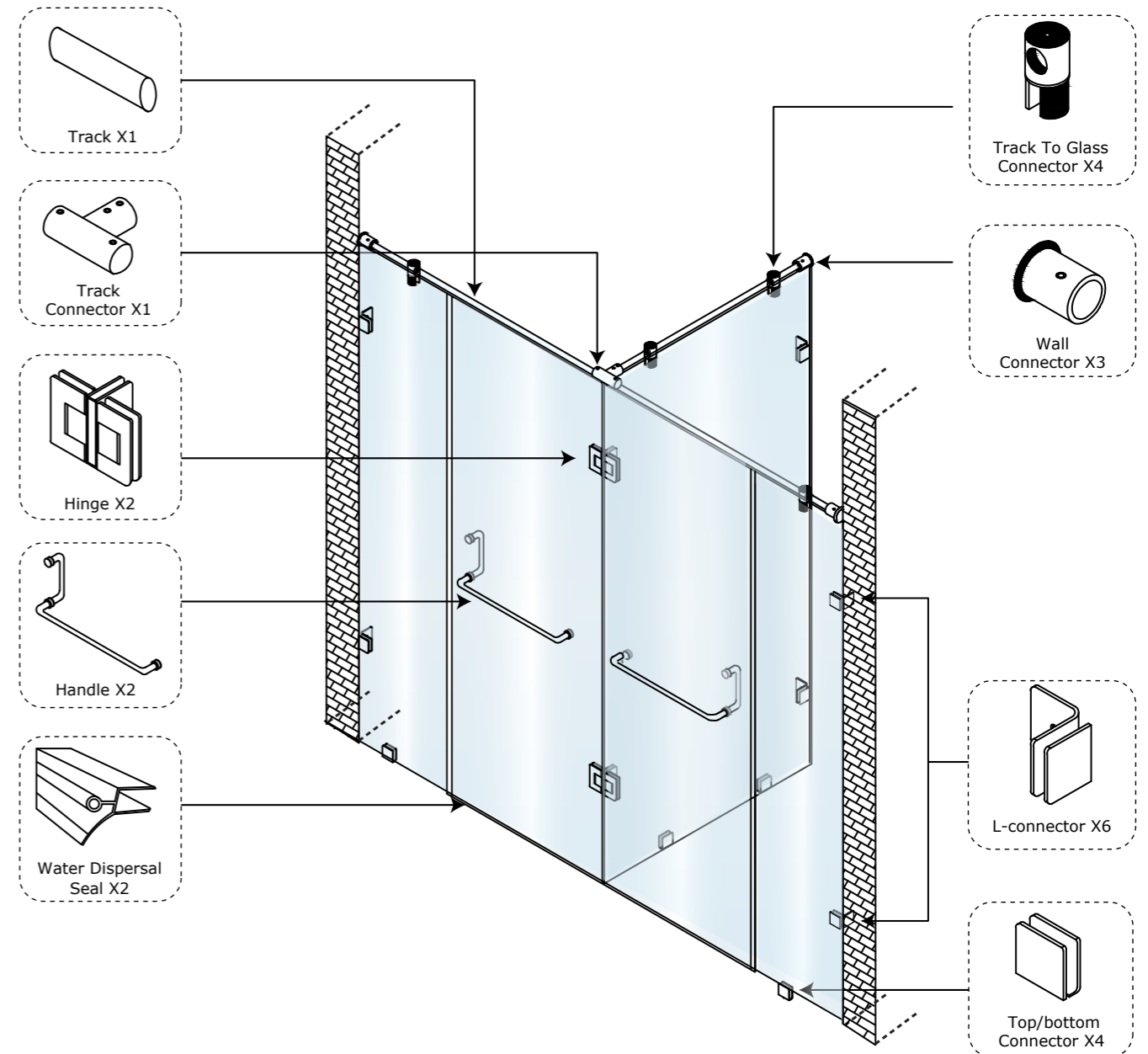

TECHNICAL DATA

Glass Type	Tempered Glass
Glass Thickness	8, 10mm
Max. Door Height	2100mm
Max. Door Weight	35-40kg
Applications	Swing Shower
Standard Finishes	PSS/ PVD Rose Gold Glossy/ PVD Gold Glossy / BM
Material	Brass & SS 3004

S.No.	Description	QTY.
01	Track	1
02	Track Connector	1
03	Hinge	2
04	Handle	2
05	Water Dispersal	2
06	Track to Glass Connector	4
07	Wall Connector	3
08	L-Connector	6
09	Top/Bottom Connector	4

'T' SWING SHOWER ENCLOSURE



OSSH-22T-ED BM
give this full page

OSSH-22T-ED PSS

Double Action 3-Way 'T' Shower Hinges

Specifications

- Maximum Glass Thickness: 8 & 10mm
- Maximum door width: 700mm
- Opening: inward (recommended) and outward
- Self-closing function activates once door reaches 300
- Available with SS 304 grade material

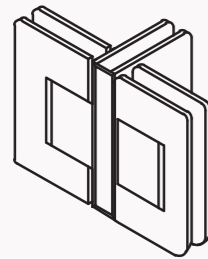

Line Drawing

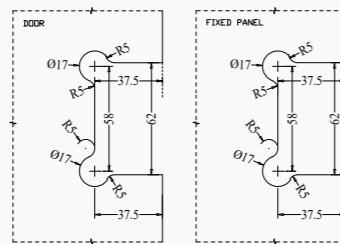

Glass Cutout

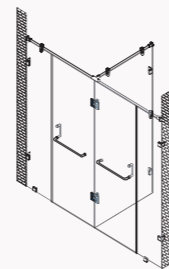

Application Drawing

SHOWER HINGES FOR 6/8MM GLASS



OSSH-1-ED 6/8mm PSS

Wall-to-Glass Hinge

Specifications

- Suitable for 6/8mm glass
- Ideal for residential showers & retail displays
- PSS finish
- Available with SS 304 grade material

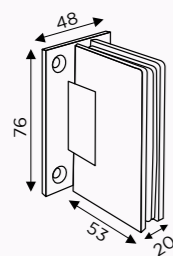

Line Drawing

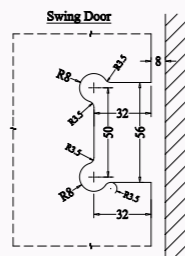

Glass Cutout

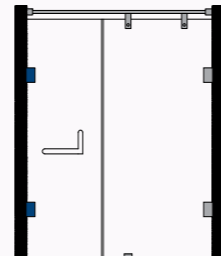

Application Drawing

SHOWER HINGES FOR 6/8MM GLASS



OSSH-2-ED 6/8mm PSS

Glass-to-Glass Hinge 180°

Specifications

- Suitable for 6/8mm glass
- Ideal for residential showers & retail displays
- PSS finish
- Available with SS 304 grade material

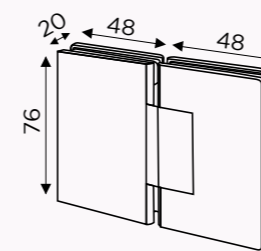

Line Drawing

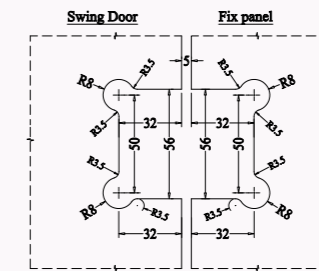

Glass Cutout

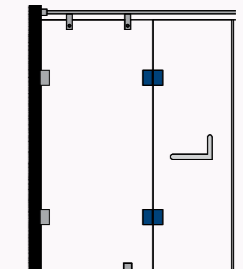

Application Drawing



OSSH-3-ED 6/8mm PSS

Glass-to-Glass Hinge 135°

Specifications

- Suitable for 6/8mm glass
- Ideal for residential showers & retail displays
- PSS finish
- Available with SS 304 grade material

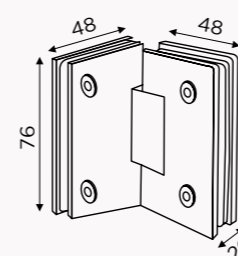

Line Drawing

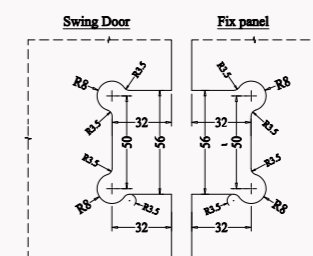

Glass Cutout

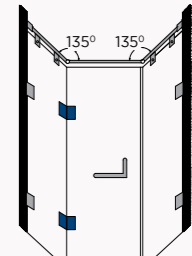

Application Drawing

SHOWER HINGES FOR 6/8MM GLASS



OSSH-4-ED 6/8mm PSS

Glass-to-Glass Hinge 90°

Specifications

- Suitable for 6/8mm glass
- Ideal for residential showers & retail displays
- PSS finish
- Available with SS 304 grade material

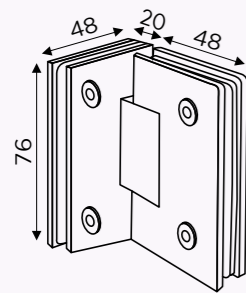

Line Drawing

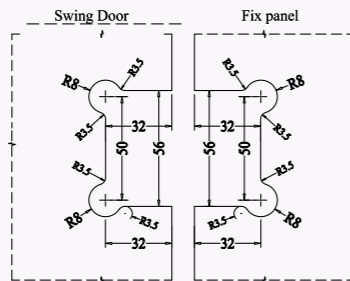

Glass Cutout

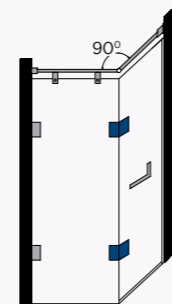

Application Drawing

SHOWER HINGES



OSH-1 STD CP OSH-1 STD SN

Wall-to-Glass Hinge for 8-10mm Glass

Specifications

- Centrally positioned pivot line
- Can be used for double action doors also
- Secure holding with glass
- With gaskets to prevent glass damage

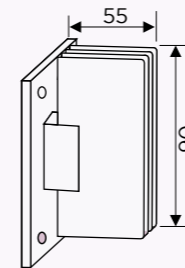

Line Drawing

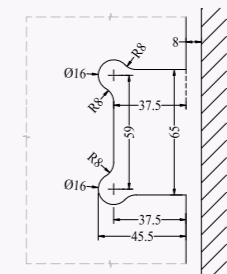

Glass Cutout

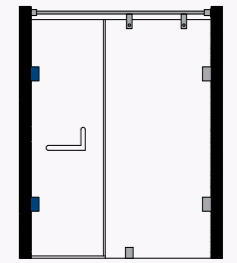

Application Drawing



OSSH-5-ED 6/8mm PSS

Wall-to-Glass Bracket (Fixed Glass)

Specifications

- Suitable for 6/8mm glass
- Ideal for residential showers & retail displays
- PSS finish
- Available with SS 304/316 Covers

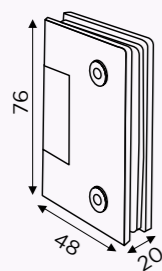

Line Drawing

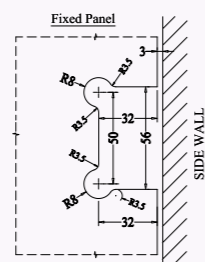

Glass Cutout

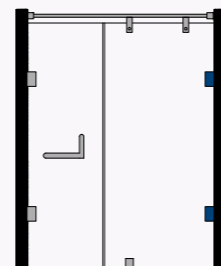

Application Drawing



OSH-2 STD CP OSH-2 STD SN

Glass-to-Glass Hinge 180° for 8-10mm Glass

Specifications

- Centrally positioned pivot line
- Can be used for double action doors also
- Secure holding with glass
- With gaskets to prevent glass damage
- High rigidity
- Finish: CP/SN

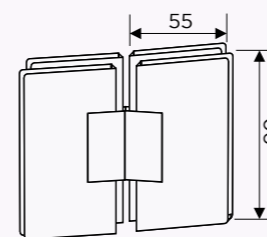

Line Drawing

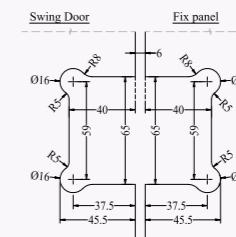

Glass Cutout

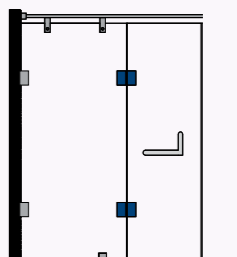

Application Drawing

SHOWER HINGES



OSH-3 STD CP OSH-3 STD SN

Glass-to-Glass Hinge 135° for 8-10mm Glass

Specifications

- Centrally positioned pivot line
- Secure holding with glass
- With gaskets to prevent glass damage
- High rigidity

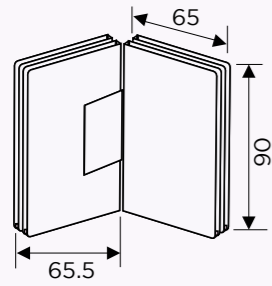

Line Drawing

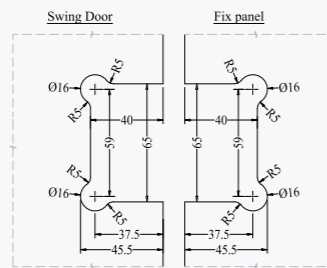

Glass Cutout

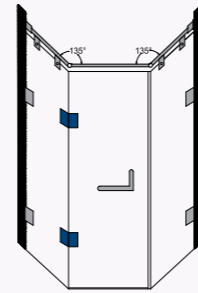

Application Drawing

SHOWER HINGES



OSH-5 STD CP OSH-5 STD SN

Wall-to-Glass Bracket for 8-10mm Glass

Specifications

- Secure holding with glass
- With gaskets to prevent glass damage
- High rigidity

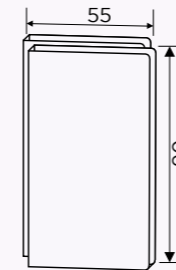

Line Drawing

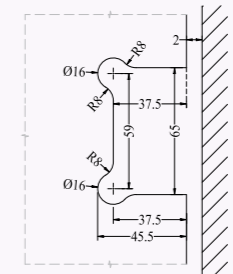

Glass Cutout

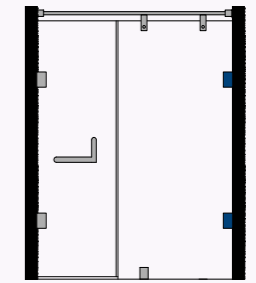

Application Drawing



OSH-4 STD CP OSH-4 STD SN

Glass-to-Glass Hinge 90° for 8-10mm Glass

Specifications

- Secure holding with glass
- With gaskets to prevent glass damage
- High rigidity

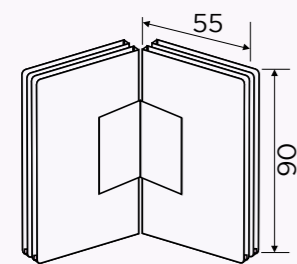

Line Drawing

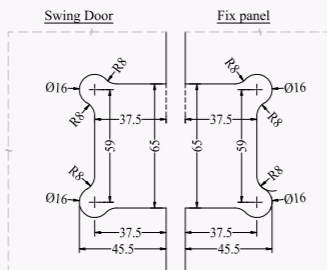

Glass Cutout

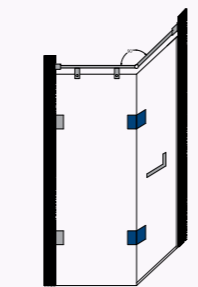

Application Drawing



OSH-OFS-1 STD CP OSH-OFS-1 STD SN

Wall-to-Glass Offset Hinge for 8-10mm Glass

Specifications

- Offset Positioned Pivot Line
- Can be used for double action doors also
- Secure holding with glass
- With gaskets to prevent glass damage

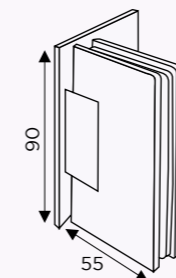

Line Drawing

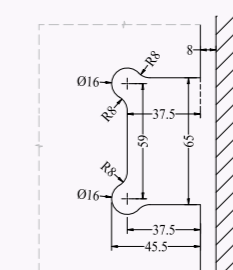

Glass Cutout

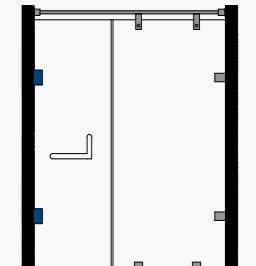

Application Drawing

SHOWER HINGES



OSH-66 CP OSH-66 SN

Wall-to-Glass Hinge for 6-8mm Glass

Specifications

- Offset pivot line
- No spring action
- Smooth opening action
- Suitable for cabinet doors
- Available with SS 304/316 Covers

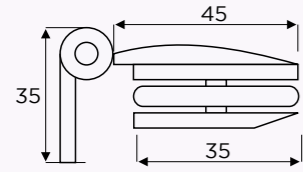

Line Drawing

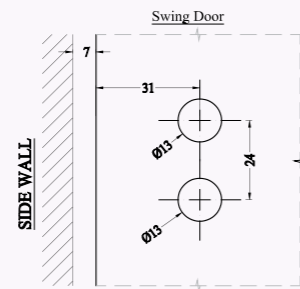

Glass Cutout

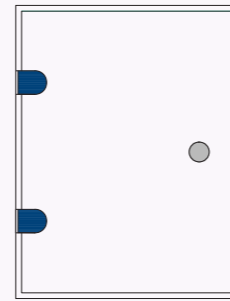

Application Drawing

SHOWER HINGES



OGC-22 Standard SSS

Shower Screen Brackets Glass-to-Glass 135°

Specifications

- Strengthening glass structure
- With gaskets to prevent glass damage
- Finish: PSS / SSS

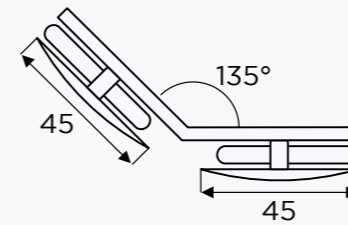

Line Drawing

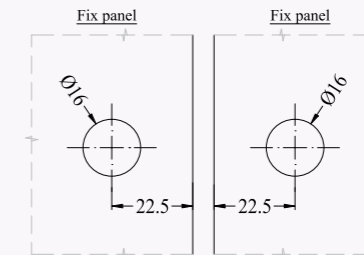

Glass Cutout

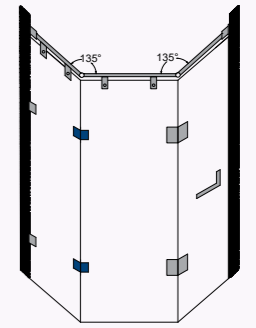

Application Drawing



OSH-77 CP OSH-77 SN

Glass-to-Glass Hinge for 6-8mm Glass (Single Side Opening)

Specifications

- Offset pivot line
- Secure holding with glass
- High rigidity
- Suitable for cabinet doors
- Single side opening
- Material: Brass

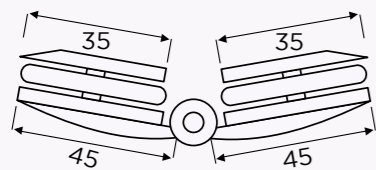

Line Drawing

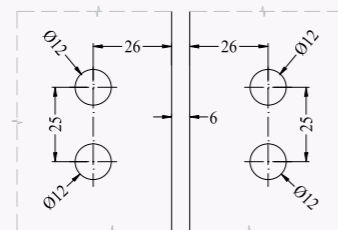

Glass Cutout

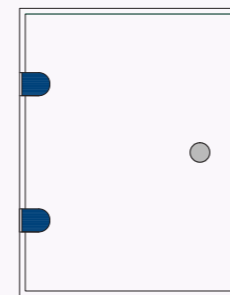

Application Drawing



OSH-6 N.A. CP

Shower Hinge Glass-to-Glass

Specifications

- Smooth movement of door
- Curved shape for aesthetics
- With gaskets to prevent glass damage
- High rigidity
- Available with SS 304 grade

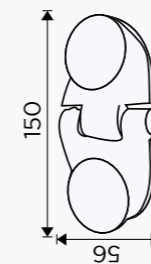

Line Drawing



Glass Cutout

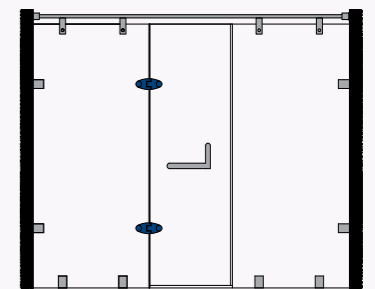

Application Drawing

SHOWER HINGES



OSH-55 STD CP OSH-55 STD SN

Wall-to-Glass Bracket (for Fixed Glass)

Specifications

- Secure holding with glass
- High rigidity
- With gaskets to prevent glass damage
- Available with SS 304 grade

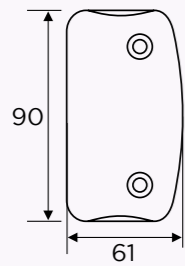

Line Drawing

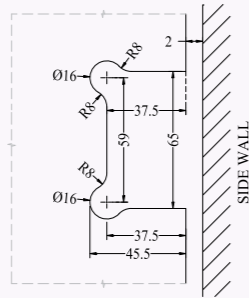

Glass Cutout

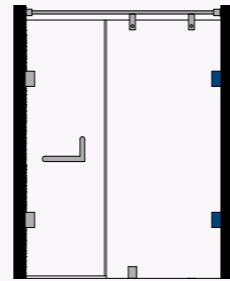

Application Drawing

SHOWER HINGES



OSH-7 STD CP

Ceiling/Floor to Glass Pivot Hinge

Specifications

- Centrally positioned pivot line
- Can be used for Double Action Doors
- Secure holding with glass
- With gaskets to prevent glass damage

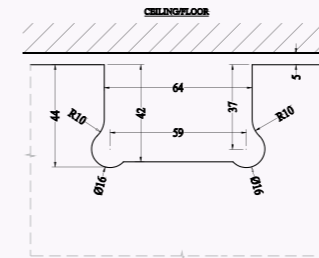

Line Drawing

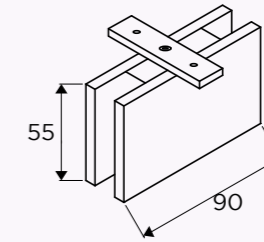

Glass Cutout

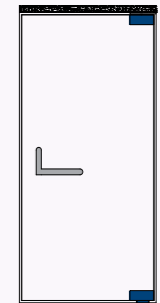

Application Drawing



OSH-44 STD CP

For Connecting a Glass Door with a Fixed Glass at 90°

Specifications

- Centrally positioned pivot line.
- Secure holding with glass.
- With gaskets to prevent glass damage.
- Door width should not exceed 800 mm.
- Door weight should not exceed 40 Kg.
- Suitable Glass thickness 8mm / 10mm.
- Available with SS 304 grade
- Fittings are to be tightened to the specified torque in all occasions (4 Nm)

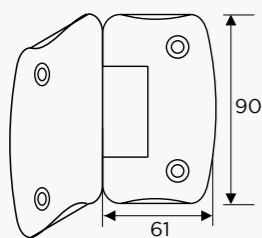

Line Drawing

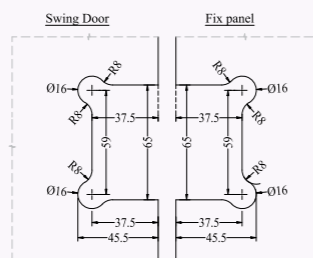

Glass Cutout

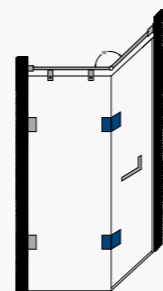

Application Drawing



OSH-OFS-11 STD CP OSH-OFS-11 STD SN

Glass Door Offset Hinge Connected To Wall

Specifications

- Offset positioned pivot line
- Can be used for double action doors also
- Secure holding with glass
- With gaskets to prevent glass damage

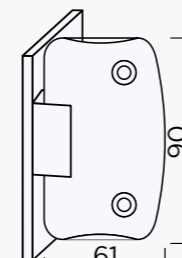

Line Drawing

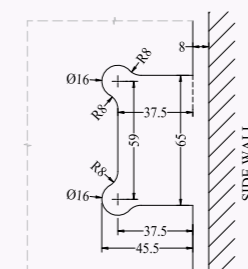

Glass Cutout

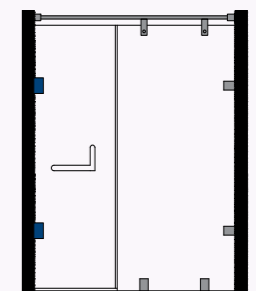

Application Drawing

POINT FIXED SHOWER HINGES



OPSH-11 STD PSS

Wall-to-Glass Hinge

Specifications

- Self centering hinge
- Centrally positioned pivot line
- Secure holding with glass
- With gaskets to prevent glass damage
- Available with SS 304 grade

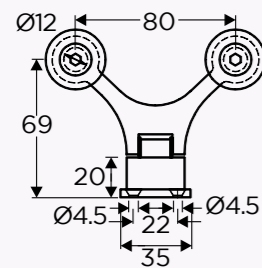

Line Drawing

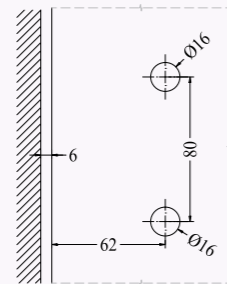

Glass Cutout

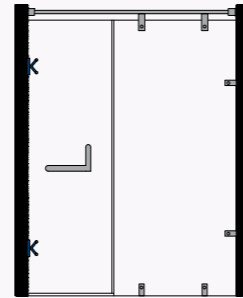

Application Drawing

POINT FIXED SHOWER HINGES



OPSH-55 STD PSS

Wall-to-Glass Bracket (for fixed glass)

Specifications

- Secure holding with glass
- With gaskets to prevent glass damage
- Available with SS 304 grade

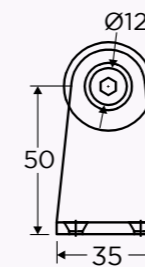

Line Drawing

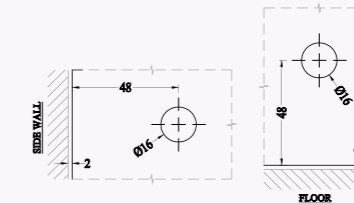

Glass Cutout

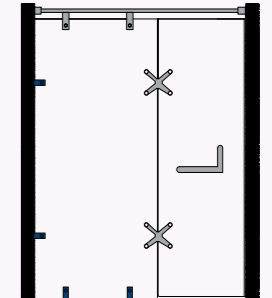

Application Drawing

GLASS CONNECTORS



OPSH-22 STD PSS

Glass-to-Glass Hinge 180°

Specifications

- Self centering hinge
- Centrally positioned pivot line
- Secure holding with glass
- Stainless Steel Grade 304
- With gaskets to prevent glass damage
- Available with SS 304 grade

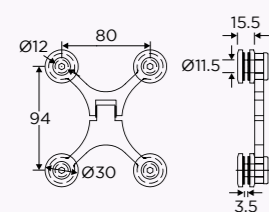

Line Drawing

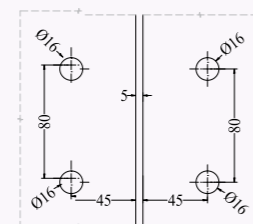

Glass Cutout

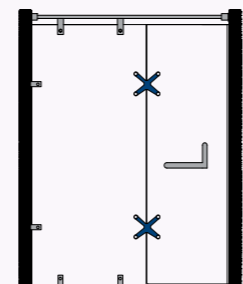

Application Drawing



OGC-1A STD SSS OGC-1A STD PSS

Floor/Wall-to-Glass Connector for 8-10mm Glass

Specifications

- Firm Holding with floor
- New Edge Cut Look
- With gaskets to prevent glass damage
- Available with SS 304 grade

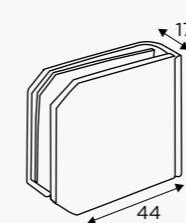

Line Drawing

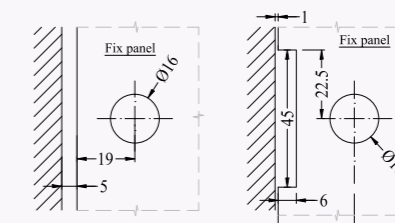

Glass Cutout

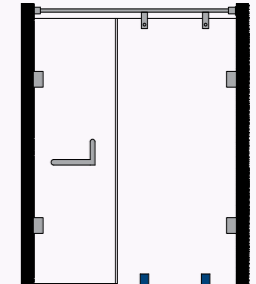

Application Drawing

GLASS CONNECTORS



OGC-2A STD SSS OGC-2A STD PSS

Glass-to-Glass Connector 135° for 8-10mm Glass

Specifications

- Firm Holding with floor
- New Edge Cut Look
- With gaskets to prevent glass damage
- Available with SS 304 grade

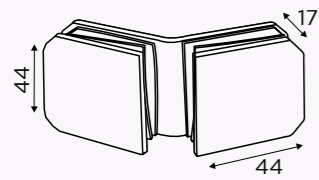

Line Drawing

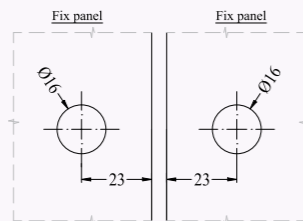

Glass Cutout

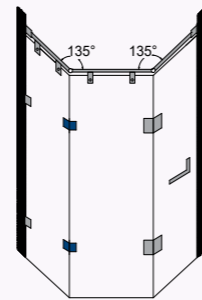

Application Drawing

GLASS CONNECTORS



OGC-4A STD SSS OGC-4A STD PSS

Wall-to-Glass Connector 90° for 8-10mm Glass

Specifications

- Strengthening glass structure
- New Edge Cut Look
- With gaskets to prevent glass damage
- Available with SS 304 grade

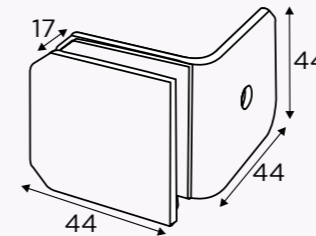

Line Drawing

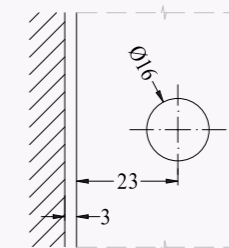

Glass Cutout

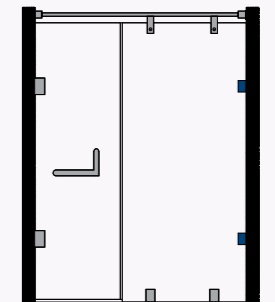

Application Drawing



OGC-3A STD SSS OGC-3A STD PSS

Glass-to-Glass Connector 90° for 8-10mm Glass

Specifications

- Strengthening glass structure
- New Edge Cut Look
- With gaskets to prevent glass damage

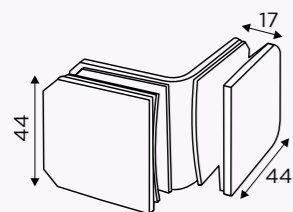

Line Drawing

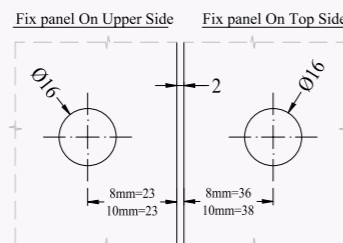

Glass Cutout

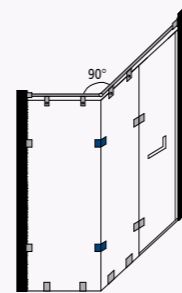

Application Drawing



OGC-5A STD SSS OGC-5A STD PSS

Glass-to-Glass Connector 180° for 8-10mm Glass

Specifications

- Firm Holding with floor
- New Edge Cut Look
- With gaskets to prevent glass damage
- Available with SS 304 grade

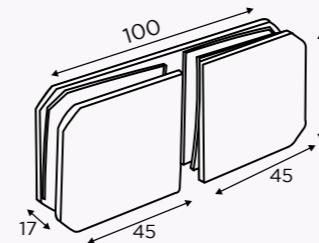

Line Drawing

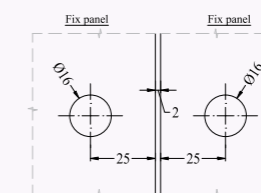

Glass Cutout

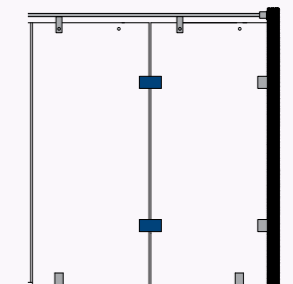

Application Drawing

SHOWER HINGES



OSSH-11-ED STD SSS OSSH-11-ED STD PSS

Wall-to-Glass Hinge

Specifications

- Minimum gap between wall and door
- Secure attachment with wall
- Centrally positioned pivot line
- Can be used for double action doors also
- Secure holding with glass
- With gaskets to prevent glass damage
- Available with SS 304 grade



OSSH-11-ED STD
BM



OSSH-11-ED STD
GOLD G-PVD



OSSH-11-ED STD
ROSE GOLD G-PVD

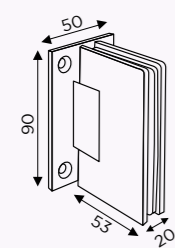

Line Drawing

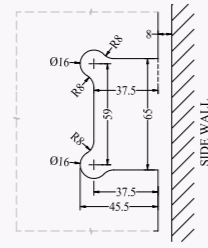

Glass Cutout

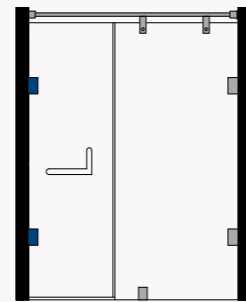

Application Drawing

SHOWER HINGES



OSSH-33-ED STD SSS OSSH-33-ED STD PSS

Glass-to-Glass Hinge 135°

Specifications

- Minimum gap between glasses
- Centrally positioned pivot line
- Secure holding with glass
- Available with SS 304



OSSH-33-ED STD
BM



OSSH-33-ED STD
ROSE GOLD G-PVD

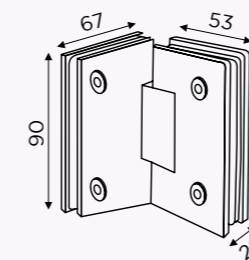

Line Drawing

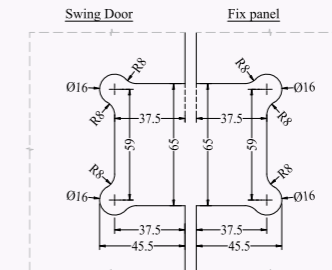

Glass Cutout

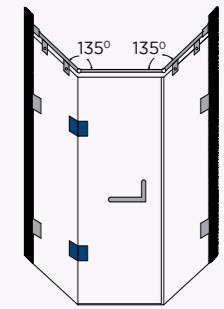

Application Drawing



OSSH-22-ED STD SSS OSSH-22-ED STD PSS

Glass-to-Glass Hinge 180°

Specifications

- Minimum gap between glasses
- Centrally positioned pivot line
- Can be used for double action doors also
- Secure holding with glass



OSSH-22-ED STD
BM



OSSH-22-ED STD
GOLD G-PVD



OSSH-22-ED STD
ROSE GOLD G-PVD

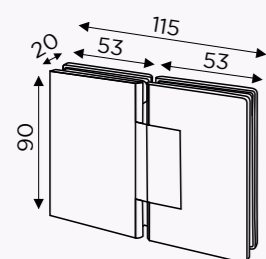

Line Drawing

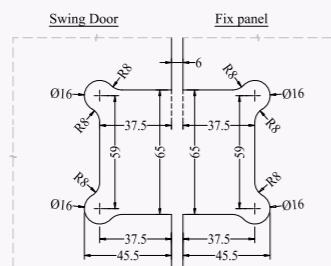

Glass Cutout

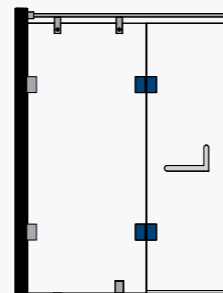

Application Drawing



OSSH-44-ED STD SSS OSSH-44-ED STD PSS

Glass-to-Glass Hinge 90°

Specifications

- Minimum gap between glasses
- Centrally positioned pivot line
- Secure holding with glass
- Available with SS 304



OSSH-44-ED STD
BM



OSSH-44-ED STD
GOLD G-PVD



OSSH-44-ED STD
ROSE GOLD G-PVD

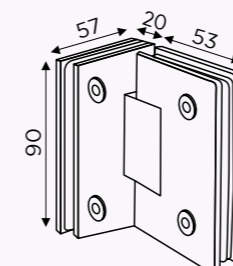

Line Drawing

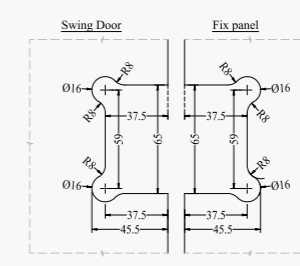

Glass Cutout

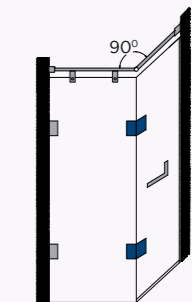

Application Drawing

SHOWER HINGES



OSSH-55-ED STD SSS OSSH-55-ED STD PSS

Wall-to-Glass Bracket (Fixed Glass)

Specifications

- Secure holding with glass
- Stainless Steel Grade 304
- Available with SS 304



OSSH-55-ED STD
BM



OSSH-55-ED STD
GOLD G-PVD



OSSH-55-ED STD
ROSE GOLD G-PVD

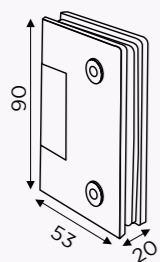

Line Drawing

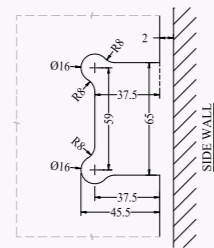

Glass Cutout

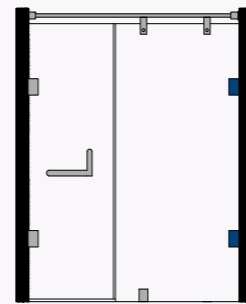

Application Drawing

GLASS CONNECTORS



OGC-1 STD SSS

Glass Connector for Wall / Floor Mounting

Specifications

- Strengthening glass structure
- Firm holding with floor
- Small size for aesthetics
- With gaskets to prevent glass damage
- Available with SS 304



OGC-1 STD
BM



OGC-1 STD
GOLD G-PVD



OGC-1 STD
ROSE GOLD G-PVD

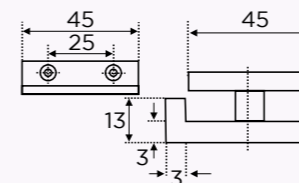

Line Drawing

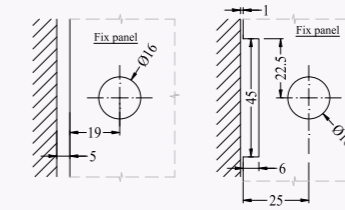

Glass Cutout

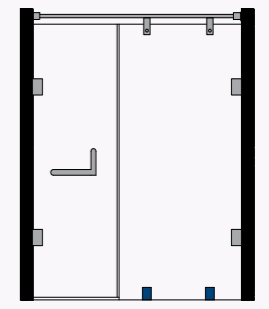

Application Drawing



OSSH-OFS-11-ED STD SSS OSSH-OFS-11-ED STD PSS

Off Set Mounted Side Hinge

Specifications

- Minimum gap between glasses
- Centrally positioned pivot line
- Secure holding with glass
- Available with SS 304

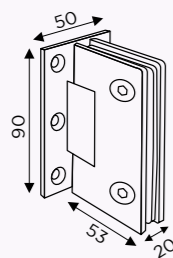

Line Drawing

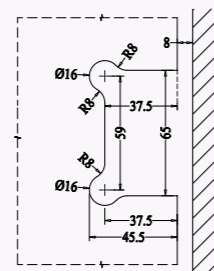

Glass Cutout

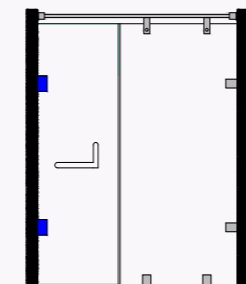

Application Drawing



OGC-2 STD SSS OGC-2 STD PSS

Glass-to-Glass Connector 135°

Specifications

- Strengthening glass structure
- Small size for aesthetics
- With gaskets to prevent glass damage
- Available with SS 304

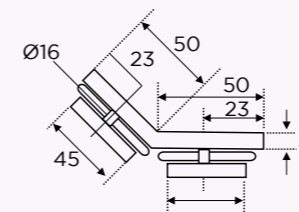

Line Drawing

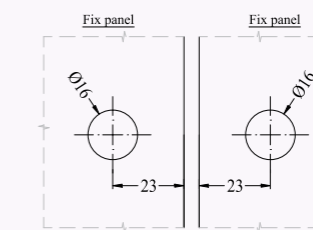

Glass Cutout

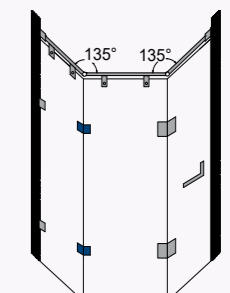

Application Drawing

GLASS CONNECTORS



OGC-3 STD BM

OGC-3 STD SSS

Glass-to-Glass Connector 90°

Specifications

- Strengthening glass structure
- Small size for aesthetics
- With gaskets to prevent glass damage
- Available with SS 304

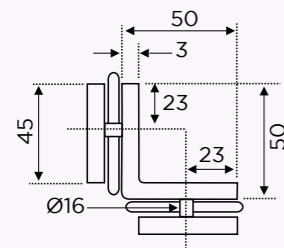

Line Drawing

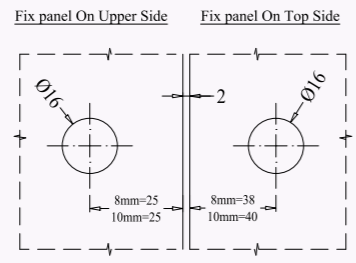

Glass Cutout

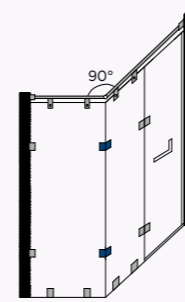

Application Drawing



OGC-4 STD BM



OGC-4 STD GOLD G-PVD



OGC-4 STD ROSE GOLD G-PVD

OGC-4 STD SSS

Wall-to-Glass Connector 90° (Also available in gold plated)

Specifications

- Strengthening glass structure
- Small size for aesthetics
- Available with SS 304

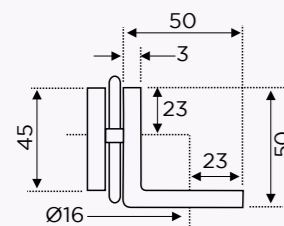

Line Drawing

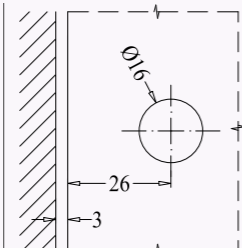

Glass Cutout

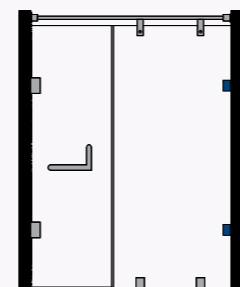

Application Drawing

GLASS CONNECTORS



OGC-5 STD BM



OGC-5 STD GOLD G-PVD



OGC-5 STD ROSE GOLD G-PVD

OGC-5 STD SSS OGC-5 STD PSS

Glass-to-Glass Connector 180°

Specifications

- Strengthening glass structure
- Small size for aesthetics
- With gaskets to prevent glass damage
- Available with SS 304

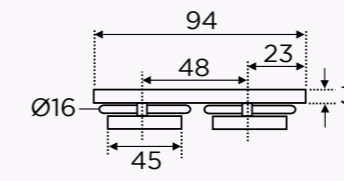

Line Drawing

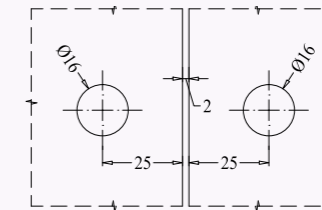

Glass Cutout

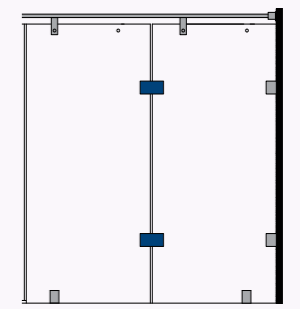

Application Drawing

GLASS CONNECTORS Glass Connector +

Plus Series for Glass Partition



highlight plus range - start from new page

OGC-1+ STD PSS

Wall-to-Glass Connector

Specifications

- Connector Size: 55X60mm
- Sheet Thickness: 3mm
- Glass Thickness: 10-12mm
- Gasket/Washer: PVC
- Finish: - SSS & PSS
- Available with SS 304

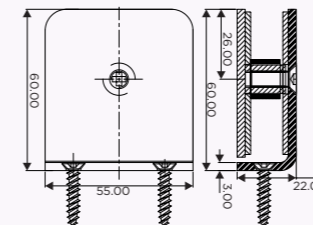

Line Drawing

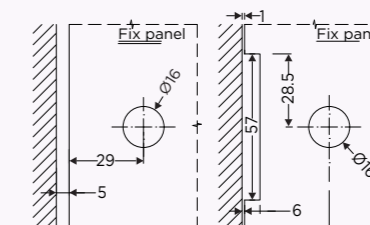

Glass Cutout

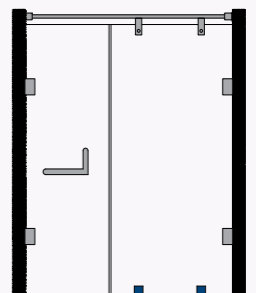

Application Drawing

GLASS CONNECTORS



OGC-333-ED STD
BM

OGC-333-ED STD SSS OGC-333-ED STD PSS

Glass-to-Glass Connector 90°

Specifications

- Strengthening glass structure
- Straight line design for a modern look
- With gaskets to prevent glass damage
- Available with SS 304



Aluminum Material
Tempered Glass
Glass Thickness
8-10mm

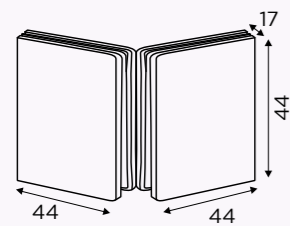

Line Drawing

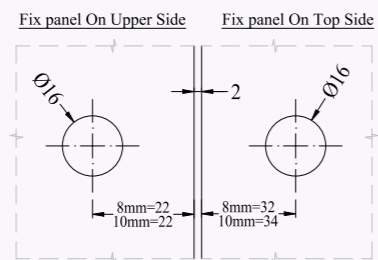

Glass Cutout

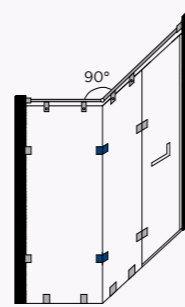

Application Drawing

GLASS CONNECTORS



OGC-555-ED STD
BM

OGC-555-ED STD PSS

Glass-to-Glass Connector 180°

Specifications

- Strengthening glass structure
- Straight Line Design for a Modern look
- With gaskets to prevent glass damage
- Available with SS 304



Aluminum Material
Tempered Glass
Glass Thickness
6-8mm

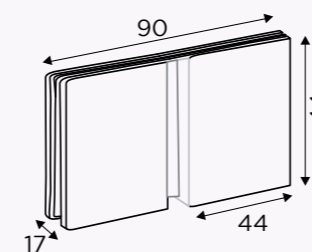

Line Drawing

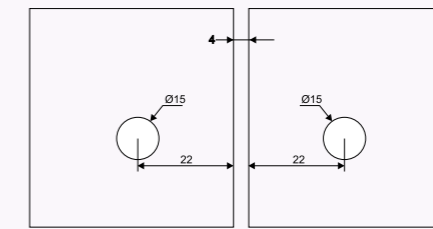

Glass Cutout

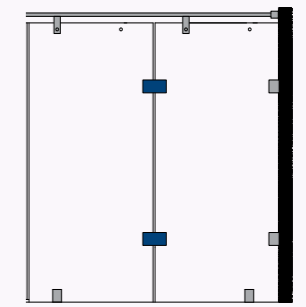

Application Drawing



OGC-444-ED STD
BM

OGC-444-ED STD
ROSE GOLD G-PVD

OGC-444-ED STD SSS OGC-444-ED STD PSS

Wall-to-Glass Hinge 90°

Specifications

- Strengthening glass structure
- Straight Line Design for a Modern look
- With gaskets to prevent glass damage
- Available with SS 304



Aluminum Material
Tempered Glass
Glass Thickness
6-8mm

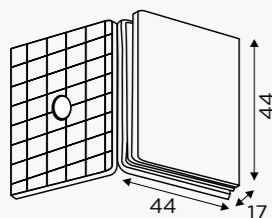

Line Drawing

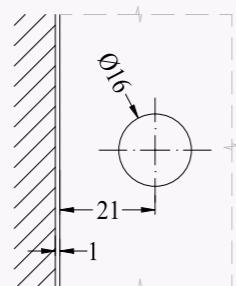

Glass Cutout

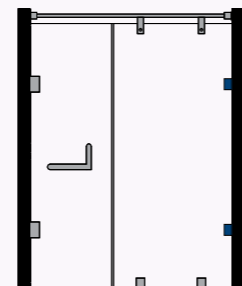

Application Drawing



OGC-1E STD PSS

Glass Connector for Wall / Floor Mounting

Specifications

- Firm Holding with floor
- Straight Line Design for a Modern look
- With gaskets to prevent glass damage
- Available with SS 304



Aluminum Material
Tempered Glass
Glass Thickness
6-8mm

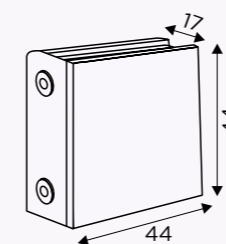

Line Drawing

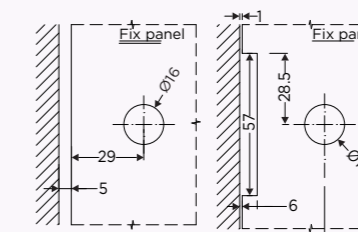

Glass Cutout

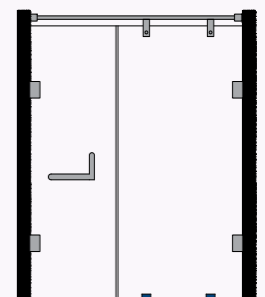

Application Drawing

GLASS CONNECTORS

OGC-2E STD PSS

Glass-to-Glass Connector 135°

Specifications

- Strengthening glass structure
- Straight line design for a modern look
- With gaskets to prevent glass damage
- Available with SS 304

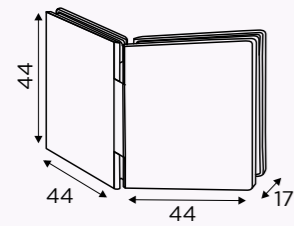

Line Drawing

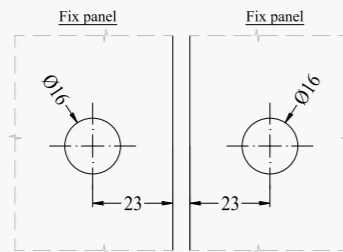

Glass Cutout

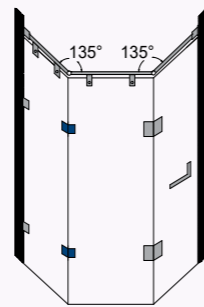

Application Drawing

GLASS CONNECTORS

OGC-4E STD PSS

Wall-to-Glass Connector 90°

Specifications

- Strengthening glass structure
- Straight Line Design for a Modern look
- With gaskets to prevent glass damage
- Available with SS 304

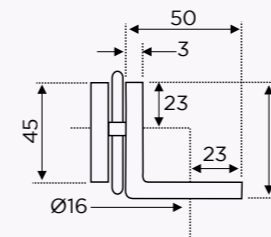

Line Drawing

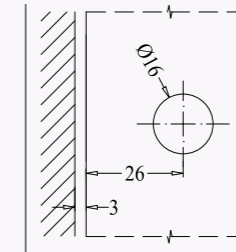

Glass Cutout

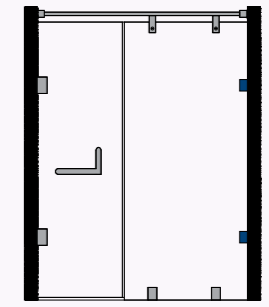

Application Drawing

OGC-3E STD PSS

Glass-to-Glass Connector 90°

Specifications

- Strengthening glass structure
- Straight line design for a modern look
- With gaskets to prevent glass damage
- Available with SS 304

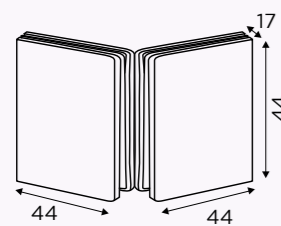

Line Drawing

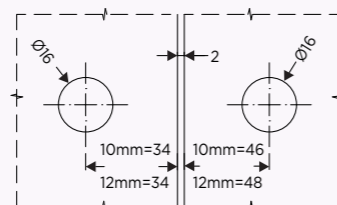

Glass Cutout

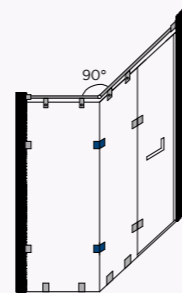

Application Drawing

OGC-5E STD PSS

Glass-to-Glass Connector 180°

Specifications

- Strengthening glass structure
- Straight Line Design for a Modern look
- With gaskets to prevent glass damage
- Available with SS 304

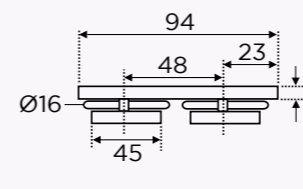

Line Drawing

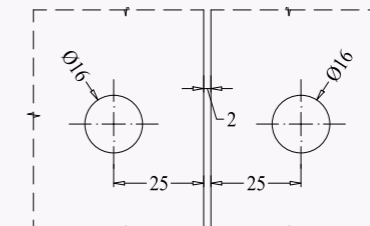

Glass Cutout

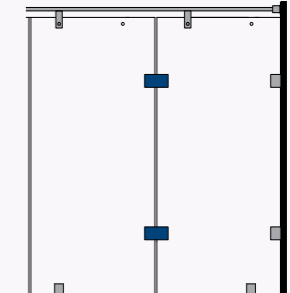

Application Drawing

PREMIUM SHOWER HINGES

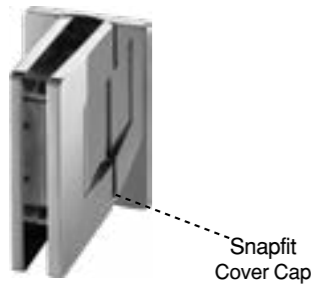

OSH-1S STD CP

Wall to Glass Hinge

Specifications

- Offset positioned pivot line
- Secure holding with glass
- With gaskets to prevent glass damage
- Fittings are to be tightened to the specified torque in all occasions (4mm)
- Available with SS 304

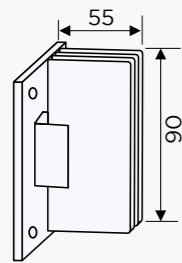

Line Drawing

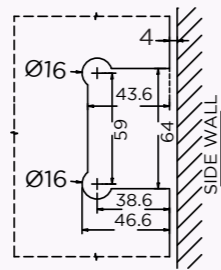

Glass Cutout

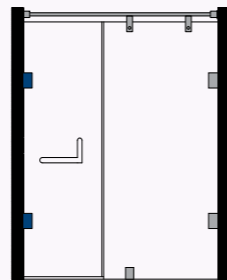

Application Drawing

PREMIUM SHOWER HINGES



OSH-OFS-1S STD CP

Wall-to-Glass off-set Hinge

Specifications

- Offset positioned pivot line
- Secure holding with glass
- With gaskets to prevent glass damage
- Fittings are to be tightened to the specified torque in all occasions (4mm)

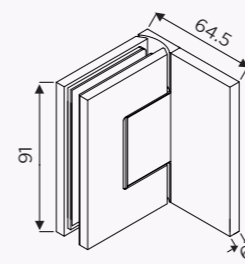

Line Drawing

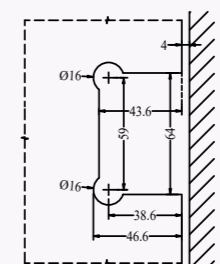

Glass Cutout

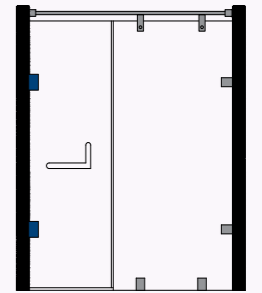

Application Drawing



OSH-2S STD CP

Glass-to-Glass 180° Hinge

Specifications

- Offset positioned pivot line
- Secure holding with glass
- With gaskets to prevent glass damage
- Fittings are to be tightened to the specified torque in all occasions (4mm)
- Available with SS 304

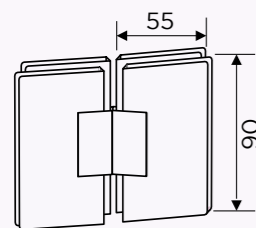

Line Drawing

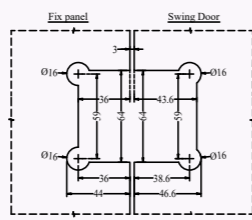

Glass Cutout

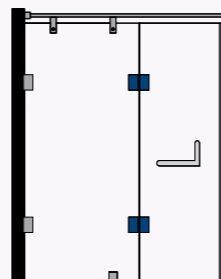

Application Drawing



OSH-5S STD CP

Wall-to-Glass Bracket (for fixed glass)

Specifications

- Offset positioned pivot line
- Secure holding with glass
- With gaskets to prevent glass damage
- Fittings are to be tightened to the specified torque in all occasions (4mm)
- Available with SS 304

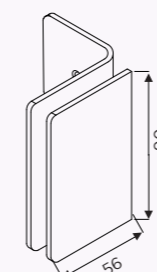

Line Drawing

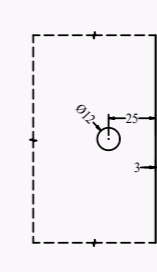

Glass Cutout

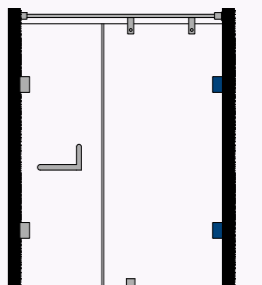

Application Drawing

TOWEL BAR WITH HANDLES



OGH-TB-1S STD PSS

Flattened Towel Bar with Knob

Specifications

- With gaskets to prevent glass damage
- Perfect handling design with superior aesthetic
- Sleek design of 5mm thick flat towel bar outside and knob (50mm Dia, 10mm) inside
- Available with SS 304



OGH-TB-1S STD BM



OGH-TB-1S STD ROSE GOLD G-PVD

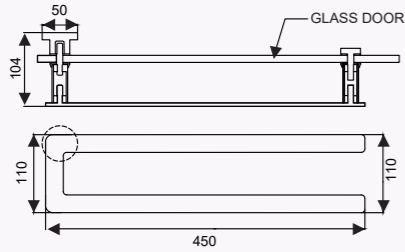

Line Drawing

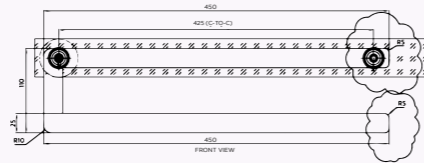

Glass Cutout

TOWEL BAR WITH HANDLES

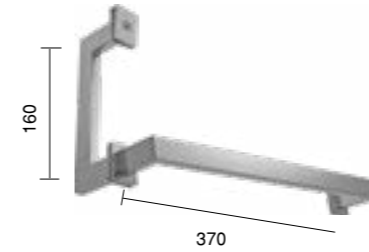

OGH-TB-ED STD PSS

Towel Bar with Handle

Specifications

- With gaskets to prevent glass damage
- Perfect handling design
- Straight line interior for modern look
- Sleek construction
- Towel bar outside and handle inside
- Available with SS 304



BM

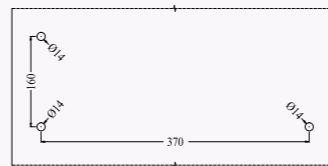

Line Drawing

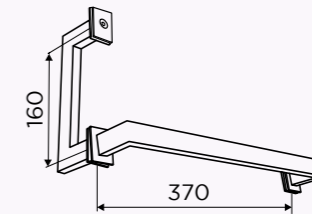

Glass Cutout

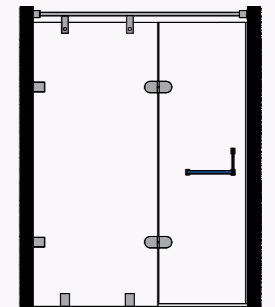

Application Drawing

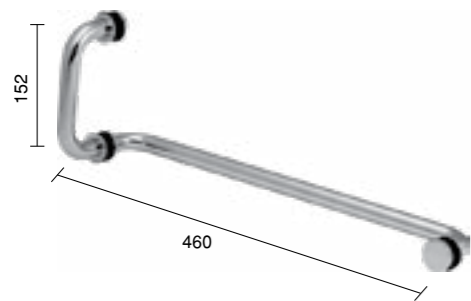

OGH-TB 1 STD SSS

Towel Bar with Handle (Ø19 mm)

Specifications

- With gaskets to prevent glass damage
- Perfect handling design
- Sleek construction
- Towel bar outside and handle inside
- Available with SS 304



OGH-TB-1 STD BM



OGH-TB-1 STD GOLD G-PVD



OGH-TB-1 STD ROSE GOLD G-PVD

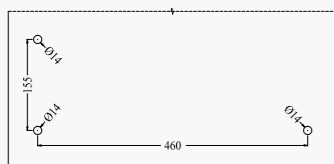

Line Drawing

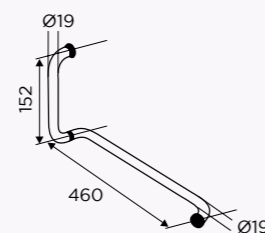

Glass Cutout

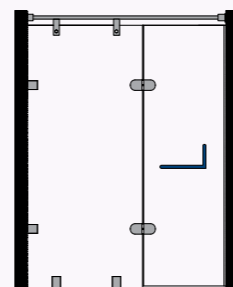

Application Drawing



OGH-TB-3-SWAN CLEAR 250*450 SSS/PSS

Shower Door Handle with Towel Bar

Specifications

- Offset positioned pivot line
- Secure holding with glass
- With gaskets to prevent glass damage
- Fittings are to be tightened to the specified torque in all occasions (4mm)
- Available with SS 304

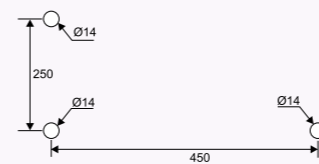

Line Drawing

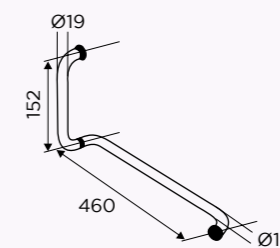

Glass Cutout

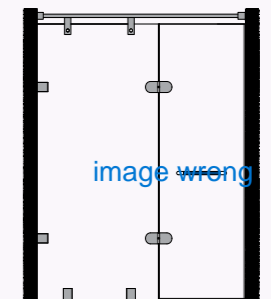

Application Drawing

TOWEL BAR WITH HANDLES



OGH-TB-3-SWAN BLUE 250*450 PSS

Shower Door Handle with Towel Bar

Specifications

- Offset positioned pivot line
- Secure holding with glass
- With gaskets to prevent glass damage
- Fittings are to be tightened to the specified torque in all occasions (4mm)
- Available with SS 304

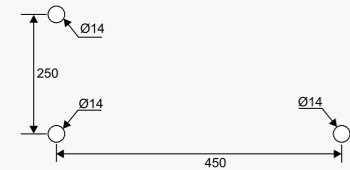

Line Drawing

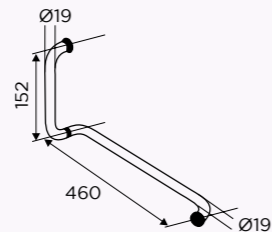

Glass Cutout

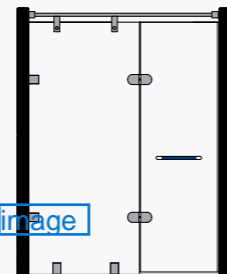

Application Drawing

TOWEL BAR WITH HANDLES

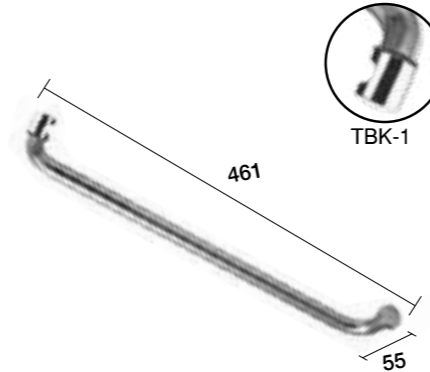

OGH-TBK-1 PSS

Towel Bar with Knob

Specifications

- Offset positioned pivot line
- Secure holding with glass
- With gaskets to prevent glass damage
- Fittings are to be tightened to the specified torque in all occasions (4mm)
- Available with SS 304



Line Drawing

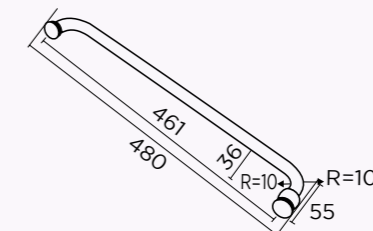

Glass Cutout

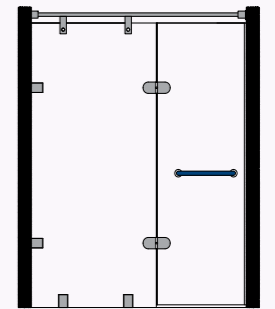

Application Drawing

OGH-TB-4 PSS

Shower Door Handle with Towel Bar

Specifications

- With gaskets to prevent glass damage
- Perfect handling design
- Straight line interior for modern look
- Sleek construction
- Towel bar out side and handle inside
- Available with SS 304

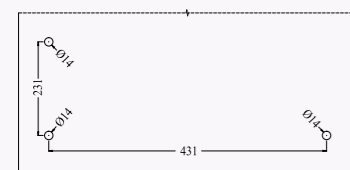

Line Drawing

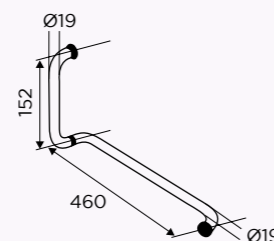

Glass Cutout

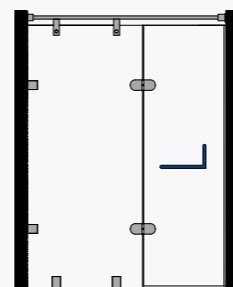

Application Drawing

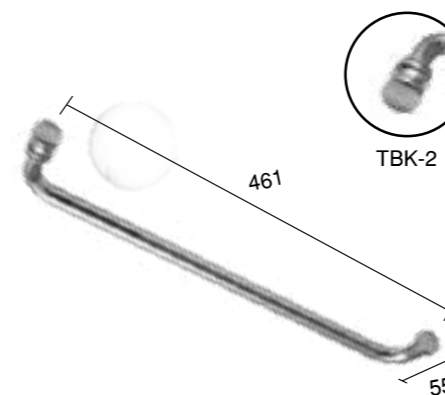

OGH-TBK-2 SSS

OGH-TBK-2 PSS

Towel Bar with Knob

Specifications

- With gaskets to prevent glass damage
- Perfect handling design
- Sleek construction
- Towel bar out side and door knob inside

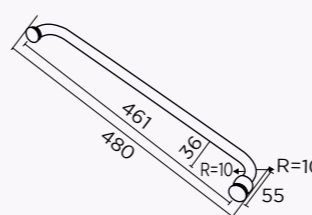

Line Drawing



Glass Cutout

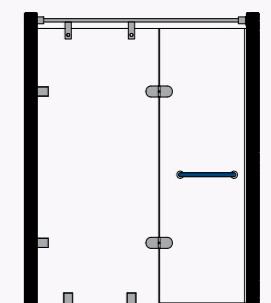

Application Drawing

TOWEL BAR WITH HANDLES

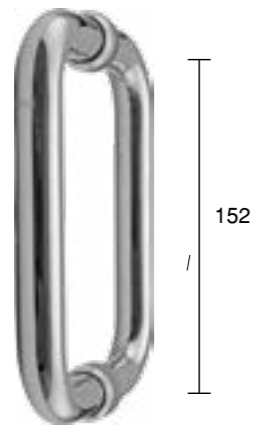

OGH-11 19x171 SSS

Shower Door Handle

Specifications

- With gaskets to prevent glass damage
- Sleek construction
- Handle on both sides
- Can be used on sliding door also
- Available with SS 304

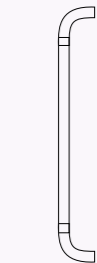

Line Drawing



Glass Cutout

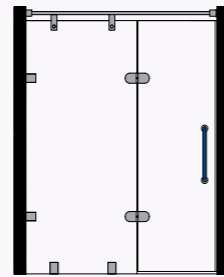

Application Drawing

SHOWER KNIGHT HEAD FITTINGS



OSKH-1 STD SSS OSKH-1 STD PSS

Reinforcing Rod with Wall Connector (Also available in gold plated)

Specifications

- Perfect radius for the pipe
- Grub screws to hold the pipe
- Firm seating with wall
- Available with SS 304



OSKH-1 STD
BM



OSKH-1 STD
GOLD G-PVD



OSKH-1 STD
ROSE GOLD G-PVD

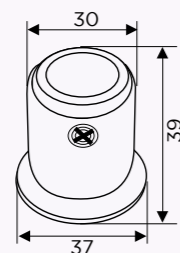

Line Drawing

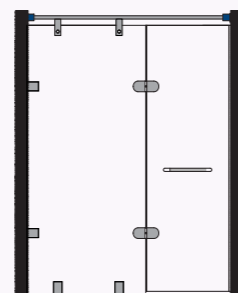

Application Drawing

SHOWER KNIGHT HEAD FITTINGS



OSKH-2 STD SSS OSKH-2 STD PSS

Reinforcing Rod Support from Glass Through and Through (Also available in gold plated)

Specifications

- Available for 19mm & 25mm pipe
- Perfect radius for the pipe
- Firm seating with glass
- Through hole for the pipe
- Available with SS 304



OSKH-2 STD
BM



OSKH-2 STD
GOLD G-PVD



OSKH-2 STD
ROSE GOLD G-PVD

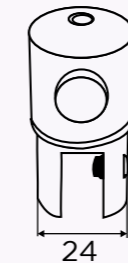

Line Drawing

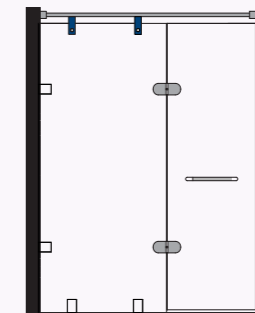

Application Drawing



OSKH-2A STD SSS OSKH-2A STD PSS

Reinforcing Rod Support from Glass One Side Blind

Specifications

- Available for 19mm & 25mm pipe
- Grub screws to hold the pipe
- Blind hole on one end
- For terminating the pipe
- Available with SS 304

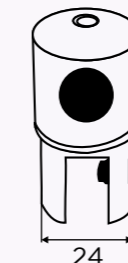

Line Drawing

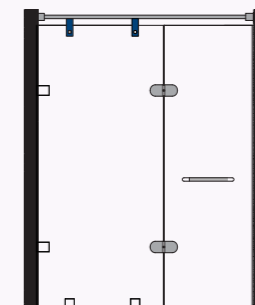

Application Drawing

SHOWER KNIGHT HEAD FITTINGS



OSKH-3 STD SSS OSKH-3 STD PSS

Reinforcing Rod Connector Universal

Specifications

- Available for 19mm & 25mm pipe
- Grub screws to hold the pipe
- Adjustable at any angle
- Available with SS 304



OSKH-3 STD
BM

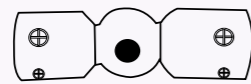

Line Drawing

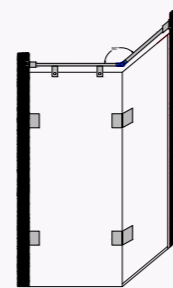

Application Drawing

SHOWER KNIGHT HEAD FITTINGS



OSKH-1C STD PSS

Reinforcing Bars cum Glass Support Wall Bracket

Specifications

- Firm fixing to glass & Re-inforcement bar
- Compatible to 019 mm pipe
- Suitable to 8mm & 10mm Thick Glass
- Stainless Steel Grade 304 material
- Available with SS 304



Line Drawing

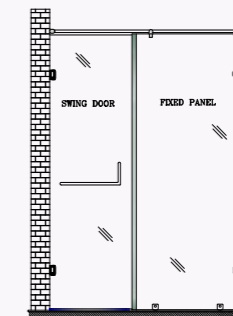

Application Drawing

OSKH-ACC-19 2mtr SSS/PSS OSKH-ACC-19 3mtr SSS/PSS OSKH-ACC-19 3mtr BM

Re-inforcing Rod 19mm Diameter

Specifications

- 19mm/25mm outer diameter pipe
- Available Length 2mtr. & 3mtr.
- Available with SS 304



OSKH-ACC-19
BM



OSKH-ACC-19
GOLD G-PVD



OSKH-ACC-19
ROSE GOLD G-PVD

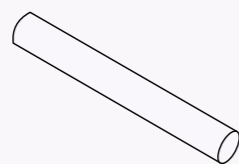

Line Drawing

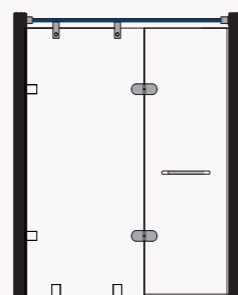

Application Drawing



OSKH-T STD PSS

Reinforcement Bars for Adjoining Shower Enclosures

Specifications

- Grub screws to hold the pipe
- Suitable for 19mm rod/pipe
- Connect the Rod at 'T' type Junctions
- Available with SS 304

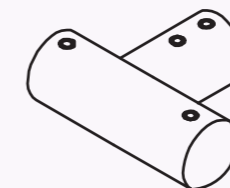

Line Drawing

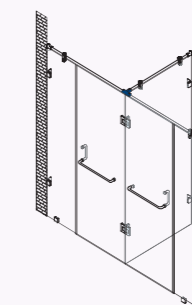

Application Drawing

SHOWER KNIGHT HEAD FITTINGS



OSKH-3C STD PSS

Pipe Connectors at any angle for Glass Stabilization

Specifications

- Secure holding of shower glass panels & Re-inforcement bar
- Compatible to 019 mm pipe
- Suitable to 8mm & 10mm Thick Glass
- Adjustable at any angle
- Available with SS 304

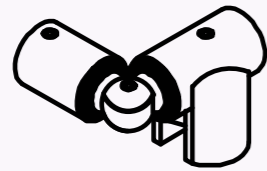

Line Drawing

[start from new page](#)

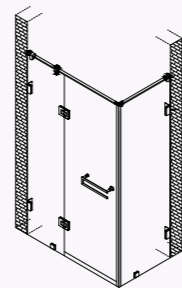

Application Drawing

EDGE LINE KNIGHT HEAD FITTINGS



OSSKH-1-ED STD PSS

Wall-to-track Connector

Specifications

- For mounting with wall
- Rectangular design
- With two grub screws to prevent relative movement
- Available with SS 304



OSSKH-1-ED STD BM



OSSKH-1-ED STD GOLD G-PVD



OSSKH-1-ED STD ROSE GOLD G-PVD

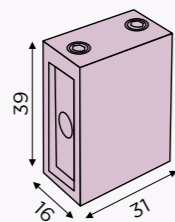

Line Drawing

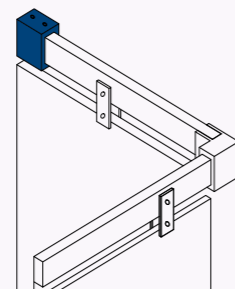

Application Drawing

EDGE LINE KNIGHT HEAD FITTINGS



OSSKH-2-ED STD PSS

Track to Glass Connector

Specifications

- For mounting on to glass
- Rectangular design
- With grub screws to prevent relative movement
- Available with SS 304



OSSKH-2-ED STD BM



OSSKH-2-ED STD GOLD G-PVD



OSSKH-2-ED STD ROSE GOLD G-PVD

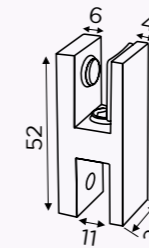

Line Drawing

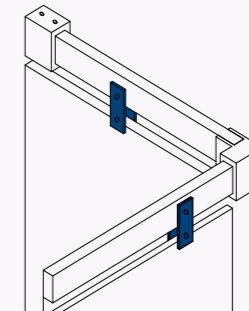

Application Drawing



OSSKH-3-ED STD PSS

Glass-to-track end Connector
Track-to-Track 90° Connector

Specifications

- Glass to track end connector
- With grub screws to prevent relative movement
- Available with SS 304



OSSKH-3-ED STD BM



OSSKH-3-ED STD GOLD G-PVD



OSSKH-3-ED STD ROSE GOLD G-PVD

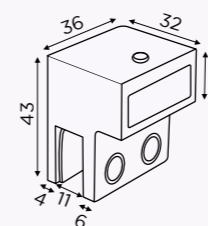

Line Drawing

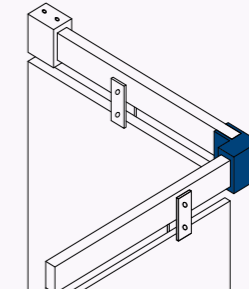

Application Drawing

EDGE LINE KNIGHT HEAD FITTINGS

OSKH-3C STD PSS

Pipe Connectors at any angle for Glass Stabilization

Specifications

- Secure holding of shower glass panels & Re-inforcement bar
- Compatible to 019 mm pipe
- Suitable to 8mm & 10mm Thick Glass
- Adjustable at any angle
- Available with SS 304

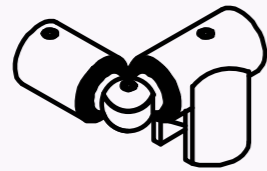

Line Drawing

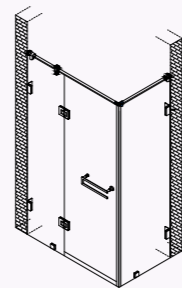

Application Drawing

DOOR KNOBS

ODK-1 STD PSS

Glass Door Knob

Specifications

- With gaskets to prevent glass damage
- Sleek construction
- Perfect handling design

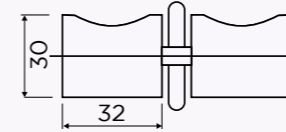

Line Drawing

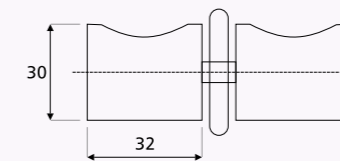

Glass Cutout

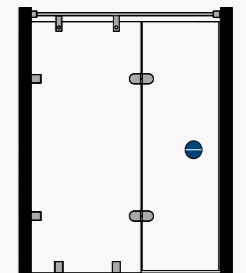

Application Drawing

OSSKH-ACC-25T-ED 1.65mtr PSS

OSSKH-ACC-25T-ED 2mtr PSS

OSSKH-ACC-25T-ED 3Mtr PSS

Connector Track

Specifications

- Rectangular design
- Available in 1.65, 2 & 3 mtr. length
- Available with SS 304



OSSKH-ACC-25T-ED STD
BM



OSSKH-ACC-25T-ED
GOLD G-PVD



OSSKH-ACC-25T-ED
ROSE GOLD G-PVD

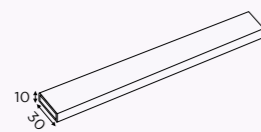

Line Drawing

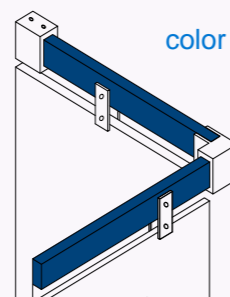

Application Drawing

ODK-2 STD SSS

ODK-2 STD PSS

Glass Door Knob

Specifications

- With gaskets to prevent glass damage
- Sleek construction
- Perfect handling design

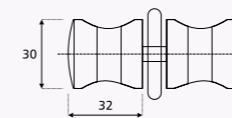

Line Drawing

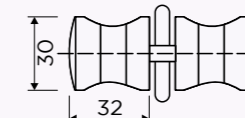

Glass Cutout

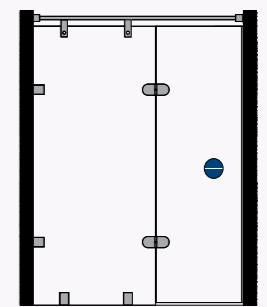

Application Drawing

DOOR KNOBS



ODK-22 STD PSS

Glass Door Knob

Specifications

- With gaskets to prevent glass damage
- Sleek construction
- Perfect handling design
- Available with SS 304 Grade

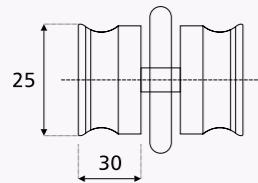

Line Drawing

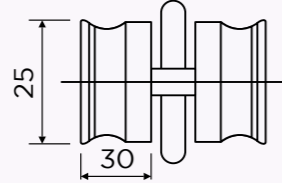

Glass Cutout

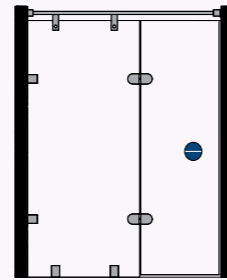

Application Drawing



ODK-44 STD SSS ODK-44 STD PSS

Glass Door Knob

Specifications

- With gaskets to prevent glass damage
- Sleek construction
- Perfect handling design

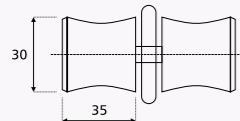

Line Drawing

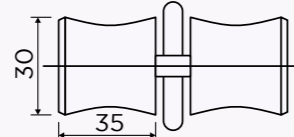

Glass Cutout

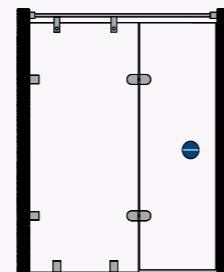

Application Drawing

SHOWER THRESHOLD



OZ-ST-10mm 2m SSS

Floor Mounted Glazing Profile For Fixed Glass

Specifications

- Secure fixing of glass
- Aesthetically appealing
- Separate for 8mm & 10mm glass
- Available with SS 304 Grade

Line Drawing

Glass Cutout

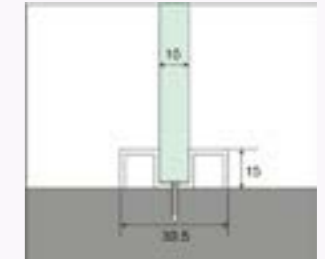

Application Drawing



OZ-ST-ACC-CP-10mm 2m SSS

Cover Profile for OZ-ST-8mm & 10mm

Specifications

- Fills cavity of glazing profile where door is there
- Aesthetically appealing
- Separate for 8mm & 10mm glass
- Available with SS 304 Grade

Line Drawing

Glass Cutout



Application Drawing

PLASTIC PROFILES

Available for 8, 10 & 12mm Glass
Standard Length - 2.2mt

OPS-1 STD

Wall Seal

Specifications

- Transparent with Soft Lip.
- Separate Product for 8, 10 and 12mm Glass.

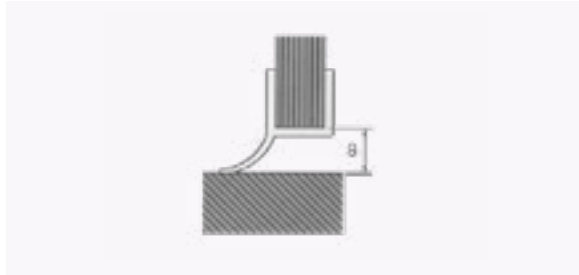

OPS-2 STD

Central Seal

Specifications

- Transparent with Soft Lip.
- For Sealing Double Action Door and Wall.
- Separate Product for 8, 10 and 12mm Glass.

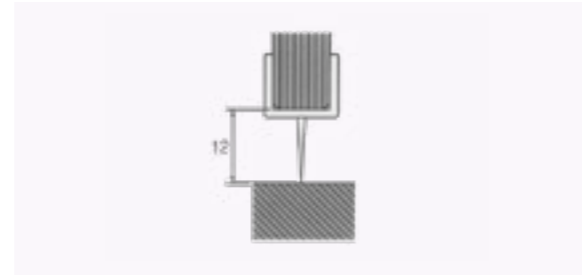

OPS-3 STD (SOFT) OPS-3-10F 10MM STD

Central 180° Weather Seal (Soft)

Specifications

- Used between Fix Panel & Door Panel.
- Separate Product for 8, 10 and 12mm Glass.



OPS-3 STD BM

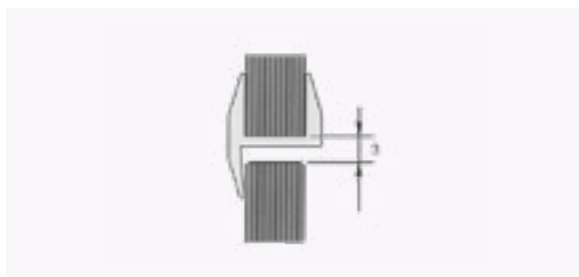

OPS-4 STD OPS-4-10F 12MM STD

Central 180° Weather Seal

Specifications

- Separate Product for 8, 10 and 12mm Glass.
- Also available: in 3mtr. Length.



OPS-4 STD BM

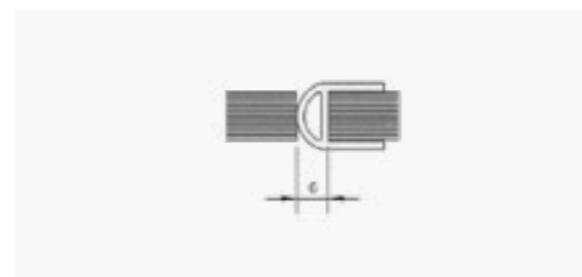

PLASTIC PROFILES

Available for 8, 10 & 12mm Glass
Standard Length - 2.2mt

OPS-5 STD

Soft Nose Seal

Specifications

- Separate Product for 8 and 10mm Glass.



OPS-6 STD

Water Dispersal Seal

Specifications

- Separate Product for 8 and 10mm Glass.

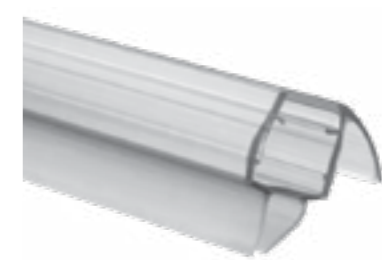

OPS-7 STD

Water Dispersal Seal

Specifications

- Separate Product for 8 and 10mm Glass.

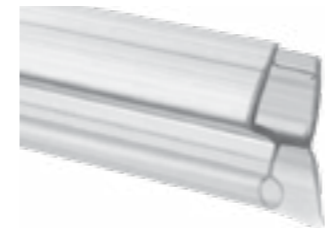

OPS-8 STD (Hard)

Central 180° Weather Seal

Specifications

- Used between Fix Panel & Door Panel.
- Seal also acts as Door Stopper. Door can be made single action.
- Separate Product for 8,10 and 12mm Glass.



OPS-8 STD BM



PLASTIC PROFILES

Available for 8, 10 & 12mm Glass
Standard Length - 2.2mt

OPS-9 STD

Offset Lip Seal

Specifications

- Separate Product 8, 10 and 12mm Glass.

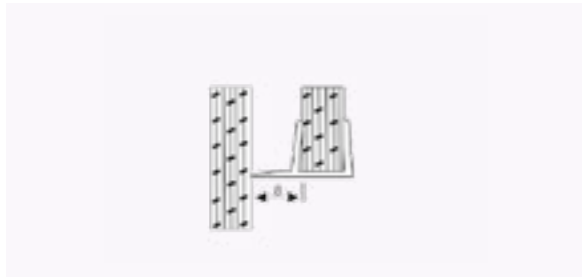

OPS-M1 STD

180° Magnetic Seal

Specifications

- Separate Product for 8, 10, and 12mm Glass.
- Supplied in Pairs.

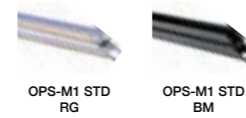

OPS-M2 STD

135° Magnetic Seal

Specifications

- Separate Product for 8 and 10mm Glass.

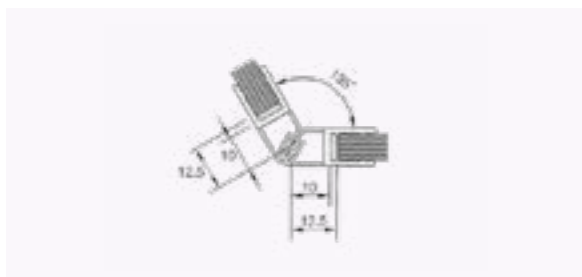

OPS-M3 STD

90° Magnetic Seal

Specifications

- Separate Product for 8, 10, and 12mm Glass.
- Supplied in Pairs.

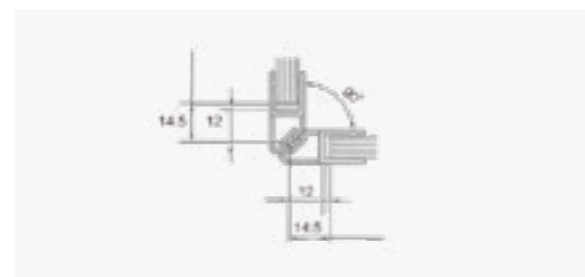
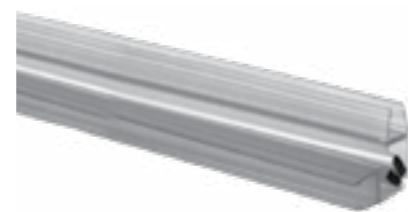

PLASTIC PROFILES

Available for 8, 10 & 12mm Glass
Standard Length - 2.2mt

OPS-11 STD

Offset Lip Seal

Specifications

- Separate Product 8, 10 and 12mm Glass.

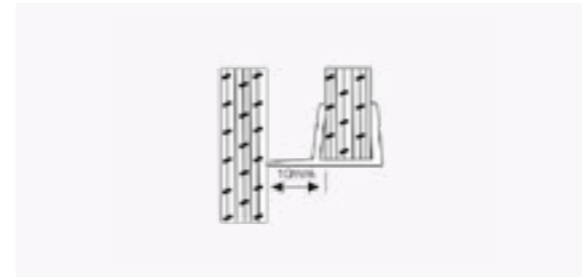

OPS-SL-BR-11 10MM STD OPS-SL-BR-11 12MM STD

Brush Seal (Central)

Specifications

- For 10 and 12mm Glass Thickness.

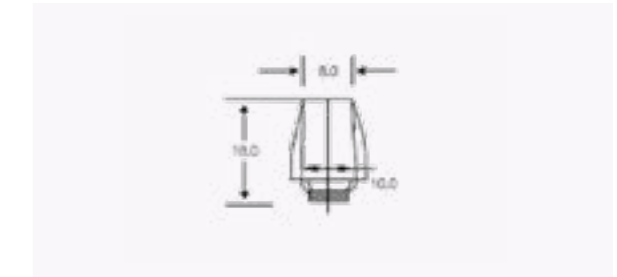

OPS-SL-11L 10ft STD

Offset Lip Seal

Specifications

- Glass lip seal is an adhesive seal for frameless glass doors with a simple and quick installation system.
- The width of the seal can be reduced by each millimeter simply by tearing off part of the lip.

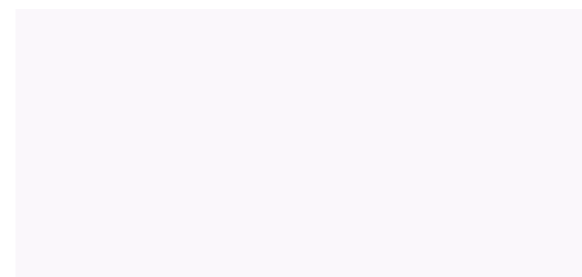

OPS-SL-BR-22-10ft 12MM STD OPS-SL-BR-22N-10ft 12MM

Weather Seal(Sliding Doors)

Specifications

- For 10 and 12mm Glass Thickness.
- Also available in 3mtr.

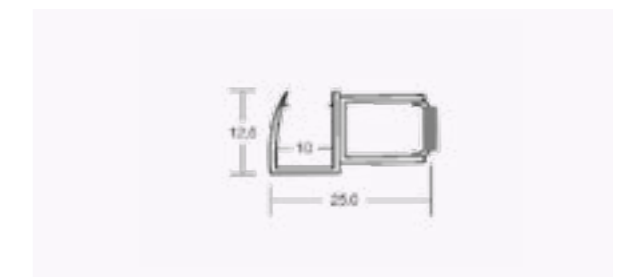

OSL-ED-SYS-11

Sliding Shower Enclosure 180°

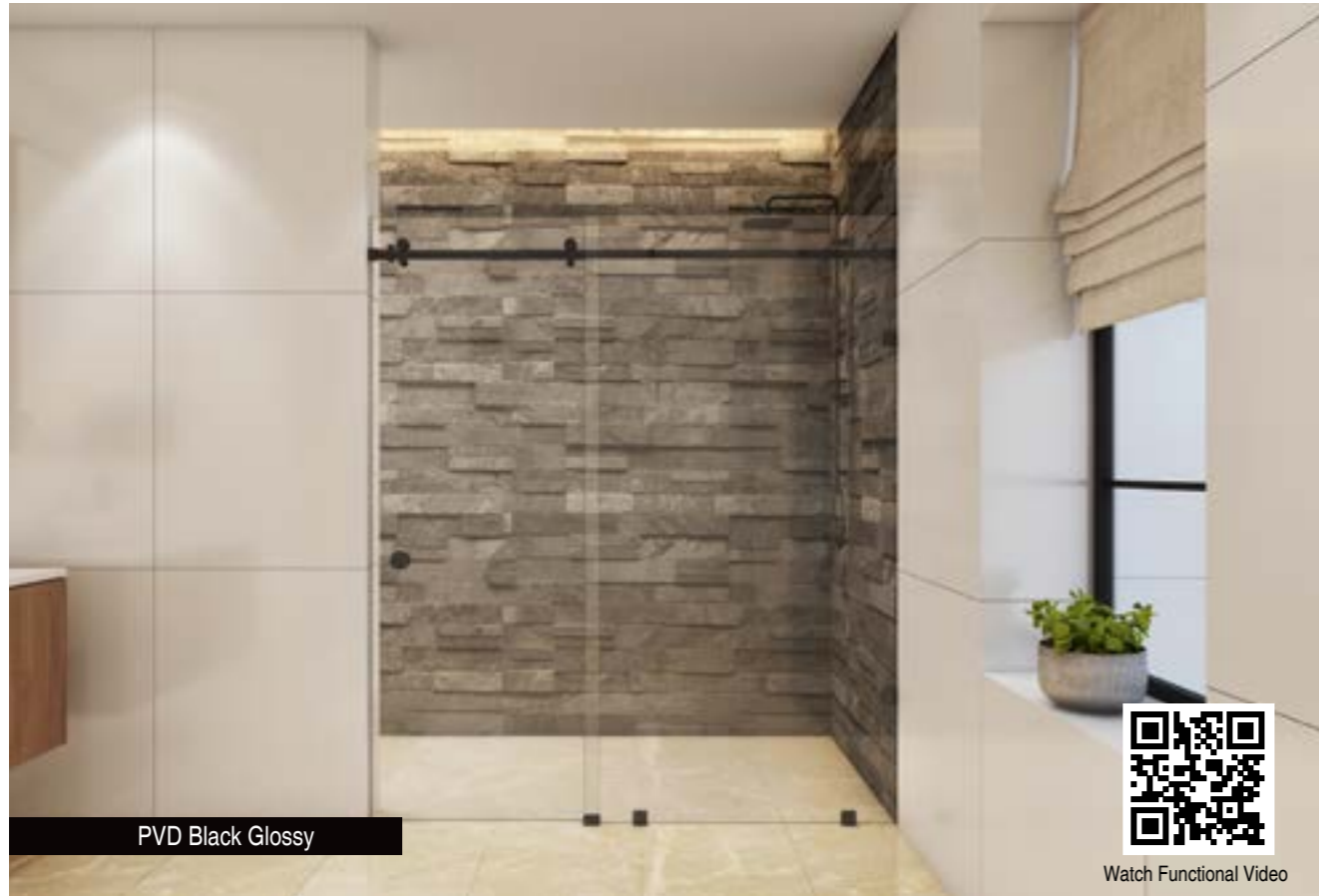

PVD Black Glossy

Watch Functional Video



Polished Stainless Steel

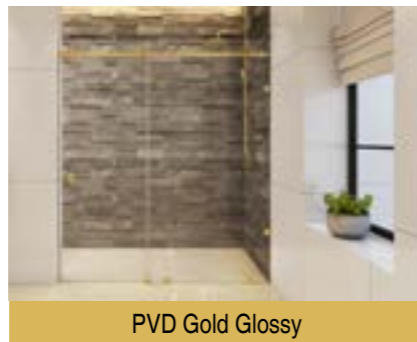

PVD Gold Glossy

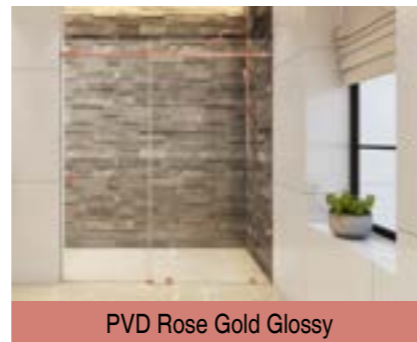

PVD Rose Gold Glossy



SL-ED-11-A3-STOPPER
Stopper with bumper



OSSKH-1-ED - TRACK TO GLASS HOLDER
Firm grip with glass & track



SL-ED-11-A1 - SLIDING DOOR ROLLER
Independent needle bearings



SL-HN-50 STD SLIDING DOOR HANDLE
Perfect round design with good grip



SL-ED-11-TRACK - SLIDING TRACK
Standard length 1.65mtr. & 2.00mtr.



SL-ED-11-A2 - TRACK TO GLASS HOLDER
Firm grip with glass & track



OGC-4 - GLASS CONNECTOR
Shower screen brackets wall-to-glass 90°



SL-ED-11-A4 - FLOOR GUIDE
Double guide to hold fixed and guide moving glass



OGC-1
Shower Screen Brackets for Floor Mounting

TYPICAL LAYOUT

Sliding Shower Enclosure 180°

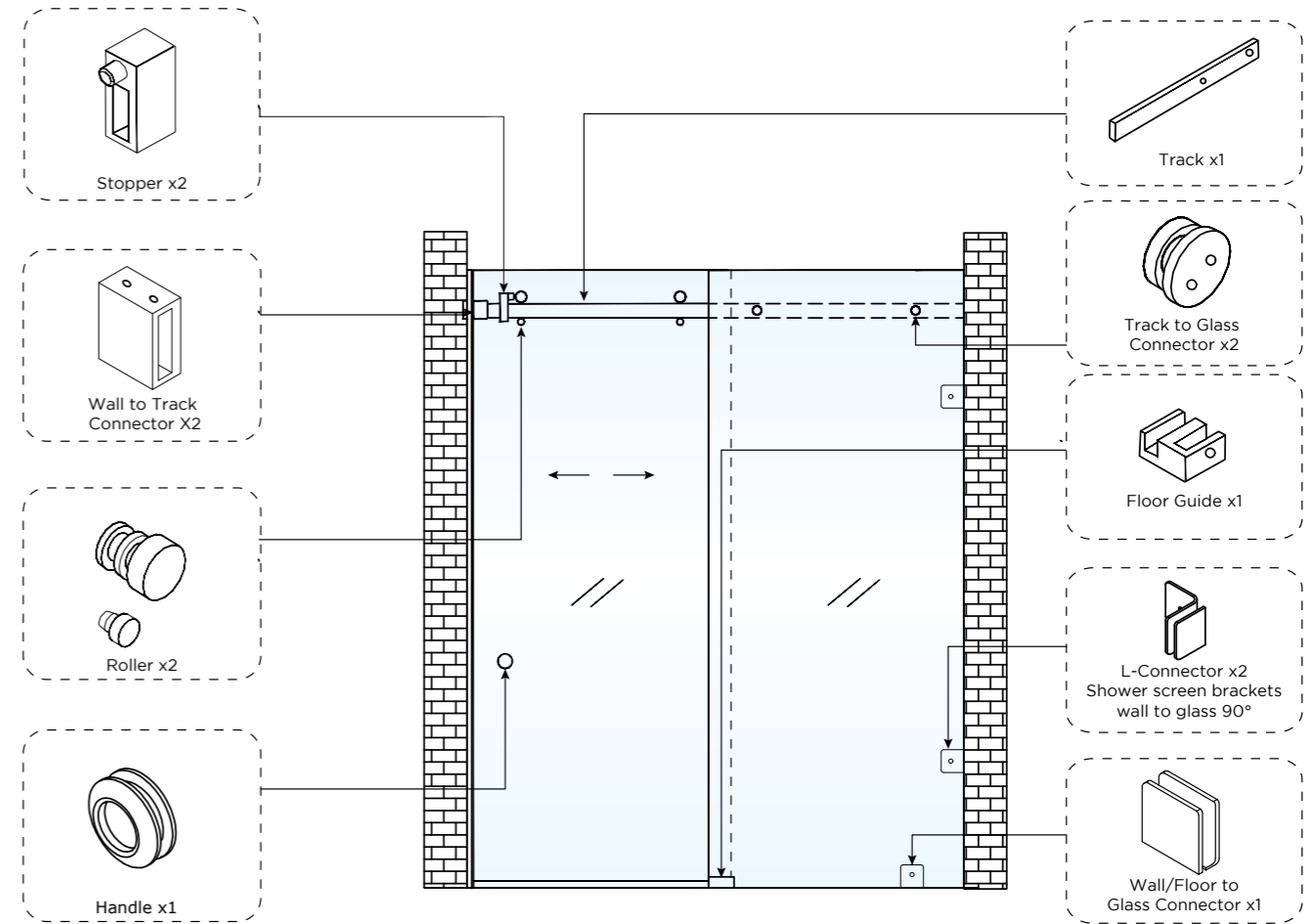

Stopper x2

Wall to Track Connector X2

Roller x2

Handle x1

Track x1

Track to Glass Connector x2

Floor Guide x1

L-Connector x2
Shower screen brackets wall to glass 90°

Wall/Floor to Glass Connector x1

TECHNICAL DATA

Glass Type	Tempered Glass
Glass Thickness	8, 10mm
Max. Door Height	2100mm
Max. Door Weight	40-45kg
Applications	Sliding Shower Cubicle
Standard Finishes	PSS/ PVD Rose gold Glossy/ PVD Gold Glossy / BM
Material	Stainless Steel

S.No.	Description	QTY.
01	Stopper	2
02	Wall to Track Connector	2
03	Roller	2
04	Handle	1
05	Track	1
06	Track to Glass Connector	2
07	Floor Guide	1
08	L-Connector	2
09	Wall/Floor to Glass Connector	1

ELIZABETH SL-22

E-Series Wall to Wall System

OSSL.SYS.1E 2M CP / OSSL.SYS.1E 3M CP



Hidden Roller

Wall-to-Glass Connector 90°

Floor Guide



TRACK 2mtr
Aluminium top track



TRACK 3mtr
Aluminium top track



ROLLER
Ø35 Stainless steel knob clamp roller



SL-HN-50 STD SSS
SLIDING DOOR HANDLE
Perfect round design with good grip



FLOOR GUIDE
Guide the sliding glass door



STOPPER
Firm grip with glass & track



OGC-4 - GLASS CONNECTOR
L-Connector



OGC-1
U Type connector

TYPICAL LAYOUT

E-Series Wall to Wall System

OSSL.SYS.1E 2M CP / OSSL.SYS.1E 3M CP
Wall to Wall System

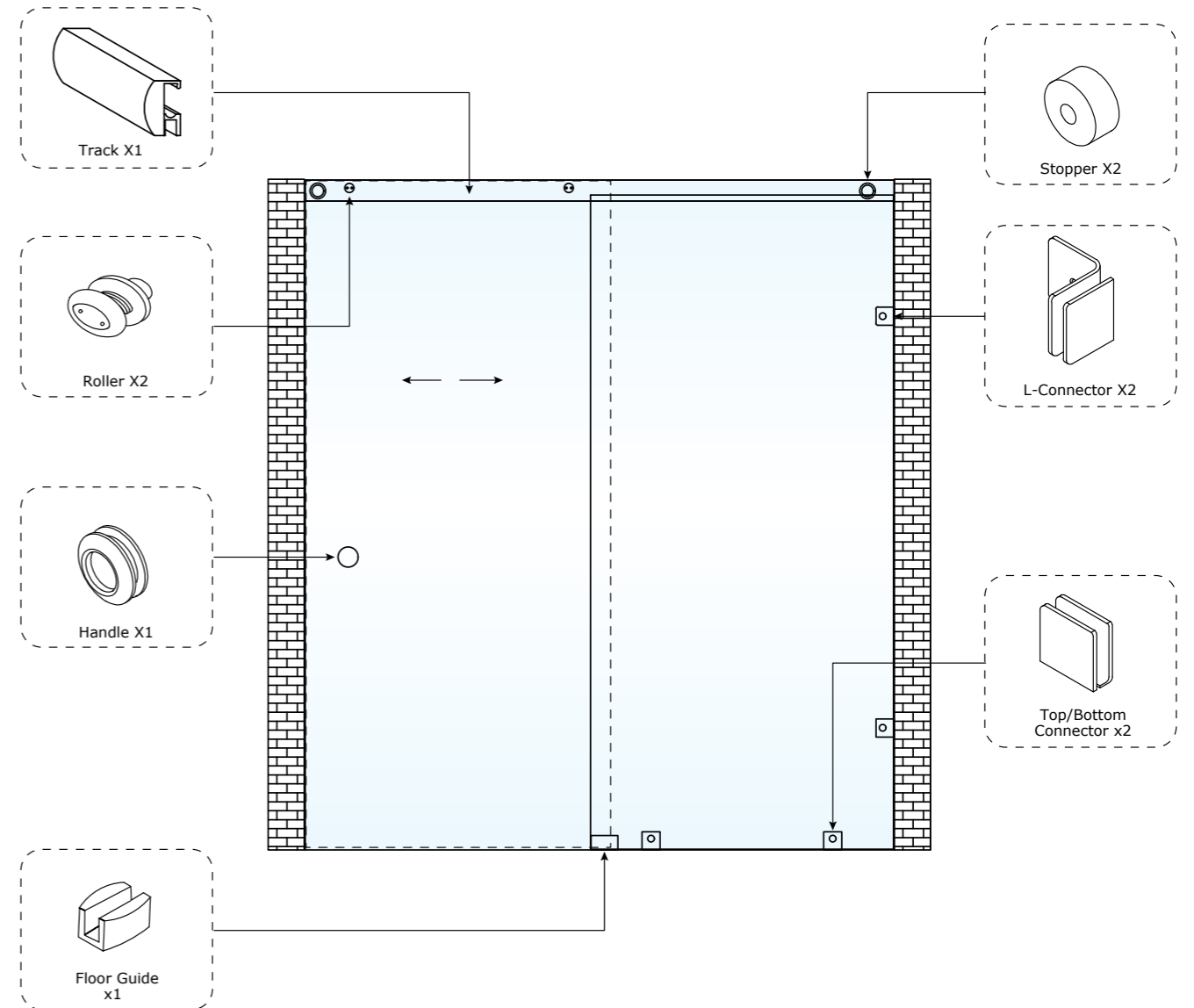

TECHNICAL DATA

Glass Type	Tempered Glass
Glass Thickness	8, 10mm
Max. Door Height	2100mm
Max. Door Weight	40-45kg
Applications	Sliding Shower Cubicle
Standard Finishes	CP
Material	Aluminum

S.No.	Description	QTY.
01	Track	1
02	Roller	2
03	Handle	1
04	Floor Guide	1
05	Stopper	2
06	L-Connector	2
07	Top/Bottom Connector	2

ELIZABETH SL-33

E-Series Corner Entry System

OSSL.SYS.90.1E.1.65mx2 CP



Chrome Polished

Watch Functional Video



Sliding Door Handle

Wall-to-Glass Connector

Floor-to-Glass Connector



TYPICAL LAYOUT

E-Series Corner Entry System

OSSL.SYS.90.1E.1.65mx2 CP

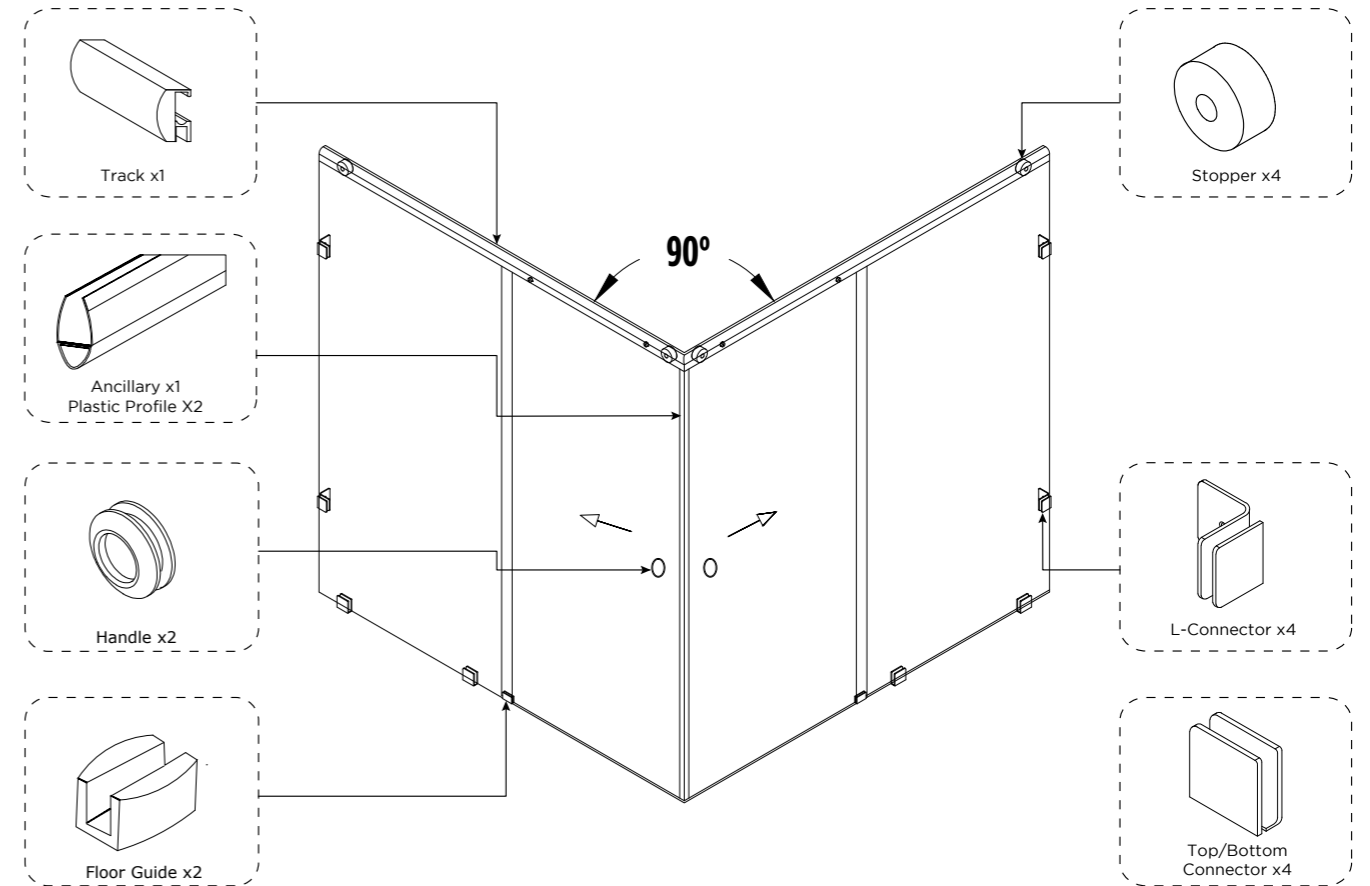

TECHNICAL DATA

Glass Type: Tempered Glass
 Glass Thickness: 8, 10mm
 Max. Door Height: 2100mm
 Max. Door Weight: 40-45kg
 Applications: Sliding Shower Cubicle
 Standard Finishes: CP
 Material: Stainless Steel

S.No.	Description	QTY.
01	Track	1
02	Ancillary	1
03	Plastic Profile	2
04	Handle	2
05	Floor Guide	2
06	Stopper	4
07	L-Connector	4
08	Top/Bottom Connector	4

SLIDING SHOWER SCREEN SYSTEM

OSSL.SYS.1E 2M CP
OSSL.SYS.1E 3M CP
Wall to Wall System



Watch Video



OSSL.SYS.90.1E 1.65mx2 CP
Corner Entry System



Watch Video



- Maximum Door Weight: 50kg
- Maximum Door Width: 750mm
- Maximum Door Height: 2000mm
- Maximum Glass Thickness: 8, 10mm

COMPONENT DETAILS

SLIDING SHOWER SCREEN ACCESSORIES		Wall to Wall System	Corner Entry System
	Ø35 Stainless Steel Knob Clamp Roller Finish: Polished or Satin Stainless Steel *Suits 8-10mm Glass Thickness	2pcs	4pcs
	Aluminium Top Track Finish: Polished or Satin Aluminium	2 meters Length	1.65 - 2 meter Length
	Stainless Steel Mounting Bracket (LH/RH) Finish: Polished or Satin Stainless Steel	1 Set (1 LH and 1 RH)	1 Set (1 LH and 1 RH)
	Nylon End Stopper with Catch Device	2pcs	4pcs
	Single-U Nylon Floor Guide	1pc.	2pcs
	Track Corner Joint Finish: Polished or Satin Chrome (for Corner Entry System)	N.A.	1pc.

OPTIONAL ACCESSORIES



ODK-2 STD PSS
Glass Door Knob



OPS-M3 STD
90° Magnetic Seal



OPS-9 STD
Offset Lip Seal



OZGL-UPR-SS
Stainless Steel Channel
For 10 & 12mm Glass
(Available in 900mm
& 1660mm Length)



OGC-4 STD SSS
Wall-to-Glass
Connector 90°

SLIDING DOOR SYSTEM - OSL-ED-SYS-11:

For Shower Enclosures & Internal Doors



Watch Video

Product Code (Only for Individual Product Order)	Product Image	How to Order (Available in kits only)	
		OSL-ED-SYS-11 1.65 mtr Kit includes Available Finish:	OSL-ED-SYS-11 2 mtr Kit includes Available Finish:
SL-ED-11-A1 STD PSS Sliding Door Roller		02 Sets	02 Sets
SL-ED-11-A2 STD PSS Track to Glass Holder		02 pcs	02 pcs
SL-ED-11-A3 STD PSS Stopper		02 pcs	02 pcs
SL-ED-11-A4 STD PSS Floor Guide		01 pc	01 pc
OSSKH-1-ED STD PSS Wall-to-track Connector		02 pcs	02 pcs
OSSKH-ACC-25T-ED 1.65Mtr PSS OSSKH-ACC-25T-ED 1.65Mtr BM Connector Track		01 pc	-
OSSKH-ACC-25T-ED 2Mtr PSS OSSKH-ACC-25T-ED 2Mtr BM OSSKH-ACC-25T-ED 3Mtr PSS Connector Track <i>(Please note that 2mt Track does not have Pre-drilled Holes for A2)</i> *against on request		-	01 pc

Optional Fitting for 90 Application



SL-ED-11-A6 STD PSS
Track to Glass Holder
Optional for 90 Application