

COMPLETE ARCHITECTURAL HARDWARE & SECURITY SOLUTIONS



Innovation for **total VISION™**

Ozone continues with the concept of 'Total Vision' to create transparent & elegant commercial spaces. Every fitting in our Architectural Glass Hardware range is designed to meet the concept of 'Total Vision.'

Ozone is a young, dynamic company offering Architectural Hardware & Security Solutions through a wide range of standard and customized products. A solution-centric approach has enabled Ozone to grow from a startup to one of the leading brands in the Architectural Hardware Industry. Globally the Company has made its footprint by supplying goods to almost 40+ countries. With a Global Perspective in mind right from its inception, the Company has ensured each product has the quality and certifications so that they can be offered to all work markets.

Manufacturing Capability

Our state-of-the-art Manufacturing Facilities backed by design capability enable us to provide other OEM services in India and Overseas. We can offer Stainless Steel OEM services for manufacturing of Casted, Machine Turning, & Sheet Metal Components in all grades of Stainless Steel and other metals.



AUTOMATED STATE-OF-THE-ART Manufacturing Facility

Our **manufacturing** units are equipped with the latest CNC Machines, Hi-Tech Laser Machines, Water Jet Cutting Machines, and Automatic Polishing and Robotic Welding Machines to deliver consistent finishes. All units have unique operations that work together continuously at maximum efficiency. Each product is checked for quality and perfection, ensuring the highest level of customer satisfaction.



CNC Laser Cutting Machine



Scan QR Code for Manufacturing Facility

Location:
Kala Amb
Himachal Pradesh
India



VMC (Vertical Machine Centre)

Polishing Machine

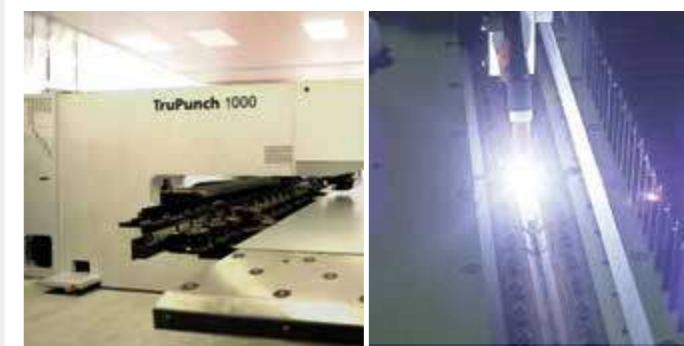

CNC Punching Machine

Welding Centre

Our Product Range

For over two decades, Ozone has offered Architectural Hardware Solutions with a diversified portfolio of more than 5000 products. These products are tested and certified internationally for quality, functionality, and performance.

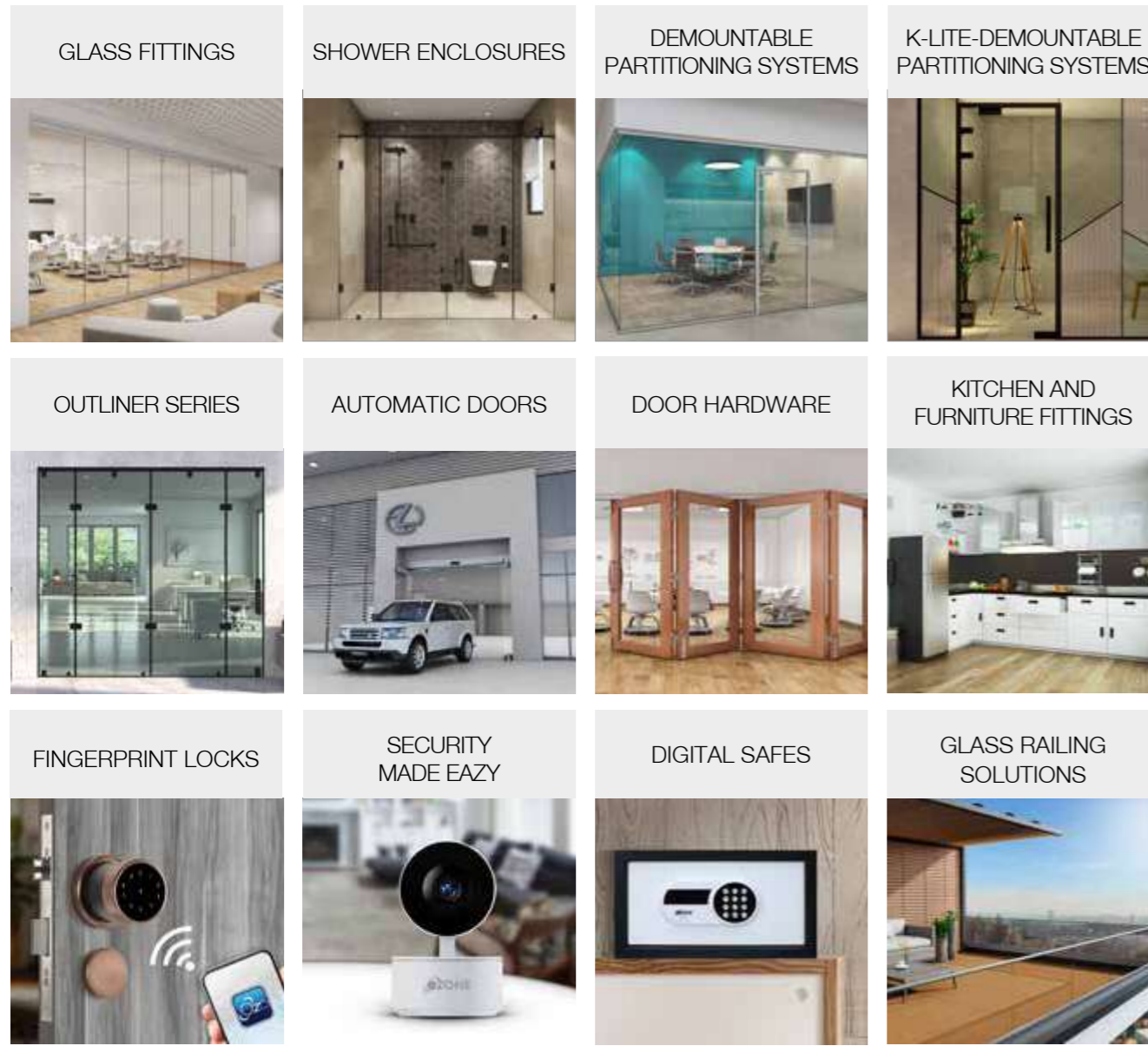

Ozone has partnered with **KUBIK** to create India's most extensive range of Complete Partitioning Solutions for Homes, Offices, Banquets, Schools, and similar establishments. The new entity is named KUBOZ Arc Private Limited.



GLOSSARY

Code Nomenclature for Different Color Finish Products

Product Code	Color	Final Product Code
OPF-1 STD	SSS	OPF-1 STD SSS

	AB Antique Bronze		GP Gold Plated
	ABM Anodized Black Matt		GM-PVD Gold Matt – PVD
	AN Aluminium Anodized		GG-PVD Gold Glossy – PVD
	BG Black Glossy		PSS Polished Stainless Steel
	BG-PVD Black Glossy - PVD		PSS/SSS Polished Stainless Steel/ Satin Stainless Steel
	BM Black Matt		RG Rose Gold
	BM-PVD Black Matt – PVD		RGG-PVD Rose Gold Glossy – PVD
	BMSS Black Matt Stainless Steel		RGM-PVD Rose Gold Matt – PVD
	CP Chrome Polished		SN Satin Nickel
	CS Chrome Silver		SSS Satin Stainless Steel
	WSS Wooden Stainless Steel		WD Wooden

***NOTE:**

- Shades may vary for different products.
- Kindly check for availability, lead time, and MOQ for special finishes.

INDEX...

GLASS FITTINGS **Pg-01-47**

- Patch Fittings & Locks
- The Original Self Closing Patch Fittings
- Hydraulic Door Hinges
- Glass Door Rail
- Central Pivot Hinge
- Pivot Hinges for Swing Glass Door
- Glass Wedge System
- Magnetic Lever Handle & Strike Lock
- Sliding Door System
- Sliding Folding System
- Glass Facade Spider Fittings & Accessories

SHOWER ENCLOSURES **Pg-48-61**

- T Swing Shower Enclosure
- Shower Enclosure Fittings
- Towel Bars with Handle
- Sliding Shower Systems

OUTLINER SERIES **Pg-62-97**

- SW -11/22/33 Swing Door & Profiles
- EN-11/22/33/44/55 Shower Enclosure & Profiles
- Sliding Folding System with Profiles
- Automatic Sliding System with Profiles

DEMOUNTABLE PARTITIONING SYSTEMS **Pg-98-123**

- Hana Eazy - 11/22/33/44/55/66 - Swing Door Systems
- Hana Eazy SL - 11/22/33 - Sliding Door Systems
- Hana Eazy Shower - 11/22 - Framed Shower Enclosures

GLASS RAILING SOLUTIONS **Pg-124-135**

- Stand-off Systems
- Spigot Systems
- Mini Balusters
- Clear Line Railing
- Standard Balusters

AUTOMATIC DOORS **Pg-136-165**

- Automatic Sliding Door Systems & Accessories
- Automatic Swing Door Systems
- Hotel RFID Card Locks & Hotel DND System
- Movable Acoustic Wall Partition Systems

DOOR HARDWARE **Pg-166-205**

- Door Closers
- Floor Spring & Accessories
- Self Closing Patch Fittings
- Door Handles
- Door Locks
- Night Latch Locks
- Panic Door Hardware
- 3D Concealed Hinges & Accessories
- Sliding Door Systems
- Sliding Folding System

KITCHEN AND FURNITURE FITTINGS **Pg-206-259**

- Ergotech Drawer Systems
- Pantry Unit
- Drawer Slides
- Auto-Close Concealed Hinges
- Kitchen Storage Organizers
- Wardrobe Sliding Systems & Accessories
- Bed Fittings
- Fingerprint Furniture Locks
- Height Adjustable Tables
- Wire Baskets

FINGERPRINT LOCKS **Pg-260-269**

- Fingerprint Locks for Wooden & Glass Doors
- Fingerprint Furniture Locks & Accessories

SECURITY MADE EAZY **Pg-270-277**

- Video Door Phones, Wi-Fi Cameras, & Door Bell
- Wi-Fi Smart Plugs

DIGITAL SAFES **Pg-278-289**

- Fire Warrior Safes
- Home & Office Safes
- Hotel Safes
- Manual Safes
- Hazard Safes



GLASS FITTINGS

Ozone offers an extensive collection of Glass Door Hardware to create different door configurations using combination of various fittings & accessories. A wide range of patch fittings is presented here from this collection. Available in different finishes and designs, these patch fittings meet the functional as well as aesthetic need of a space. Every hardware fitting undergoes stringent tests for quality, stability, & safety as per international standards in testing parameters.

STANDARD PATCH FITTINGS

OPF-1 STD SSS
OPF-1 STD PSS
Over Panel Side Panel Connecting Patch with Pivot

OPF-1 STD BM **OPF-1 STD GOLD M-PVD** **OPF-1 STD ROSE GOLD M-PVD**

OPF-2 STD SSS
OPF-2 STD PSS
Top Patch

OPF-2 STD BM **OPF-2 STD GOLD M-PVD** **OPF-2 STD ROSE GOLD M-PVD** **OPF-2 STD ANTIQUE BRONZE**

OPF-3 STD SSS
OPF-3 STD PSS
Bottom Patch

OPF-3 STD BM **OPF-3 STD GOLD M-PVD** **OPF-3 STD ROSE GOLD M-PVD** **OPF-3 STD ANTIQUE BRONZE**

OPF-610 STD SSS
OPF-610 STD PSS
Over Panel Side Panel Connector

OPF-610 STD BM **OPF-610 STD GOLD M-PVD** **OPF-610 STD ROSE GOLD M-PVD** **OPF-610 STD WD**

OPF-640 STD SSS
OPF-640 STD PSS
Wall-to-Glass Clamping Patch

OPF-640 STD BM **OPF-640 STD GOLD M-PVD** **OPF-640 STD ROSE GOLD M-PVD** **OPF-640 STD WD**

OPF-650 STD SSS
OPF-650 STD PSS
Glass-to-Glass Connecting Patch to Wall/Ceiling

OPF-650 STD WD

OFS-ACC-GDP SSS
OFS-ACC-GDP PSS
Top Pivot for Patch/Point Fitting Doors

OFS-ACC-GDP BM **OFS-ACC-GDP GOLD M-PVD** **OFS-ACC-GDP ROSE GOLD M-PVD**

STANDARD PATCH FITTINGS

OPF-640E STD SSS
Wall-to-Glass Clamping Patch

OPF-640E STD BM

E Series

OPF-610 R/L STD SSS
OPF-610 R/L STD PSS
Triple Glass Connector with Fin (Right / Left)

OPF-610 ST STD SSS
OPF-610 ST STD PSS
Over Panel Side Panel Connector with Stopper (One Side Opening Door)

OPF-620 STD SSS
OPF-610 ST STD PSS
Quadruple Connector

OPF-620 F STD SSS
OPF-620 F STD PSS
Quadruple Connector with Fin

OPF-630 F STD SSS
OPF-630 F STD PSS
Double Glass Connector with Fin Fitting Inside

OPF-650 AA STD SSS
OPF-650 AA STD PSS
Wall-to-Glass Clamping Patch

OPF-660 STD SSS
OPF-660 STD PSS
Double Glass Connector To Integrate Two Glasses in the Centre

OPF-41 R/L STD SSS
OPF-41 R/L STD PSS
Over Panel Side Panel Connector with Fin (Right/Left)

OPF-51 STD SSS
OPF-51 STD PSS
Over Panel Connector for Back to Back Doors

STAINLESS STEEL PATCH FITTINGS

Solid Stainless Steel Patch Fittings in SS 304 grade



OSSPF-1 STD SSS
Over Panel Patch With Pivot



OSSPF-2 STD SSS
Top Patch



OSSPF-3 STD SSS
Bottom Patch



OSSPF-4 STD SSS
Wall Mounted Over Panel
Patch with Pivot



OSSPF-GDP STD SSS
Top Pivot For SS Patch Fitting



OSSPF-610 STD SSS
Over Panel Side Panel
Connector



OSSPL-1 STD SSS
Patch Lock



OSSPF-41 L (Left) SSS
Over Panel Side Panel Patch
With Pivot Pin & Fin Attachment



OSSPF-41 R (Right) SSS
Over Panel Side Panel Patch
With Pivot Pin & Fin Attachment



OSSPF-51 SSS
Double Pivot Patch For
Back To Back Door With Fin

PREMIUM PATCH FITTINGS



OPF-1S STD SSS
Over Panel Side Panel
Connecting Patch with Pivot



OPF-2S STD SSS
Top Patch



OPF-3S STD SSS
Bottom Patch



OPF-4S STD SSS
Wall Mounted Over Panel
Patch with Pivot



OPF-610S STD SSS
Over Panel Side Panel
Connector



OPL-1S STD SSS
High Security Patch Lock

Finish : SSS
SS-316 **S Series**
Premium Collection of
Architectural Hardware

PATCH FITTINGS

E Series
Finish : SSS



OPL-1E STD SSS
Corner Patch Lock



OPL-1E STD BM



OPF-2E STD SSS
Top Patch



OPF-2E STD BM



OPF-3E STD SSS
Bottom Patch



OPF-3E STD BM



OFS-ACC-GDP-E SSS
Top Pivot for Patch/Point
Fitting Doors



OFS-ACC-GDP-E BM

GLASS CONNECTORS

Plus Series for Glass Partition

Glass Thickness: 10-12mm



OGC-1+ STD SSS
OGC-1+ STD PSS
Wall-to-Glass Connector



OGC-3+ STD SSS
OGC-3+ STD PSS
Glass-to-Glass Connector 90°



OGC-4+ STD SSS
OGC-4+ STD PSS
Wall-to-Glass Connector 90°



PATCH LOCKS

Finish : PSS, SS & SSS

THE ORIGINAL SELF CLOSING PATCH FITTING

OPL-1 STD SS
OPL-1 STD PSS
Corner Patch Lock with Strike Plate

OPL-1 STD BM OPL-1 STD GOLD M-PVD OPL-1 STD ROSE GOLD M-PVD OPL-1 STD ANTIQUE BRONZE

OPL-3A STD SS
Thumb Turn Lock and Strike Box

OPL-3A STD BM

OPL-3B STD SS
Strike Box for OPL-3A

OPL-3B STD BM

OPL-2A STD SS
Centre Patch Lock

OPL-2B STD SS
Strike Box for OPL-2A

OPL-2A STD BM OPL-2B STD BM

Key Outside & Knob Inside
Glass-to-Glass Application

NO
Glass Cut-out Required

Strike Box Lock

Front Side Back Side

Key Outside & Knob Inside
Glass-to-Wall Application

NO
Glass Cut-out Required

Strike Plate Lock

Front Side Back Side

OPL-4A/4B-K2N STD SSS
Patch Locks (with strike box)
(Without Cut-Out)

OPL-4A/S-K2N STD SSS
Patch Locks (with strike plate)
(Without Cut-Out)

NO
Glass Cut-out Required

OPL-4A-N-S STD SSS
Glass Door Lock with Strike plate
No Cut-out required

NO
Glass Cut-out Required

OPL-4A/4B-N STD SS
Glass Door Lock with Strike Box
NO Cut-Out required

✓ **THE ORIGINAL**

OCFH-100 STD SSS

- Maximum door width: 1000mm
- Suitable door thickness: 8~13mm
- Tested as per: EN1154
- Ideal for Internal Doors
- Ambient temperature: -20°C to +50°C
- Quick and easy installation
- Finish: SSS

- Maximum door width: 1000mm
- Suitable door thickness: 8~13mm
- Tested as per: EN1154
- Ideal for Internal Doors
- Ambient temperature: -20°C to +50°C
- Quick and easy installation
- Finish: SSS



OCFH-100 STD BM OCFH-100 STD GOLD M-PVD OCFH-100 STD ROSE GOLD M-PVD OCFH-100 STD WD

• For External Doors

• Power Adjustable

OCFH-105 STD SSS

- Maximum door width: 1250mm
- Suitable door thickness: 10~15mm
- Tested as per: EN1154
- Ideal for External Doors

OCFH-105 STD BM

- Maximum door width: 1250mm
- Suitable door thickness: 10~15mm
- Tested as per: EN1154
- Ideal for External Doors

OCFH-135 STD SSS

- Maximum door width: 1000mm
- Suitable door thickness: 10~13mm
- Ideal for Internal & External Doors

OCFH-135 STD BM

- Maximum door width: 1000mm
- Suitable door thickness: 10~13mm
- Ideal for Internal & External Doors

OPF-1 PLUS STD SSS
Connects Over Panel and Side Panel with Pivot
(Size of OCFH-100)

OPF-2 PLUS STD SSS
Top Patch
(Cover Size Same as OCFH-100)

OPF-2 PLUS STD BM OPF-2 PLUS STD GOLD M-PVD OPF-2 PLUS STD ROSE GOLD M-PVD OPF-2 PLUS STD WD

THE ORIGINAL SELF CLOSING PATCH FITTING

With Enhanced Finish & Superior Quality



OCFH-100S STD SSS

Features:

- Cover & base plate in high grade Stainless Steel 316
- Corrosion resistant
- 3 years warranty
- Compliant with EN 1154 standard

Specification:

- Quick and easy installation with just 4 fasteners
- EN-3 for interior & exterior applications
- Suitable door weight: Maximum 100kg.
- Suitable door width: 750~1000mm
- Suitable door thickness: 8~12mm
- Maximum opening 150 and controlled 135
- Durability- 500,000 Cycles tested
- Ambient temperature: -20 C to +50 C



OCFH-100S STD
BM



OCFH-100S STD GOLD
M-PVD



OCFH-100S STD ROSE GOLD
M-PVD



TOP PATCH FOR OCFH-100S



OPF-2S PLUS STD SSS

Specifications

- Top Patch
- Variable Pivot Point of 55 to 65mm
- Quick Release Covers
- 1.5mm thick SS 316 cover plate
- Cover plate secured with a snapfit mechanism
- Base casting material: Alloy Steel
- SS316



OPF-2S PLUS STD
BM



OPF-2S PLUS STD GOLD
M-PVD



OPF-2S PLUS STD ROSE GOLD
M-PVD

TOP PIVOT FOR OCFH-100S



OFS-ACC-GDP-S STD SSS

Specifications

- Stainless Steel Pivot
- Wear Resistant Pivot Pin
- Pivot Held in Overhead Structure
- Finish: SSS



OFS-ACC-GDP-S BM



OFS-ACC-GDP-S GOLD
M-PVD



OFS-ACC-GDP-S ROSE GOLD
M-PVD

*T & C Apply

THE ORIGINAL SELF CLOSING PATCH FITTING GLASS DOOR SET



OCFH-100 Set STD SSS

- Set Package Includes:**
- OCFH-100 STD
 - OPF-2 Plus (Top Patch)
 - OFS-ACC-GDP (Pivot)

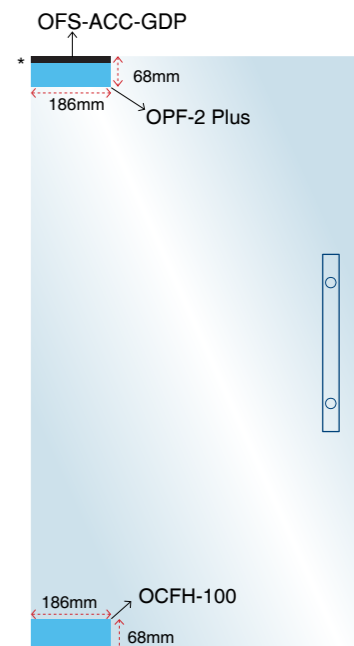

Watch Video



OCFH-100 Set STD
BM



OCFH-70E Set STD SSS

Door weight upto 70kg

- Set Package Includes:**
- OCFH-70E STD SSS
 - OPF-2E (Top Patch)
 - OFS-ACC-GDP-E (Pivot)



Note:-Same Cut-Out as Standard OCFH-100

*Product Dimensions

HYDRAULIC DOOR HINGES

Suitable for Interior Application
High Quality Spring | Smooth & Soft Closing Function | Elegant Design



SS-316
Finish : SSS



- Features:**
- Spring loaded hydraulic hinges
 - 90° hold open and no hold open options available
 - Adjustable opening & closing speed

- Specifications**
- Double action door hinge
 - Suitable for door size: 1000 x 2200mm
 - Maximum glass thickness: 8 - 12mm
 - Maximum door weight: 100 Kg (220Lbs) - Each Pair
 - Maximum closing force: 4-8Nm
 - Opening angle: 90° (Double Action)
 - Material: SS 304



Closing & Latching Speed
Adjustment Valve



OZ-DH-H1 STD SSS
Wall-to-Glass Hydraulic Hinges



OZ-DH-H2 STD SSS
Glass-to-Glass Hydraulic Hinges

PARTITION DOOR HINGES



OGC-DH-SC-1 STD SSS
Wall-to-Glass Hinge 90°
Spring Loaded
(supplied in pair)



OGC-DH-SC-4 STD SSS
Glass-to-Glass Hinge 90°
Spring Loaded
(supplied in pair)

Finish : SSS
SS-304
For 10mm Glass

GLASS DOOR RAIL



Watch Video

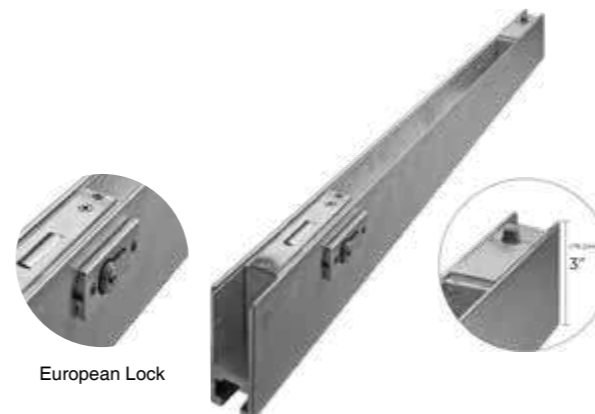

European Lock

ODR-SC-1.2mtr SSS
Door rail with hydraulic system in European Type
Height of Door Rail : 76.2mm (3")
Width of Door Rail : 40mm (1.5")



ODR-SC-1.2mtr ABM

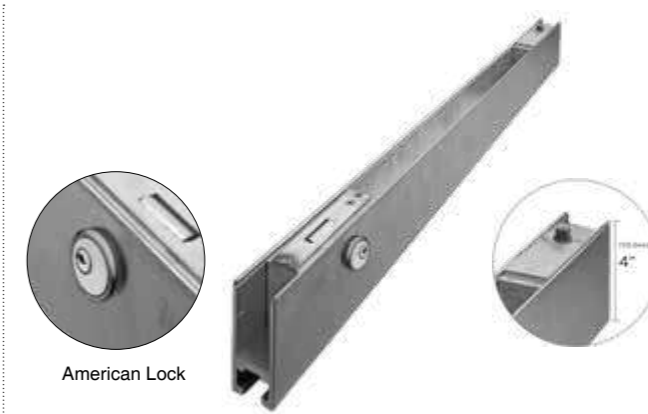

American Lock

***OCDR-AMR-1mtr SSS**
Door rail with hydraulic system in American Type
Height of Door Rail : 101.6mm (4")
Width of Door Rail : 50.8mm (2")



***OCDR-AMR-1mtr ABM**



***ODR-1 1 mtrs SSS**
***ODR-1 1.5 mtrs SSS**
Top rail without hydraulic system



***ODR-2 1 mtrs SSS**
***ODR-2 1.5 mtrs SSS**
Bottom rail without hydraulic system with lock

*Available on request

PIVOT HINGES FOR SWING GLASS DOORS

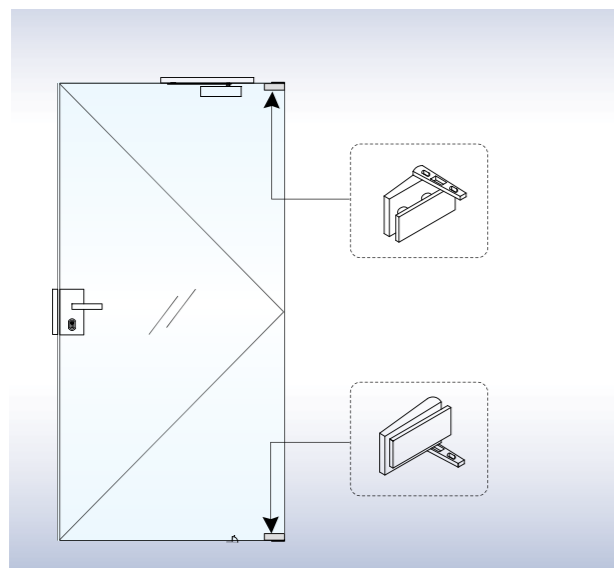

- Features:**
- Easy installation
 - Horizontal adjustment: $\pm 3\text{mm}$
 - Vertical adjustment: 8-16mm
 - Non-handed design

- Specifications:**
- For single/double swing door
 - SS 304 grade material
 - Push open at any position

S Series
Premium Collection of Architectural Hardware
SS-316

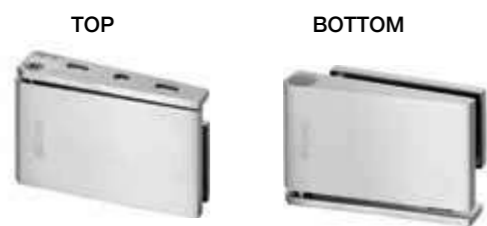

OZ-PGDH STD SSS
Pivot Hinge Set
Finish: SSS

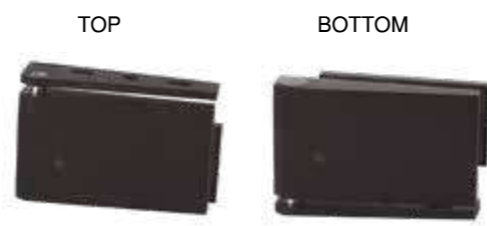

OZ-PGDH STD BM
Pivot Hinge Set
Finish: Black Matt

CENTRAL PIVOT HINGE WITH 360° ROTATION



- Features**
- 360° rotation
 - Free rotate inside or outside
 - Equal opening on both side of axis
 - Hold open at 90°

- Specifications**
- Weight carrying capacity upto 200kg
 - Door width 2500mm
 - Suitable door thickness 10-15mm
 - Angle of opening 360°
 - Closing speed adjustment
 - Latching speed adjustment
 - Hold-Open feature



OCFH-RD-G 200KG SSS

GLASS WEDGE SYSTEM

Wall Connecting Profiles for Fixed Glasses

Finish : SSS & AN



Available in shoe moulding style. OZONE GLASS WEDGE SYSTEM is a dry mount system which provides the installer with a cleaner, simpler method of setting tempered glass panels.

Features:

- Can be attached with ceiling, floor, or wall
- Available in lengths of 2 meter or 3 meter
- Do not require any glass preparation
- End cap for better aesthetics

OGL-PR-11 2 Mtrs SSS*
OGL-PR-11 3 Mtrs SSS*
OGL-PR-11 3 Mtrs AN*
OGL-PR-11 3 Mtrs ABM*
Glass Wedge System

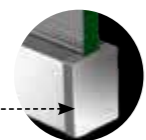

OGL-PR-11-Cap STD STD
End Cap



OGL-PR-11 BM** OGL-PR-11 Gold** OGL-PR-11 Rose Gold**

OGL-PR-22 3 Mtr SSS*
OGL-PR-22 3 Mtr AN*
Glass Wedge System

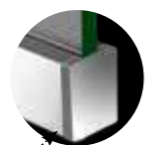

OGL-PR-22-EC STD STD
End Cap



OGL-PR-22 BM

OGL-PR-22E 3 Mtr AN*
OGL-PR-22E 4 Mtr AN*
Glass Wedge System

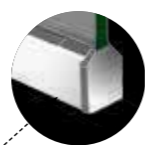

OGL-PR-22-E STD STD
End Cap



OGL-PR-22E BM

New

OGL-PR-44 3 Mtr AN
Tapered Profile

New

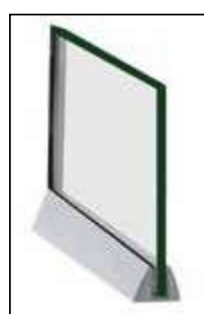

OGL-PR-44 BM

How to order OGL-PR-22?

Kindly order equal length of OZ-EP-DM-44 & the other. EPDM Black as per your glass thickness.

OGL-PR-22 EPDM GASKET				
Product Code	Glass Thickness	Image	Product Code	Image
OZ-EP-DM-11 Black	8 mm		OZ-EP-DM-44 STD Black	
OZ-EP-DM-22 Black	10 mm			
OZ-EP-DM-33 Black	12 mm			

NOTE:*Each profile is accompanied with 2 end caps.
**Maximum 2.5mtr length is available for PVD finishes.

DOOR CLOSERS WITH MOUNTING PLATE FOR GLASS DOORS



NSK-780 STD SILVER
Rack & Pinion Door Closer with Adjustable closing force EN 2-5



NSK-780 STD BM



NSK-980 E STD Light Grey
Overhead Door Closer (Scissors Arm)

- 100Kg Weight Carrying Capacity
- Fire Rated
- CE
- 5 Years WARRANTY
- Tested 500,000 Cycles



NSK-780-TR-HO STD SILVER
Rack & Pinion Door Closer with Hold Open Function and Adjustable closing force EN 2-5

- 100Kg Weight Carrying Capacity
- Fire Rated
- CE
- 5 Years WARRANTY
- Tested 500,000 Cycles
- EN 1154 Tested



NSK-980 SSS
Overhead Door Closer with Hold Open Function and Track Arm

- 80Kg Weight Carrying Capacity
- E Series
- UL
- Tested 500,000 Cycles
- 80 Kg Weight Carrying Capacity



NSK-980 E TA Light Grey
Rack and Pinion Door Closer with Hold Open Function and Adjustable closing force EN 2-4



NSK-980 E TA BM

- 80Kg Weight Carrying Capacity
- UL
- CE
- Tested 500,000 Cycles



NSK-ACC-780 PLATE STD SILVER
Mounting Plate for Glass Door Installation of Door Closer NSK 780



NSK-ACC-780 PLATE STD BM



NSK-ACC-980-PLATE STD SILVER
Mounting Plate for Glass Door Installation of Door Closer NSK 980



NSK-ACC-980 PLATE STD BM



OZ-PGDH STD SSS
Pivot Hinge Set



OZ-PGDH STD BM



OGC-DH-2 STD SSS
Frame Rebate Mounting Hinge (Square)



OGC-DH-2 STD BM

MAGNETIC LEVER HANDLE LOCK FOR FRAMELESS GLASS DOORS

**MAGNETIC STRIKE LOCKS
FOR FRAMELESS GLASS DOORS**

S Series
 Premium Collection of
 Architectural Hardware

SS-316
 Finish : SSS

OZ-MGL-33S Series
 Vertical Glass Door Lock

Optional accessories:



Finish: SSS
 For Product Code, refer table on next page*







OZ-MGL-33S-SB2-L STD SSS
OZ-MGL-33S-SB2-R STD SSS
 Strike Box for Glass-to-Glass Application

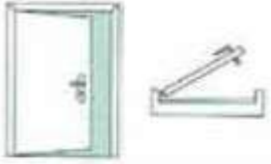
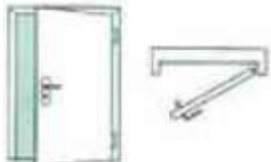
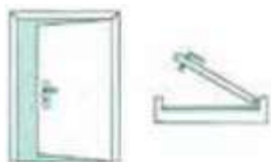
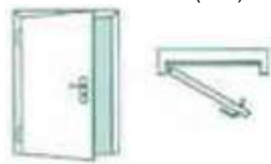

OZ-MGL-33S-SP2 STD SSS
 Strike Plate for Magnetic Rectangular Glass
 Door Lock for Glass-to-Wall Application

MAGNETIC LEVER HANDLE LOCK FOR FRAMELESS GLASS DOORS

*How to order OZ-MGL-33S

Product Code	Description	Pic Reference-DIN Outside View	Compatible Strike Box
OZ-MGL-33S-R-I-K2N SSS	Inward-Key-to-Knob for RH opening	Right Hand inward (DIN) 	OZ-MGL-33S-SB2-R Std SSS
OZ-MGL-33S-R-O-K2N SSS	Outward-Key-to-Knob for RH opening	Right Hand Outward (DIN) 	OZ-MGL-33S-SB2-R Std SSS
OZ-MGL-33S-L-I-K2N SSS	Inward-Key-to-Knob for LH opening	Left Hand inward (DIN) 	OZ-MGL-33S-SB2-L Std SSS
OZ-MGL-33S-L-O-K2N SSS	Outward-Key-to-Knob for LH opening	Left Hand outward (DIN) 	OZ-MGL-33S-SB2-L Std SSS
OZ-MGL-33S-R-I-K2K SSS	Inward-key to key for RH opening	Right Hand inward (DIN) 	OZ-MGL-33S-SB2-R Std SSS
OZ-MGL-33S-R-O-K2K SSS	Outward-key to key for RH opening	Right Hand outward (DIN) 	OZ-MGL-33S-SB2-R Std SSS
OZ-MGL-33S-L-I-K2K STD SSS	Inward-key to key for LH opening	Left Hand inward (DIN) 	OZ-MGL-33S-SB2-L Std SSS
OZ-MGL-33S-L-O-K2K STD SSS	Outward-key to key for LH opening	Left Hand outward (DIN) 	OZ-MGL-33S-SB2-L Std SSS

MAGNETIC STRIKE LOCKS

FOR FRAMELESS GLASS DOORS

OZ-MGL-11S Series

Horizontal Glass Door Lock

For Product Code, refer table next page*



OZ-MGL-11S-BT BM

FOR BATHROOM FRAMELESS GLASS DOORS

OZ-MGL-22S-BT Series

Horizontal Bathroom Glass Door Lock

For Product Code, refer table next page*

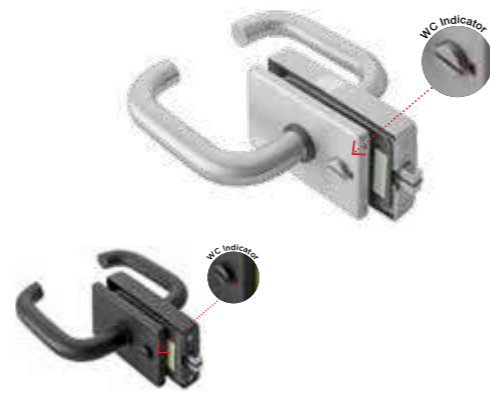

OZ-MGL-22S-BT BM

S Series

Premium Collection of Architectural Hardware

SS-316

Optional accessories for OZ-MGL-11S Series and OZ-MGL-22S-BT Series



OZ-MGL-11/22 S-SB1 STD SSS
Strike Box for Glass-to-Glass Application



OZ-MGL-11/22 S-SP1 STD SSS
Strike Plate for Glass-to-Wall Application



OZ-MGL-11/22 S-SB1 STD BM
Strike Box for Glass-to-Glass Application



OZ-MGL-11/22 S-SP1 STD BM
Strike Plate for Glass-to-Wall Application

*How to order OZ-MGL-22S / OZ-MGL-11S

Product Code	Description	PLC Reference-DIN Outside View	
OZ-MGL-22S-BT-I STD SSS OZ-MGL-22S-BT-I STD BM	Inward-One side knob other side Coin Slot for RH/LH opening	Left Hand Inward (DIN) 	Right Hand Inward (DIN)
OZ-MGL-11S-I-K2N Std SSS OZ-MGL-11S-I-K2N Std BM	Inward-Key-to-Knob for RH/LH opening		
OZ-MGL-22S-BT-O STD SSS OZ-MGL-22S-BT-O STD BM	Outward-One side knob other side Coin Slot for RH/LH opening	Left Hand Outward (DIN) 	Right Hand Outward (DIN)
OZ-MGL-11S-O-K2N Std SSS OZ-MGL-11S-O-K2N Std BM	Outward-Key-to-Knob for RH/LH opening		
OZ-MGL-11S-K2K Std SSS OZ-MGL-11S-K2K Std BM	Universal - key to key opening		

GLASS DOOR HANDLES

Material: Stainless Steel



OGHL-55 35x1500 SSS
Glass Door Handle with locking function

Hole Dia	14mm on attachment point, 22 mm for lock point
----------	--



OGHL-55-25x1340 SSS
Glass Door Handle with locking function

Hole Dia	16mm on attachment point, 35 mm for lock point
----------	--



OGH-661-38x1800 SSS
Glass Door Handle

CTC	1300mm
Hole Dia	12mm



OGH-662-38x1000 SSS
Glass Door Handle

CTC	600mm
Hole Dia	12mm



OGH-663-25x35x600 SSS
Glass Door Handle

CTC	400mm
Hole Dia	12mm



OGH-664-20x40x1200 SSS
Glass Door Handle

CTC	1000mm
Hole Dia	12mm



OGH-551-ED -40x10x400 SSS
OGH-551-ED -40x10x600 SSS
OGH-551-ED -40x20x1200 SSS
Glass Door Handle

CTC	250mm	450mm	900mm
Hole Dia	12mm	12mm	12mm



OGH-552-ED -40x10x450 SSS
OGH-552-ED -40x10x600 SSS
OGH-552-ED-S 40x6x375 SSS
Glass Door Handle

CTC	298mm	450mm
Hole Dia	12mm	12mm



OGH-554-ED -20x40x400 SSS
OGH-554-ED -20x40x800 SSS
Glass Door Handle

CTC	380mm	780mm
Hole Dia	12mm	12mm

GLASS DOOR HANDLES

Material: Stainless Steel



OGH-11		
D Type Handle		
Available in SSS Finish		
Sizes	CTC	Hole Dia
25mm x 325mm	300mm	12mm
25mm x 450mm	425mm	12mm
32mm x 600mm	568mm	12mm



OGH-11 BM



OGH-11 WSS



OGH-11 BMSS

OGH-11		
D Type Handle		
Available in PSS/SSS Finish		
Sizes	CTC	Hole Dia
25mm x 325mm	300mm	12mm
*25mm x 450mm	425mm	12mm
32mm x 600mm	568mm	12mm

S Series
Premium Collection of Architectural Hardware
SS-316



OGH-11S		
D Type Handle		
Available in SSS Finish		
Sizes	CTC	Hole Dia
25mm x 325mm	300mm	12mm
25mm x 450mm	425mm	12mm
32mm x 600mm	568mm	12mm

S Series
Premium Collection of Architectural Hardware
SS-316



OGH-55S		
H Type Handle		
Available in SSS Finish		
Sizes	CTC	Hole Dia
32mm x 457mm	305mm	12mm
32mm x 600mm	480mm	12mm

OGH-55		
H Type Handle		
Available in SSS Finish		
Sizes	CTC	Hole Dia
25mm x 325mm	240mm	12mm
25mm x 350mm	240mm	12mm
25mm x 450mm	308mm	12mm
25mm x 600mm	455mm	12mm
25mm x 1100mm	900mm	12mm
32mm x 457mm	305mm	12mm
32mm x 600mm	480mm	12mm
32mm x 900mm	700mm	12mm



OGH-55 BM



OGH-55 Gold M-PVD

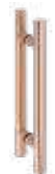

OGH-55 Rose Gold M-PVD



OGH-55		
H Type Handle		
Available in PSS/SSS Finish		
Sizes	CTC	Hole Dia
*25mm x 300mm	212mm	12mm
25mm x 325mm	240mm	12mm
*25mm x 425mm	332mm	12mm
*25mm x 450mm	308mm	12mm
*25mm x 1200mm	1060mm	12mm
25mm x 600mm	455mm	12mm
32mm x 457mm	305mm	12mm
32mm x 600mm	480mm	12mm
*32mm x 1300mm	1100mm	12mm

Grade: SS 202		
OGH-55-E		
E Series		
Sizes	CTC	Hole Dia
19mm x 305mm	212mm	12mm
32mm x 457mm	305mm	12mm

GLASS DOOR HANDLES IN STAINLESS STEEL AND WOOD FINISH COMBINATION

Material: Stainless Steel
Finish : SSS

S Series
Premium Collection of Architectural Hardware
SS-316

- Specifications:**
- Glass hole diameter 12mm
 - Gaskets to prevent the contact between glass and metal
 - Grub screws kept out of sight
 - SS304 grade material

- Features:**
- Wood design aesthetics
 - SSS with wooden finish combination
 - Durable material
 - Design variants available



OGH-11 25x325MM WSS		
Size	CTC	Handle Dia
25mm x 325mm	300mm	25mm



OGH-88 32x480MM WSS		
Size	CTC	Handle Dia
32mm x 480mm	450mm	32mm



OGH-55 32x457MM WSS		
Size	CTC	Handle Dia
32mm x 457mm	305mm	32mm



OGH-11 25x325MM BMSS		
Size	CTC	Handle Dia
25mm x 325mm	300mm	25mm



OGH-88 32x480MM BMSS		
Size	CTC	Handle Dia
32mm x 480mm	450mm	32mm



OGH-55 32x457MM BMSS		
Size	CTC	Handle Dia
32mm x 457mm	305mm	32mm

FLAT GLASS DOOR HANDLE IN DOUBLE TONE



OGH-55F BM/SSS		
Size	CTC	Overall Length
30mm x 325mm	240mm	325mm
30mm x 457mm	305mm	457mm
40mm x 600mm	480mm	600mm

OFFSET PULL HANDLE

SS-304



OGH-OFS-11 BM

OGH-OFS-11 SSS		
Size	CTC	Handle Dia
25mm x 325mm	300mm	25mm
25mm x 475mm	450mm	25mm
25mm x 625mm	600mm	25mm

Available for 8, 10 & 12mm Glass
Standard Length - 2.5m or 8ft

Plastic Profile

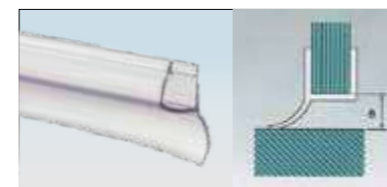

OPS-1 8ft STD
Wall Seal

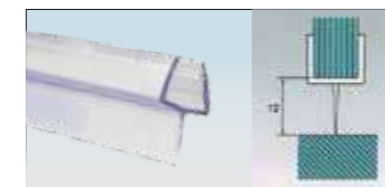

OPS-2 STD
Central Seal

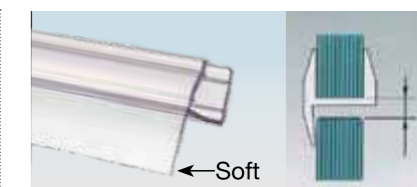

OPS-3 STD (SOFT)
OPS-3 STD BM
***OPS-3-10F 10mm STD**
Central 180° Weather Seal



OPS-4 STD
OPS-4 STD BM
***OPS-4-10F 12mm STD**
Central 180° Weather Seal

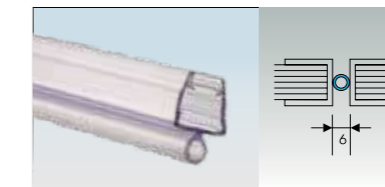

OPS-5 STD
Soft Nose Seal

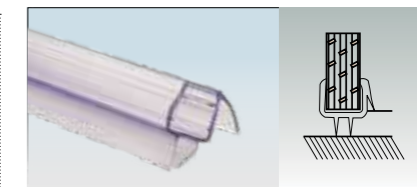

OPS-6 STD
Water Dispersal Seal

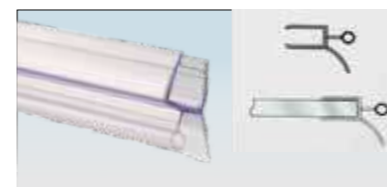

OPS-7 STD
Water Dispersal Seal

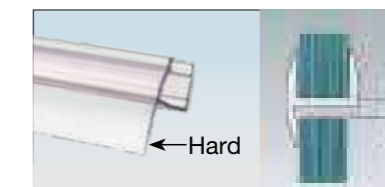

OPS-8 STD (Hard)
OPS-8 STD BM
Central 180° Weather Seal

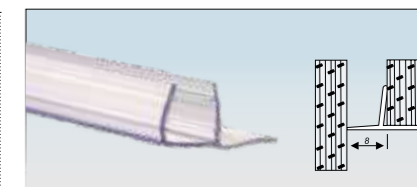

OPS-9 STD
Offset Lip Seal

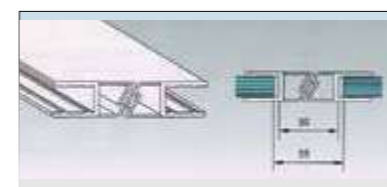

OPS-M1 STD
OPS-M1 STD BM
OPS-M1 STD RG
180° Magnetic Seal

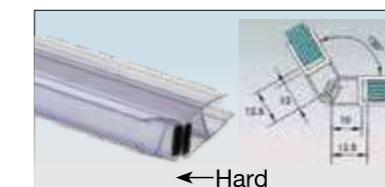

OPS-M2 STD
OPS-M2 STD BM
135° Magnetic Seal

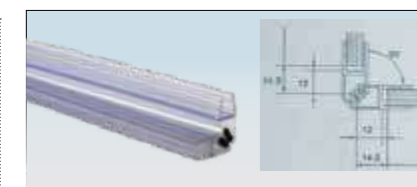

OPS-M3 STD
OPS-M3 STD BM
90° Magnetic Seal

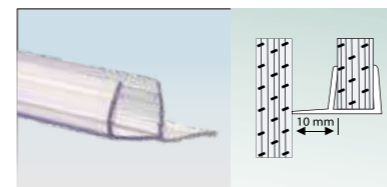

OPS-11 STD
Offset Lip Seal

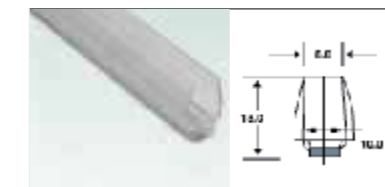

OPS-SL-BR-11 10mm STD
OPS-SL-BR-11 12mm STD
Brush Seal (Central)



OPS-SL-11L 10ft Std
Offset Lip Seal

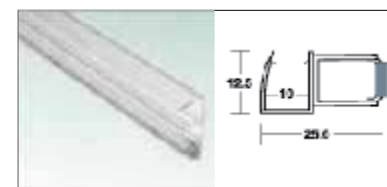

OPS-SL-BR-22-10ft 12m STD
OPS-SL-BR-22N-10ft 12mm
Weather Seal (Sliding Doors)

*Available on request

SLIDING DOOR SYSTEM - 44

Finish : SSS & BM
Glass Thickness: 10-12mm



Product Code	Product Image	OSL-ED-44-A1 KIT STD SSS (Kit Includes) Available Finish: SSS BM	Product Code	Product Image	OSL-ED-44-A2 KIT STD SSS (Kit Includes) Available Finish: SSS BM
OSL-ED-44-A1 STD SSS Roller for Glass Door (60 Kg Wt)		01 Set	*OSL-ED-44-A2 STD SSS Roller for Glass Door (90 Kg Wt)		01 Set
Stopper		02 Pcs	Stopper		02 Pcs
Floor Guide		01 Pc	Floor Guide		01 Pc

ADDITIONAL ACCESSORIES

OZ-SL-44-B1 Track 2mtr STD AN
OZ-SL-44-B1 Track 4mtr STD AN
Aluminium Anodized Track for Sliding Door Panels

OZ-SL-44-B2 Track 2mtr STD AN
OZ-SL-44-B2 Track 4mtr STD AN
Aluminium Anodized Track for Double Sliding Door Panels

OZ-SL-44-B3 Track 2mtr STD AN
OZ-SL-44-B3 Track 3mtr STD AN
OZ-SL-44-B3 Track 4mtr STD AN
Aluminium Anodized Track for Sliding & Fixed Glass Door Panels

OZ-SL-44-B3 Track 2mtr STD BM
OZ-SL-44-B3 Track 4mtr STD BM

OZ-SL-HN-80 STD AN
Sliding Door Handle

OZ-SL-HN-90 STD AN
Sliding Door Handle

SL-HN-20ED SSS
Sliding Door Handle

OZ-SL-HN-80 STD BM

OZ-SL-HN-90 STD BM

SL-HN-20ED STD BM

*Available on request

SLIDING DOOR SYSTEM - 44

Finish : SSS & BM
Glass Thickness: 10-12mm



Product Code	Product Image	SL-44-A1 KIT STD SSS (Kit Includes) Available Finish: BM SSS	Product Code	Product Image	SL-44-A2 KIT STD SSS (Kit Includes) Available Finish: BM SSS
*OZ-SL-44-A1 STD SSS Roller for Glass Door (40 Kg Wt)		01 Set	*OZ-SL-44-A2 STD SSS Roller for Glass Door (80 Kg Wt)		01 Set
OZ-SL-44-A3 STD White Stopper		02 Pcs	OZ-SL-44-A3 STD White Stopper		02 Pcs
OSL-33-G Floor Guide		01 Pc	OSL-33-G Floor Guide		01 Pc

OTHER ACCESSORIES

As per Site requirement

OZ-SL-44-A4 STD STD
Cover Plate for Track B1

OZ-SL-44-A5 STD SSS
Wall-to-track Fixer

OZ-SL-44-A6 STD SSS
Glass-to-track Fixer with Counter Sunk

OZ-SL-44-A7 L/R STD STD
Curved Track Cover End Piece (L/R)

SL-44-A9 STD STD
Wall-to-track connector

SL-44-A8
90 track connector

SL-44-A10 STD SSS
Sliding System Roller for Glass Door

OZ-SL-44-B1 Track 2mtr STD AN
OZ-SL-44-B1 Track 4mtr STD AN
Aluminium Anodized Track for Sliding Door Panels

OZ-SL-44-B2 Track 2mtr STD AN
OZ-SL-44-B2 Track 4mtr STD AN
Aluminium Anodized Track for Double Sliding Door Panels

OZ-SL-44-B3 Track 2mtr STD AN
OZ-SL-44-B3 Track 3mtr STD AN
OZ-SL-44-B3 Track 4mtr STD AN
Aluminium Anodized Track for Sliding & Fixed Glass Door Panels

OZ-SL-44-B3 Track 2mtr STD BM
OZ-SL-44-B3 Track 4mtr STD BM

*Available on request

SLIDING PLUS FIX ANODIZED TRACK

Finish : AN
Glass Thickness: 8-10mm



Specifications:

- Finish: Aluminium Anodized
- Sliding and Fix Track

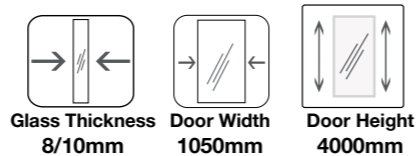

60kg
Weight Carrying Capacity

OZ-ESL-GL-11-60 STD STD
Sliding System Set W/O Track for Single Frameless Door of 60 Kg



OZ-ESL-TRACK-E1F 2mtr AN
OZ-ESL-TRACK-E1F 4mtr AN



80kg
Weight Carrying Capacity

OZ-ESL-GL-11-80 STD STD
Sliding System Set W/O Track for Single Frameless Door of 80 Kg

SLIDING PLUS FIX ANODIZED TRACK

Finish : AN
Glass Thickness: 8-10mm



Specifications:

- Finish: Aluminium Anodized
- Sliding and Fix Track

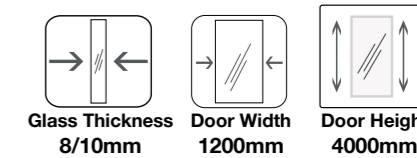

100kg
Weight Carrying Capacity

OZ-ESL-GL-11-100 STD STD
Sliding System Set W/O Track for Single Frameless Door of 100 Kg



OZ-ESL-TRACK-E2F 2mtr AN
OZ-ESL-TRACK-E2F 4mtr AN



150kg
Weight Carrying Capacity

OZ-ESL-GL-11-150 STD STD
Sliding System Set W/O Track for Single Frameless Door of 150 Kg

POCKET SLIDING SYSTEM

Finish : BM
Glass Thickness: 8mm



Construction Image

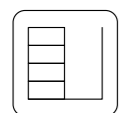

Pocket Construction

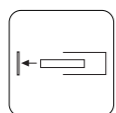

Pocket Sliding

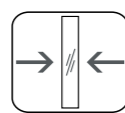

Glass Thickness
8mm

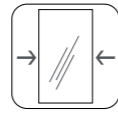

Door Width
1000mm

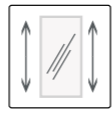

Door Height
3000mm



120Kg
Weight Carrying
Capacity

OZSL-PKT 2000x3000 STD BM*

Key Features:

- Wall pocket solution with the frame structure for the wall
- Softclose opening and closing
- Frame profile door
- Ceiling mounting recessed
- Top running
- Hidden Floor guide

Applications:

- Office
- Living Room
- Kitchen Door
- Lobby Area

* Please Note: other sizes are available on request

PREMIUM MANUAL SLIDING SYSTEMS

Finish : SSS
Glass Thickness: 10-12mm



Item Codes With Soft Close
OZSL-V-S-SYS Std SSS
OZSL-V-S-Track 2mtr SSS

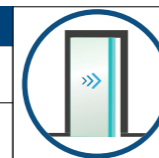

Item Codes Without Soft Close
OZSL-G-S-SYS Std SSS
OZSL-G-S-Track 2mtr SSS



SS-316

Key Features:

- Soft closing single sliding glass door for internal applications
- Elegant and slim design. Can be mounted on glass, wall, and ceiling
- Tested for 100,000 cycles, as per EN1527 standards
- Hydraulic soft closing bumper - Tested for 2,00,000 impact cycles



Specifications:

- Aluminium Anodised top slim Track Size: 54x58mm
- Maximum door weight: 40-80kgs/ 2 carriages
- Maximum Glass Thickness: 10mm or 12mm
- Finish: SSS or brushed clear
- Length: 2mtr (Standard) and 4mtr (Against order)



Optional Fittings:

- Glass Clamp-OZ-GV-A6 for mounting track on glass (06 pcs set)
- Side profile OZ-SL-ST for side fixed panel



OZ-SL-ST 1.3mtr SSS

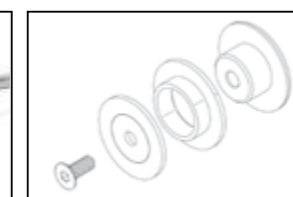

OZ-GV-A6 STD SSS
(06 pcs set)

Note: Heavy duty 80-150 kgs. also available

TELESCOPIC GLASS SLIDING SYSTEMS

Finish : SSS & AN
Glass Thickness: 10-12mm



Ozone introduces the Glass Synchronized Manual Telescopic Sliding Door System to achieve Maximum clear door opening space. Its door panels can be stacked on one side in-line with top track and require minimum parking space.

Its ideal applications are in residential and commercial interior spaces as internal partitioning system. For more details, send an enquiry at support@ozone-india.com

Specifications:

- Maximum Width of Panels - 1000mm
- Maximum Weight of Panels - 90Kg
- Maximum Thickness of Glass - 10/12mm
- Available Track length - 3mtr & 4mtr
- Finish: Aluminum Anodized



Watch Video



3 PANEL DOOR SLIDING SET:

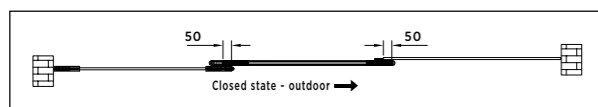

OSL-TG-03 R Std AN
Right Hand Opening

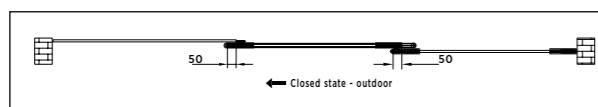

OSL-TG-03 L Std AN
Left Hand Opening

4 PANEL DOOR SLIDING SET:

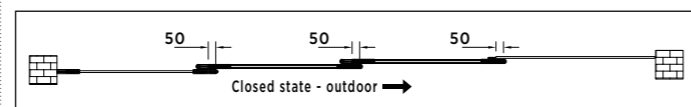

OSL-TG-04 R Std AN
Right Hand Opening

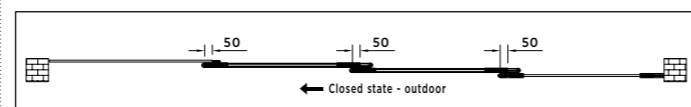

OSL-TG-04 L Std AN
Left Hand Opening

TOP TRACK & ACCESSORIES

Top Track & Accessories For 3 Panels (OSL-TG-3R/3L)

OSL-TG-Track-ACC-3mtr AN 3mtr Track with other Accessories	OSL-TG-Track-ACC-4mtr AN 4mtr Track with other Accessories
--	--



Top Track & Accessories For 4 Panels (OSL-TG-4R/4L)

OSL-TG-Track-ACC-3mtr AN 3mtr Track with other Accessories	OSL-TG-Track-ACC-4mtr AN 4mtr Track with other Accessories
--	--



Additional Accessories Required For 4 Panels

OSL-TGW-Track-3mtr AN for 3mtr

(Bottom U channel 1pc)

OR

OSL-TGW-Track-4mtr AN for 4mtr

(Bottom U channel 1pc)



Bottom U Channel

OSL-TGW-Rope-2mtr SS

(SS Rope 2.3 mtr 1pc)



SS Rope, 2.3mtr



SLIDING SYSTEM FOR FRAMELESS GLASS DOORS

Finish : SSS & AN
Glass Thickness: 8-10mm



E Series



OZ-ESL-GL-11-60 STD STD
Sliding System Set W/O Track for Single Frameless Door of 60 Kg



OZ-ESL-GL-11-80 STD STD
Sliding System Set W/O Track for Single Frameless Door of 80 Kg



OZ-ESL-GL-11-100 STD STD
Sliding System Set W/O Track for Single Frameless Door of 100 Kg



OZ-ESL-GL-11-150 STD STD
Sliding System Set W/O Track for Single Frameless Door of 150 Kg



OZ-ESL-TRACK-E1 2mtr STD
OZ-ESL-TRACK-E1 4mtr STD
Top Track Suitable for ESL GL-11-60 & 80 (Available in 2mtr & 4mtr)



OZ-ESL-TRACK-E2 2mtr STD
OZ-ESL-TRACK-E2 4mtr STD
Top Track Suitable for ESL GL-11-120 & 200 (Available in 2mtr & 4mtr)

CENTER GLASS SLIDING FOLDING SYSTEM WITHOUT BOTTOM TRACK

Finish: SSS
Glass Thickness: 10-12mm



Specifications:

- Sliding panel secured with integrated drop bolt
- End panel secured with bottom lock with key mechanism
- Central stacking that occupy min space in passage or lobby
- Two systems can be installed at both end to give wider opening passage
- System can be installed in various configurations
- Material SS 304 grade
- Finish satin stainless steel

Features:

- Nylon wheels with integrated bearings for quiet & smooth running
- Panel height adjustable with roller
- Panels are connected with hinge
- Cover plate of hardware secured with grub screw

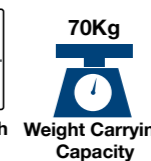

Applications:

- Interior & Exterior application in :
- Commercial Buildings, Residences, Hotels, And Offices

Fittings can be selected based on number of panels :



Folding Door Roller
SL-444-B10



Glass-to-Glass Hinges
SL-444-B6



Upper Fixing Clip
SL-444-B16



Lower Fixing Clip
SL-444-B17



Top Track, Aluminium Finish
SL-444-TT 3mtr An
SL-444-TT 4mtr An



Corner Patch Lock
SL-444-B-CL



Glass Door Bolt
SL-444-B-DB



Bolt Sleeve
SL-444-B-SLV



Strike Plate
SL-444-B-SP

SLIDING DOOR SYSTEM - 444

Finish : SSS
Glass Thickness: 10-12mm

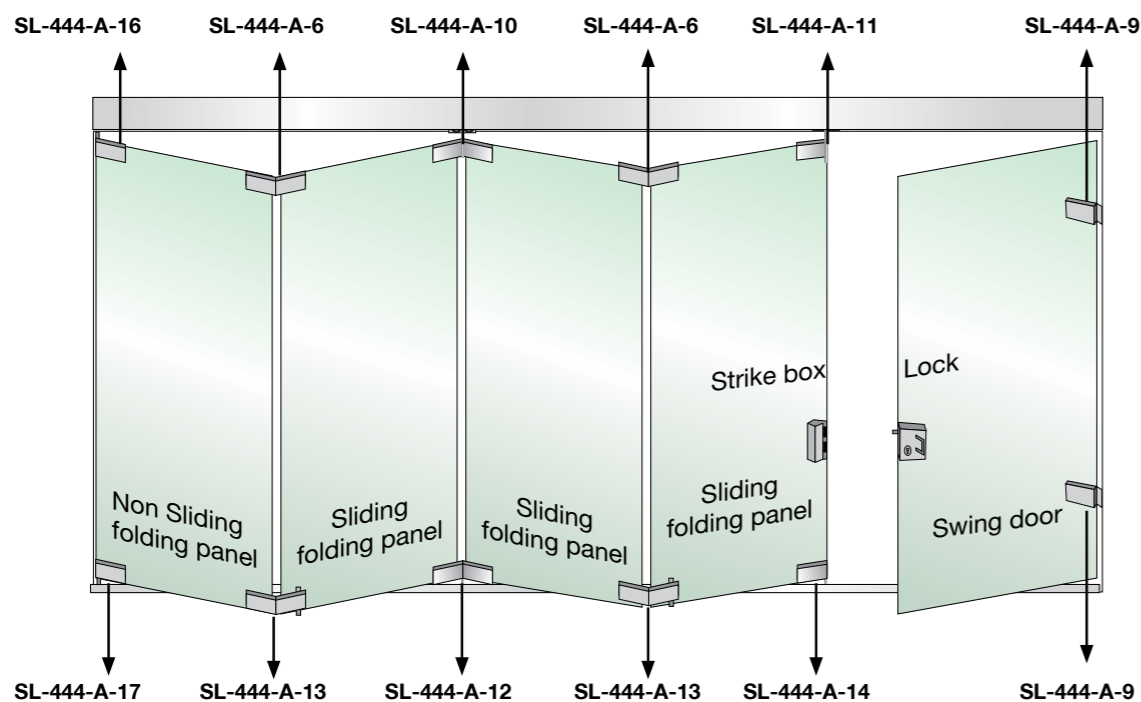

Plan View

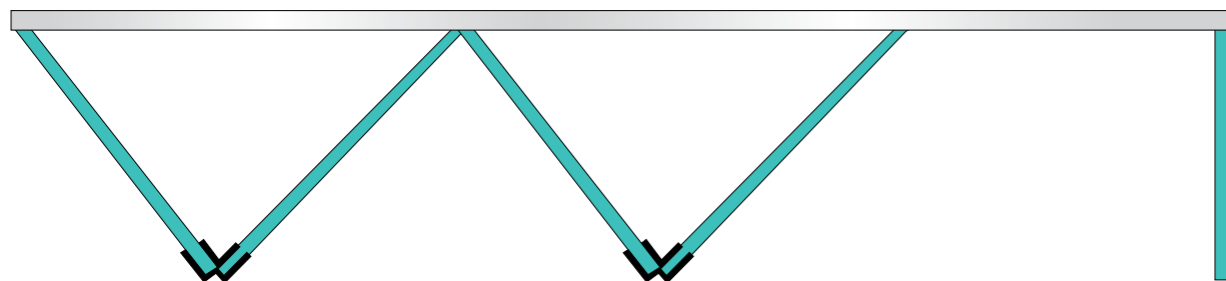

SL-444-TT 3mtr AN
SL-444-TT 4mtr AN
Top Track



SL-444-BT 3mtr SSS
SL-444-BT 4mtr SSS
Bottom Track



SL-444-TT-C 3mtr SSS
SS Cover for Track SL-444-TT



SL-444-A6 STD SSS
Glass-to-Glass
Interconnecting Hinge



SL-444-A10 STD SSS
Glass-to-Glass
Connector With Roller



SL-444-A11 STD SSS
End Sliding Folding Panel
Fitting with Roller



SL-444-A12 STD SSS
Glass-to-Glass Connecting
Hinge with Guide Locator



SL-444-A13-L/R STD SSS
Glass-to-Glass Connecting
Hinge with Floor Lock

SLIDING DOOR SYSTEM - 444

Finish : SSS
Glass Thickness: 10-12mm



SL-444-A9 STD SSS
Glass-to-Wall Hinge
for Single Action Doors



SL-444-A14 STD SSS
End Sliding Folding Panel
Fitting with Guide Locator



SL-444-A16 STD SSS
End Panel Fitting with
Top Pivot



SL-444-A17 STD SSS
End Panel Fitting with
Bottom Pivot



SL-444-A18-L STD SSS
End Panel Fitting with
Bottom Pivot (for odd panels)



SL-444-A18-R STD SSS
End Panel Fitting with
Bottom Pivot (for odd panels)



SDL-14A STD SS
Sliding Door Lock with Knob



SDL-14B STD SS
Sliding Door Strike Box with Knob



Note: Internal Application for Office and Home Partitions

GLASS PARTITION SYSTEM W

Finish : SSS
Glass Thickness: 10-12mm
Maximum Feasible Height: 3mtr



Top View

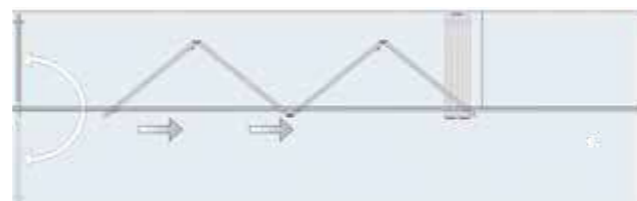

GLASS PARTITION SYSTEM Z

Finish : SSS
Glass Thickness: 10-12mm
Maximum Feasible Height: 3mtr



Top View

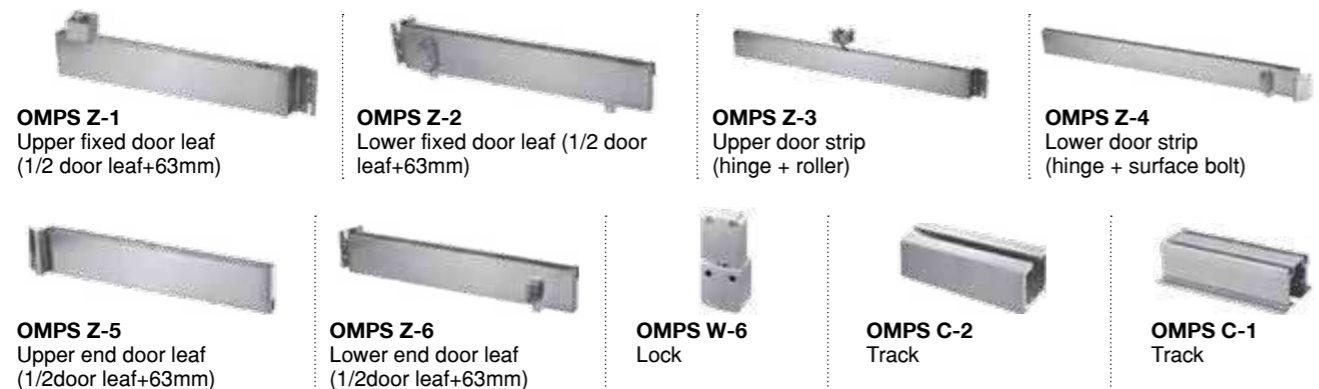
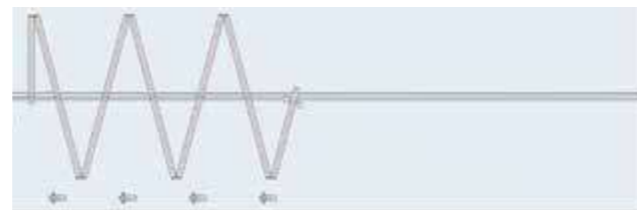

Product Code and Prices available as per Project requirement

GLASS PARTITION SYSTEM B

Finish : SSS
Glass Thickness: 10-12mm
Maximum Feasible Height: 3mtr



Watch Video

Plan View



Product Code and Prices available as per Project requirement

SLIDING GLASS DOOR LOCK WITH HANDLE FOR CONVENIENT ACCESS

Glass Thickness: 08-12mm



Specifications:

- Sliding glass door lock with handle
- Overall dimensions - 170(L) X 70(H) mm
- Lock with European cylinder
- Material - stainless steel
- Finish - brushed nickel plated



SS-316

Features:

- Interchangeable for right & left hand
- Prevents direct contact of glass edge to the wall
- Door can be locked if fixed glass & sliding door panels are on inline*
- Lock can be adjusted for variable gap between fixed glass and sliding door with the help of the spacer**

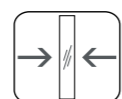

Glass Thickness 08-12mm

Sliding Glass Door Lock:



OSDL-11L-K2N Std SSS
Key-to-Knob for door opening to left
OSDL-11R-K2N Std SSS
Key-to-Knob for door opening to right



OSDL-11-K2K Std SSS
Both side key option for universal door opening

Accessories:

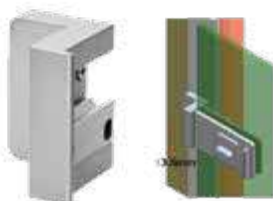

OSDL-11-SB1 STD SSS
Strike Box for Offset Wall/ Frame to Glass

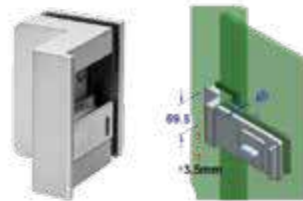

OSDL-11-SB2 STD SSS
Strike Box for Offset Glass to Glass Application



OSDL-11ACC-SPC 5mm SSS**
OSDL-11ACC-SPC 10mm SSS
5/10mm Spacer for Strike Box

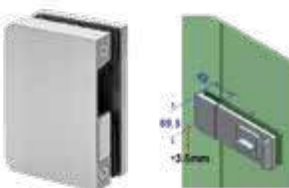

OSDL-11-SB STD SSS*
Strike Box for Inline Glass to Glass Application



OSDL-11ACC-SP STD SSS
Strike Plate

SLIDING DOOR HANDLES FOR FRAMELESS GLASS DOORS

Glass Thickness: 08-10mm



Front



Back

OZ-SL-HN-70 Std SSS
Sliding Door Handle

Specifications:

- Base material aluminium
- BRUSHED stainless steel finish

Features:

- Easy installation
- Easy access from inside & outside
- Increased opening space
- Universal

SLIDING DOOR HANDLES FOR GLASS DOORS



SL-HN-60 STD SSS
Sliding Door Handle



Glass Thickness 08-10mm



OZ-SL-HN-40R STD SSS
Sliding Door Handle



*Available on request

SL-HN-50 STD SSS
***SL-HN-50 STD PSS**
Sliding Door Handle

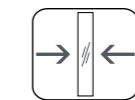

Glass Thickness 08-10mm



SL-HN-50 STD BM



SL-HN-50 STD GOLD G-PVD



SL-HN-50 STD ROSE GOLD G-PVD

SLIDING DOOR HANDLES FOR GLASS DOORS



SL-HN-20ED SSS
Sliding Door Handle



SL-HN-20ED STD BM



***OZ-SL-HN-30 STD SSS**
Sliding Door Handle



OZ-SL-HN-40 STD SSS
Sliding Door Handle



OZ-SL-HN-80 STD AN
Sliding Door Handle



OZ-SL-HN-80 STD BM

*Available on request



OZ-SL-HN-90 STD AN
Sliding Door Handle



OZ-SL-HN-80 STD BM



SLIDING GLASS DOOR HANDLES & LOCK



***SDL-13C STD SSS**
Strike Plate for SDaL-13-A



***SDL-12C Standard SSS**
Strike Plate for SDL-12-B



***SDL-13A STD SSS**
Door Lock with Recessed Handle for Sliding Door



***SDL-12A Standard SSS**
Strike Box with Handle for SDL-12-B



***SDL-12B Standard SSS**
Door Lock with Handle for Sliding Folding Door



***SDL-13B Standard SSS**
Strike Box with Recessed Handle

*Available on request

TWISTED SPIDER FITTINGS WITH FIN

SS-316
Finish: PSS

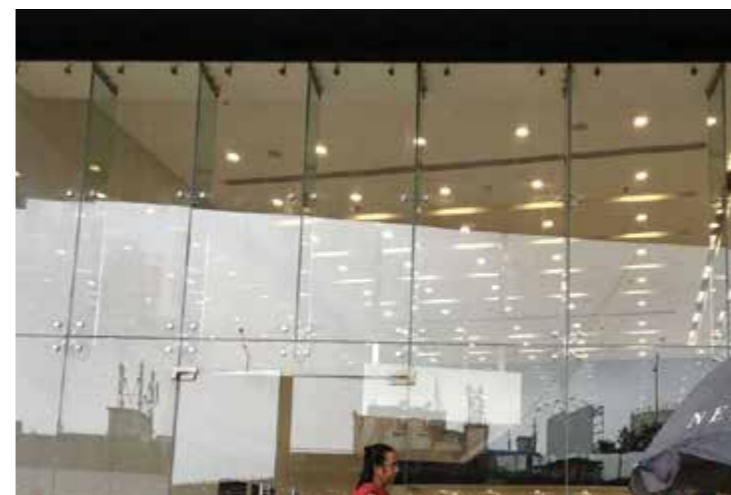

Key Features:

- Curvilinear design reduces stress concentration at transition points
- Twisted arm design gives higher strength
- No dome nut visible on fin side glass
- Compatible with all Ozone routels
- CTC 200mm



OSP-T-4D STD PSS
4 Way Spider with Fin



OSP-T-2D STD PSS
2 Way Spider with Fin



OSP-T-44D STD PSS
2 Way Spider for Ceiling/ Wall



OSP-T-22D STD PSS
1 Way Spider for Ceiling/ Wall

FACADE SPIDER FITTINGS WITHOUT FIN

SS-316
Finish: PSS



Key Features:

- Sleek casted arm design for higher strength
- Tapered arm design provide lateral stiffness against wind-load
- Compatible with all existing Ozone routels
- CTC 200mm



OSP-B-204 STD PSS
4 Way Spider



OSP-B-202 STD PSS
2 Way Spider (180°)



OSP-B-202A STD PSS
2 Way Spider (90°)



OSP-B-201 STD PSS
1 Way Spider

GLASS CLAMP GLAZING SYSTEM (Rhombus Spider)

SS-316

Finish: PSS & SSS (on order)
Tested as per International Standard

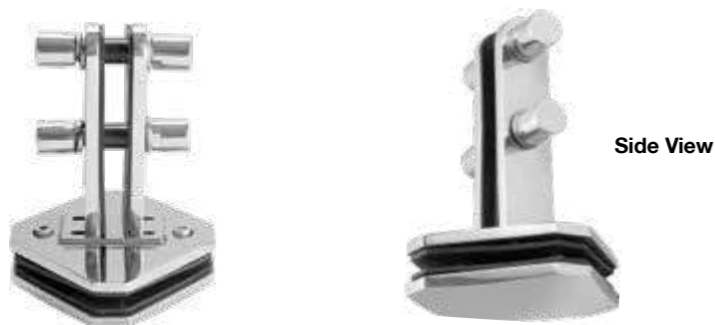

OSP-RB-F4K PSS
Two/Four Way Spider with Fin

SPIDER FITTINGS WITH FIN (Standard Series - 200mm Arm Distance)

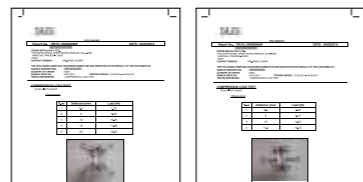

SS-316
Finish: PSS & SSS



OSP-A2 STD SSS
OSP-A2 STD PSS
2 Way Spider with Fin



OSP-A4 STD SSS
OSP-A4 STD PSS
4 Way Spider with Fin



OSP-A22 STD SSS
OSP-A22 STD PSS
1 Way Spider for Ceiling/ Wall



OSP-A44 STD SSS
OSP-A44 STD PSS
2 Way Spider for Ceiling/ Wall

SPIDER FITTINGS WITHOUT FIN (Standard Series - 220mm Arm Distance)

SS-316
Finish: PSS & SSS



OSP-B-221 STD SSS
OSP-B-221 STD PSS
1 Way Spider without Fin



OSP-B-222 STD SSS
OSP-B-222 STD PSS
2 Way Spider without Fin 180



OSP-B-222A STD SSS
OSP-B-222A STD PSS
2 Way Spider without Fin 90



OSP-B-223 STD SSS
3 Way Spider without Fin



OSP-B-224 STD SSS
OSP-B-224 STD PSS
4 Way Spider without Fin



OSP-B-224-90 STD SSS
OSP-B-224-90 STD PSS
4 Way Spider 90 without Fin

SPIDER FITTINGS WITH FIN (200mm Arm Distance)

Finish: SSS



OSP-A2-304 STD SSS
2 Way Spider with Fin



OSP-A4-304 STD SSS
4 Way Spider with Fin

FIN PLATES

(Also Available in 450mm, 500mm & 600mm)
Finish: PSS & SSS



OSP-FP-150 SSS
Fin Plate 150mm



OSP-FP-300 SSS
OSP-FP-300 PSS
Fin Plate 300mm



OSP-FP-350 SSS
OSP-FP-350 PSS
Fin Plate 350mm



OSP-FP-400 SSS
OSP-FP-400 PSS
Fin Plate 400mm

SPLICE PLATES

Finish: SSS & PSS



OSP-SP-170
Splice Plate 170mm



OSP-SP-300 SSS
OSP-SP-300 PSS
Splice Plate 300mm



OSP-SP-350 SSS
OSP-SP-350 PSS
Splice Plate 350mm



OSP-SP-VS-400 Std PSS
Splice Plate for Holding Two Fins



***OSP-SP-250 SSS**
To Hold Two Pieces of Fin Together



***OSP-SP-400 SSS**
Splice Plate 400mm



***OSP-SP-500 SSS**
Splice Plate 500mm

*Available on request

SPIDER FITTINGS WITH FIN (200mm Arm Distance)

E Series SS-316
Finish: PSS

Product Dimension & Glass Cut-Out details are same as of standard series 'OSP-A'



OSP-A2-316E STD SSS
4 Way Spider with Fin



OSP-A4-316E STD SSS
4 Way Spider with Fin



OSP-A22-316E STD SSS
1 Way Spider for Ceiling/ Wall



OSP-A44-316E STD SSS
2 Way Spider for Ceiling/ Wall

SPIDER FITTINGS WITHOUT FIN (220mm Arm Distance)

E Series SS-316
Finish: PSS

Product Dimension & Glass Cut-Out details are same as of standard series 'OSP-B'



OSP-B-221-316E STD SSS
1 Way Spider without Fin



OSP-B-222-316E STD SSS
2 Way Spider without Fin 180°



OSP-B-222A-316E STD SSS
2 Way Spider without Fin 90°



OSP-B-223-316E STD SSS
3 Way Spider without Fin



OSP-B-224-316E STD SSS
4 Way Spider without Fin

ROUTELS

SS-316
Finish: SSS & PSS



OSP-FB-FL STD SSS
OSP-FB-FL STD PSS
Fixed Bolt (Flat Head)
Finish: SSS / PSS



OSP-FB-CS STD SSS
OSP-FB-CS STD PSS
Fixed Bolt (Counter Sunk Head)
Finish: SSS / PSS



OSP-AFB-36-CS STD SSS
Articulate Bolt (Counter Sunk Head)
Finish: SSS / PSS



OSP-AFB-36-FL STD SSS
OSP-AFB-36-FL STD PSS
Articulate Bolt (Flat head)
Finish: SSS / PSS



OSP-AFB-36FL-DGU
Articulated routil for DGU,
for holding inner glass only
Finish: SSS / PSS



OSP-B-AR-12(8+12+12)
Aluminium Ring for Insulated Glass
Finish: Aluminium



OSP-SH-01 Std. SS
To Hold Without Fin
Spiders to Structure



OSP-AFB-36-FL 304
Articulate Bolt (Flat head)
Finish: SSS



OSP-FB-FL 304
Fixed Bolt (Flat Head)
Finish: SSS

E Series

FRAMELESS GLASS CANOPY SYSTEMS

Finish: SSS

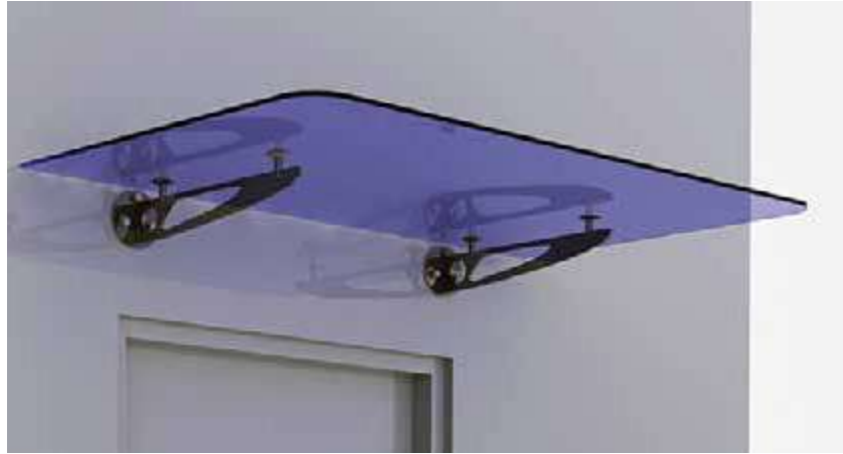

- OCF-22-TR**
Trio shaped Wall mounted Canopy Fitting with Glass on Top.
- Stainless Steel 304 Grade
 - Maximum Glass Size (using 2 fittings) 1800mm* 1100mm
 - Supplied in Pair W/O Glass (Glass available on request)



OCF-01 STD SSS
***OCF-01 STD PSS**
Wall-to-Glass Connector
Finish: SSS



OCF-02 STD SSS
Adjustable Glass Connector for OCF-316
Finish: SSS



OCF-03 STD SSS
***OCF-03 STD PSS**
Wall Fitting for OCF 316
Finish: SSS



OCF-316 STD SSS
Threaded Sleeve for OCF-ROD
Supplied In Pairs
Finish: SSS



OCF-ROD-16mm SSS
***OCF-ROD-16mm PSS**
***OCF-ROD-12mm SSS**
***OCF-ROD-12mm PSS**
for OCF-316
Finish: SSS

PREMIUM FRAMELESS GLASS CANOPY SYSTEMS

Finish: SSS



***OCF-02-S STD SSS**
Glass Fitting for OCF-ROD-S

*Available on request



***OCF-03-S STD SSS**
Wall Fitting for OCF 316



'T' SWING SHOWER ENCLOSURE



OSSH-22T-ED PSS
Double Action 3-Way 'T'
Shower Hinges

Specification:

- Maximum Glass Thickness: 8 & 10mm
- Maximum door width: 700mm
- Opening: inward (recommended) and outward
- Self-closing function activates once door reaches 30°
- SS 304 grade material
- Finish: PSS



Watch Video



OSSH-22T-ED BM



SHOWER HINGES FOR 6/8MM GLASS



OSSH-1-ED 6/8mm PSS
Wall-to-Glass Hinge



OSSH-2-ED 6/8mm PSS
Glass-to-Glass Hinge 180°

Specification:

- Suitable for 6/8mm glass
- Ideal for residential showers & retail displays
- SS-304 grade material
- PSS finish



OSSH-3-ED 6/8mm PSS
Glass-to-Glass Hinge 135°



OSSH-4-ED 6/8mm PSS
Glass-to-Glass Hinge 90°



OSSH-5-ED 6/8mm PSS
Wall-to-Glass Bracket (Fixed Glass)



Suitable for
6/8mm glass

SHOWER HINGES



BRASS
Material

Finish: CP, SN, SSS & PSS



OSH-1 STD CP
OSH-1 STD SN
Wall-to-Glass Hinge for
8-10mm Glass



OSH-2 STD CP
OSH-2 STD SN
Glass-to-Glass Hinge 180°
for 8-10mm Glass



OSH-3 STD CP
OSH-3 STD SN
Glass-to-Glass Hinge 135°
for 8-10mm Glass



OSH-4 STD CP
OSH-4 STD SN
Glass-to-Glass Hinge 90°
for 8-10mm Glass



OSH-5 STD CP
OSH-5 STD SN
Wall-to-Glass Bracket
for 8-10mm Glass



OSH-OFS-1 STD CP
OSH-OFS-1 STD SN
Wall-to-Glass Offset Hinge
for 8-10mm Glass



OSH-66 CP
OSH-66 SN
Wall-to-Glass Hinge for
6-8mm Glass



OSH-77 CP
OSH-77 SN
Glass-to-Glass Hinge for 6-8mm Glass
(Single Side Opening)



***OSH-6 N.A. CP**
Shower Hinge Glass-to-Glass



***OSH-55 STD CP**
OSH-55 STD SN
Wall-to-Glass Bracket
(for Fixed Glass)



***OSH-44 STD CP**
For Connecting a Glass Door with a
Fixed Glass at 90°



***OSH-7 STD CP**
Ceiling/Floor to Glass Pivot
Hinge



***OSH-OFS-11 STD CP**
***OSH-OFS-11 STD SN**
Glass Door Offset Hinge
Connected To Wall

*Available on request

POINT FIXED SHOWER HINGES



*OPSH-11 STD PSS
Wall-to-Glass Hinge



*OPSH-22 STD PSS
Glass-to-Glass Hinge 180°



*OPSH-55 STD PSS
Wall-to-Glass Bracket
(for fixed glass)

GLASS CONNECTORS



OGC-1A STD SSS
OGC-1A STD PSS
Floor/Wall-to-Glass
Connector
for 8-10mm Glass



OGC-2A STD SSS
OGC-2A STD PSS
Glass-to-Glass
Connector 135°
for 8-10mm Glass



OGC-3A STD SSS
OGC-3A STD PSS
Glass-to-Glass
Connector 90°
for 8-10mm Glass



OGC-4A STD SSS
OGC-4A STD PSS
Wall-to-Glass
Connector 90°
for 8-10mm Glass



OGC-5A STD SSS
OGC-5A STD PSS
Glass-to-Glass
Connector 180°
for 8-10mm Glass



SHOWER HINGES

Finish : PSS & SSS
Glass Thickness: 8-10mm **Edge Series**



OSSH-11-ED STD SSS
OSSH-11-ED STD PSS
Wall-to-Glass Hinge



OSSH-11-ED STD
BM



OSSH-11-ED STD
GOLD G-PVD



OSSH-11-ED STD
ROSE GOLD G-PVD



OSSH-22-ED STD SSS
OSSH-22-ED STD PSS
Glass-to-Glass Hinge 180°



OSSH-22-ED STD
BM



OSSH-22-ED STD
GOLD G-PVD



OSSH-22-ED STD
ROSE GOLD G-PVD



OSSH-33-ED STD SSS
OSSH-33-ED STD PSS
Glass-to-Glass Hinge 135°



OSSH-33-ED STD
BM



OSSH-33-ED STD
GOLD G-PVD



OSSH-33-ED STD
ROSE GOLD G-PVD



OSSH-44-ED STD SSS
OSSH-44-ED STD PSS
Glass-to-Glass Hinge 90°



OSSH-44-ED STD
BM



OSSH-44-ED STD
GOLD G-PVD



OSSH-44-ED STD
ROSE GOLD G-PVD



OSSH-55-ED STD SSS
OSSH-55-ED STD PSS
Wall-to-Glass Bracket (Fixed Glass)



OSSH-55-ED STD
BM



OSSH-55-ED STD
GOLD G-PVD



OSSH-55-ED STD
ROSE GOLD G-PVD



OSSH-OFS-11-ED STD SSS
OSSH-OFS-11-ED STD PSS
Off Set Mounted Side Hinge



OSSH-OFS-11-ED STD
BM



OSSH-OFS-11-ED STD
ROSE GOLD G-PVD

*Available on request
Glass Thickness: 8-10mm



OGC-1 STD SSS
OGC-1 STD PSS
Glass Connector for
Wall / Floor Mounting



**OGC-1 STD
BM**



**OGC-1 STD
GOLD G-PVD**



**OGC-1 STD
ROSE GOLD G-PVD**



Glass Thickness: 8-10mm

OGC-2 STD SSS
OGC-2 STD PSS
Glass-to-Glass
Connector 135°

GLASS CONNECTOR



OGC-111-ED STD SSS
OGC-111-ED STD PSS
Wall/Floor to Glass
Connector



**OGC-111-ED STD
BM**



**OGC-111-ED STD
ROSE GOLD G-PVD**



OGC-222-ED STD SSS
OGC-222-ED STD PSS
Glass-to-Glass
Connector 135°



**OGC-222-ED STD
BM**



OGC-3 STD SSS
OGC-3 STD PSS
Glass-to-Glass
Connector 90°



**OGC-3 STD
BM**



OGC-4 STD SSS
OGC-4 STD PSS
Wall-to-Glass Connector 90°
(Also available in gold plated)



**OGC-4 STD
BM**



**OGC-4 STD
GOLD G-PVD**



**OGC-4 STD
ROSE GOLD G-PVD**



OGC-333-ED STD SSS
***OGC-333-ED STD PSS**
Glass-to-Glass Connector 90°



**OGC-333-ED STD
BM**



OGC-444-ED STD SSS
***OGC-444-ED STD PSS**
Wall-to-Glass Connector 90°



**OGC-444-ED STD
BM**



**OGC-444-ED STD
ROSE GOLD G-PVD**



OGC-5 STD SSS
OGC-5 STD PSS
Glass-to-Glass
Connector 180°



**OGC-5 STD
BM**



**OGC-5 STD
GOLD G-PVD**



**OGC-5 STD
ROSE GOLD G-PVD**



New
Cut-outs
are
Different

OGC-1SH STD SSS
OGC-1SH STD PSS
Glass-to-Floor Mount



**OGC-1SH STD
BM**



OGC-555-ED STD SSS
OGC-555-ED STD PSS
Glass-to-Glass Connector 180°



**OGC-555-ED STD
BM**

GLASS CONNECTORS

Plus Series for Glass Partition

Glass Thickness: 10-12mm

New
Cut-outs
are
Different



OGC-1+ STD SSS
OGC-1+ STD PSS
Wall-to-Glass Connector



OGC-3+ STD SSS
OGC-3+ STD PSS
Glass-to-Glass Connector 90°



OGC-4+ STD SSS
OGC-4+ STD PSS
Wall-to-Glass Connector 90°



OGC-1E STD PSS
Glass Connector for
Wall / Floor Mounting



OGC-2E STD PSS
Glass-to-Glass
Connector 135°



OGC-3E STD PSS
Glass-to-Glass
Connector 90°



OGC-4E STD PSS
Wall-to-Glass
Connector 90°



OGC-5E STD PSS
Glass-to-Glass
Connector 180°

Glass Thickness: 8-10mm **E** Series

PREMIUM SHOWER HINGES

- Seamless Design
- Water Tight Fitting Ensures No Water Leakage
- Minimum Gap
- Snapfit Cover Cap
- Suitable for glass thickness: 8-10mm



Watch Video



S Series
Premium Collection of
Architectural Hardware

SS-316



TOWEL BARS WITH HANDLES



TOWEL BARS WITH HANDLES



TOWEL BARS WITH HANDLES



Shower Enclosure

Shower Enclosure



OGH-TB-ED STD PSS
Towel Bar with Handle



OGH-TB-3-SWAN CLEAR
250*450 SSS/PSS
Shower Door Handle with
Towel Bar

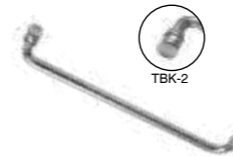

OGH-TBK-2 SSS
OGH-TBK-2 PSS
Towel Bar with Knob



OGH-TB-4 PSS
Shower Door Handle with
Towel Bar



OGH-TB-ED STD BM

*Available on request



OGH-TB-3-SWAN BLUE
250*450 PSS
Shower Door Handle with
Towel Bar

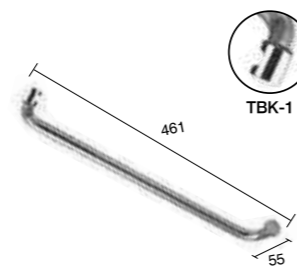

OGH-TBK-1 PSS
Towel Bar with Knob



OGH-11 19x171 SSS
Shower Door Handle



OGH-TB 5 STD SSS
Towel Bar with Handle
(Ø25 mm)

SLIDING SHOWER SCREENS

- E Series**
- Maximum Door Weight: 50kg
 - Maximum Door Width: 750mm
 - Maximum Door Height: 2000mm
 - Maximum Glass Thickness: 8, 10mm

OSSL.SYS.1E 2M CP
OSSL.SYS.1E 3M CP
 Wall-to-Wall System

Available Finishes: BM and CP



Watch Video



OSSL.SYS.90.1E 1.65mx2 CP
 Corner Entry System



Watch Video



SLIDING DOOR SYSTEM - OSL-ED-SYS-11: For Shower Enclosures & Internal Doors

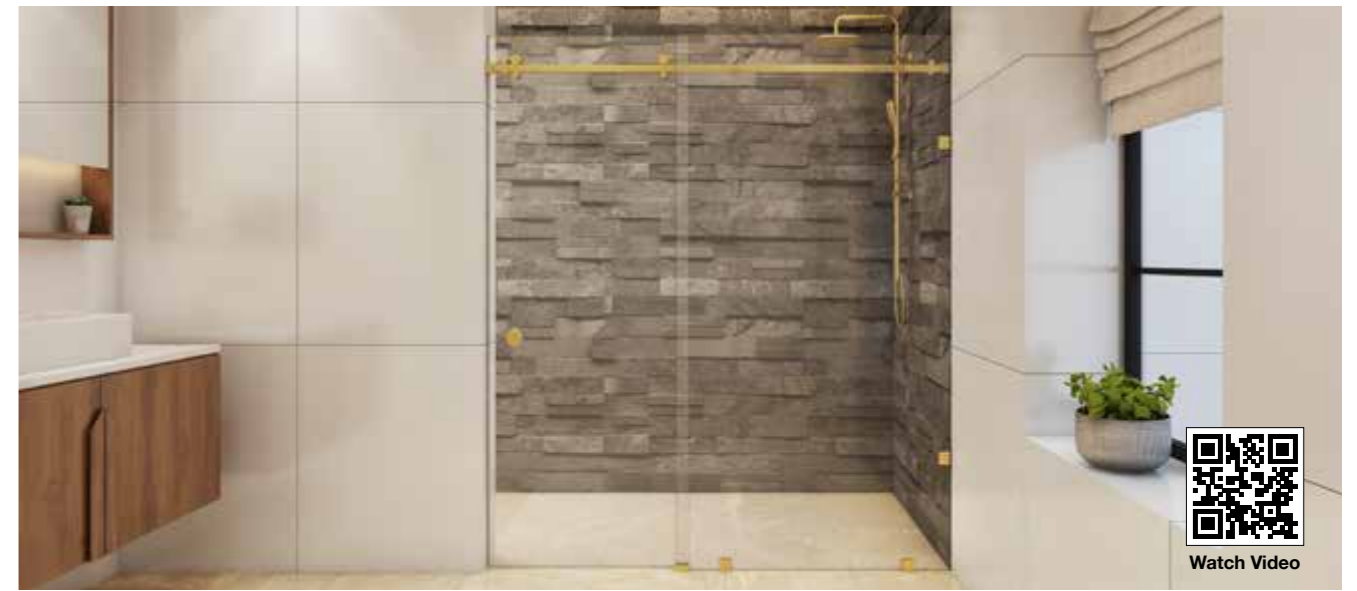

Watch Video

COMPONENT DETAILS

SLIDING SHOWER SCREEN ACCESSORIES		Wall to Wall System	Corner Entry System
	Ø35 Stainless Steel Knob Clamp Roller Finish: Polished or Satin Stainless Steel *Suits 8-10mm Glass Thickness	2 pcs.	4 pcs.
	Aluminium Top Track Finish: Polished or Satin Aluminium	2 meter Length	1.65 meter Length
	Stainless Steel Mounting Bracket (LH/RH) Finish: Polished or Satin Stainless Steel	1 Set (1 LH and 1 RH)	1.65 meter Length
	Nylon End Stopper with Catch Device	2 pcs.	4 pcs.
	Single U-Nylon Floor Guide	1 pc.	2 pcs.
	Track Corner Joint Finish: Polished or Satin Chrome (for Corner Entry System)	N.A.	1 pc.

OPTIONAL ACCESSORIES



ODK-2 STD PSS
Glass Door Knob



OPS-M3 STD
90° Magnetic Seal



OPS-9 STD
Offset Lip Seal



OZGL-UPR-SS
Stainless Steel Channel
For 10 & 12mm Glass
(Available in 900mm & 1660mm Length)



OGC-4 STD SSS
OGC-4 STD PSS
Wall-to-Glass Connector 90°

Product Code (Only for Individual Product Order)	Product Image	How to Order (Available in kits only)	
		OSL-ED-SYS-11 1.65 mtr Kit includes Available Finish: <input type="checkbox"/> PSS	OSL-ED-SYS-11 2 mtr Kit includes Available Finish: <input type="checkbox"/> BM <input type="checkbox"/> GG-PVD <input type="checkbox"/> RGG-PVD
SL-ED-11-A1 STD PSS Sliding Door Roller		02 Sets	02 Sets
SL-ED-11-A2 STD PSS Track to Glass Holder		02 pcs	02 pcs
SL-ED-11-A3 STD PSS Stopper		02 pcs	02 pcs
SL-ED-11-A4 STD PSS Floor Guide		01 pc	01 pc
OSSKH-1-ED STD PSS Wall-to-track Connector		02 pcs	02 pcs
OSSKH-ACC-25T-ED 1.65Mtr PSS OSSKH-ACC-25T-ED 1.65Mtr BM Connector Track		01 pc	-
OSSKH-ACC-25T-ED 2Mtr PSS OSSKH-ACC-25T-ED 2Mtr BM OSSKH-ACC-25T-ED 3Mtr PSS Connector Track <i>(Please note that 2m Track does not have Pre-drilled Holes for A2)</i>		-	01 pc

*against on request

Optional Fitting for 90° Application



SL-ED-11-A6 STD PSS
Track to Glass Holder
Optional for 90° Application

SHOWER KNIGHT HEAD FITTINGS



OSKH-1 STD SSS
OSKH-1 STD PSS
Reinforcing Rod
With Wall Connector
(Also available in gold plated)



OSKH-1 STD
BM



OSKH-1 STD
GOLD G-PVD



OSKH-1 STD
ROSE GOLD G-PVD



OSKH-2 STD SSS
OSKH-2 STD PSS
Reinforcing Rod
Support from Glass Through and
Through (Also available in gold plated)



OSKH-2 STD
BM



OSKH-2 STD
GOLD G-PVD



OSKH-2 STD
ROSE GOLD G-PVD



OSKH-2A STD SSS
OSKH-2A STD PSS
Reinforcing Rod Support
from Glass One Side Blind



OSKH-3 STD SSS
OSKH-3 STD PSS
Reinforcing Rod
Connector Universal



OSKH-3 STD
BM



OSKH-ACC-19 2mtr SSS
OSKH-ACC-19 2mtr PSS
OSKH-ACC-19 3mtr SSS
OSKH-ACC-19 3mtr PSS
OSKH-ACC-19 3mtr BM
Re-inforcing Rod 19mm Diameter



OSKH-ACC-19
BM



OSKH-ACC-19
GOLD G-PVD



OSKH-ACC-19
ROSE GOLD G-PVD



OSKH-1C STD PSS
Reinforcing Bars cum Glass
Support Wall Bracket



OSKH-T STD PSS
Reinforcement Bars for Adjoining
Shower Enclosures



OSKH-3C STD PSS
Pipe Connectors at any
angle for Glass Stabilization

EDGE LINE KNIGHT HEAD FITTINGS



OSSKH-1-ED STD SSS
OSSKH-1-ED STD PSS
Wall-to-track Connector



OSSKH-1-ED STD
BM



OSSKH-1-ED STD
GOLD G-PVD



OSSKH-1-ED STD
ROSE GOLD G-PVD



OSSKH-2-ED STD SSS
OSSKH-2-ED STD PSS
Track to Glass Connector



OSSKH-2-ED STD
BM



OSSKH-2-ED STD
GOLD G-PVD



OSSKH-2-ED STD
ROSE GOLD G-PVD



OSSKH-3-ED STD SSS
OSSKH-3-ED STD PSS
Glass-to-track end Connector
Track-to-Track 90° Connector



OSSKH-3-ED STD
BM



OSSKH-3-ED STD
GOLD G-PVD



OSSKH-3-ED STD
ROSE GOLD G-PVD



OSSKH-ACC-25T-ED 1.65mtr PSS
OSSKH-ACC-25T-ED 2mtr PSS
OSSKH-ACC-25T-ED 3Mtr PSS
Connector Track



OSSKH-ACC-25T-ED
STD BM



OSSKH-ACC-25T-ED
GOLD G-PVD



OSSKH-ACC-25T-ED
ROSE GOLD G-PVD

Door Knobs



ODK-1 STD SSS
ODK-1 STD PSS
Glass Door Knob



***ODK-2 STD SSS**
ODK-2 STD PSS
Glass Door Knob



ODK-22 STD PSS
Glass Door Knob



***ODK-44 STD SSS**
ODK-44 STD PSS
Glass Door Knob

Shower Threshold Profile



***OZ-ST-10mm 2m SSS**
Floor Mounted Glazing Profile For Fixed Glass



***OZ-ST-ACC-CP-10mm 2m SSS**
Cover Profile for OZ-ST-8mm & 10mm

Available in SSS Finish



OUTLINER SERIES

Enhancing aesthetics with minimalistic but visible Outliner to a frameless glass used for Doors, Showers, or Partitions. Giving a new statement to the world of frameless solutions.

OUTLINER SW - 11 SINGLE DOOR WITH PATCH FITTINGS



TYPICAL LAYOUT

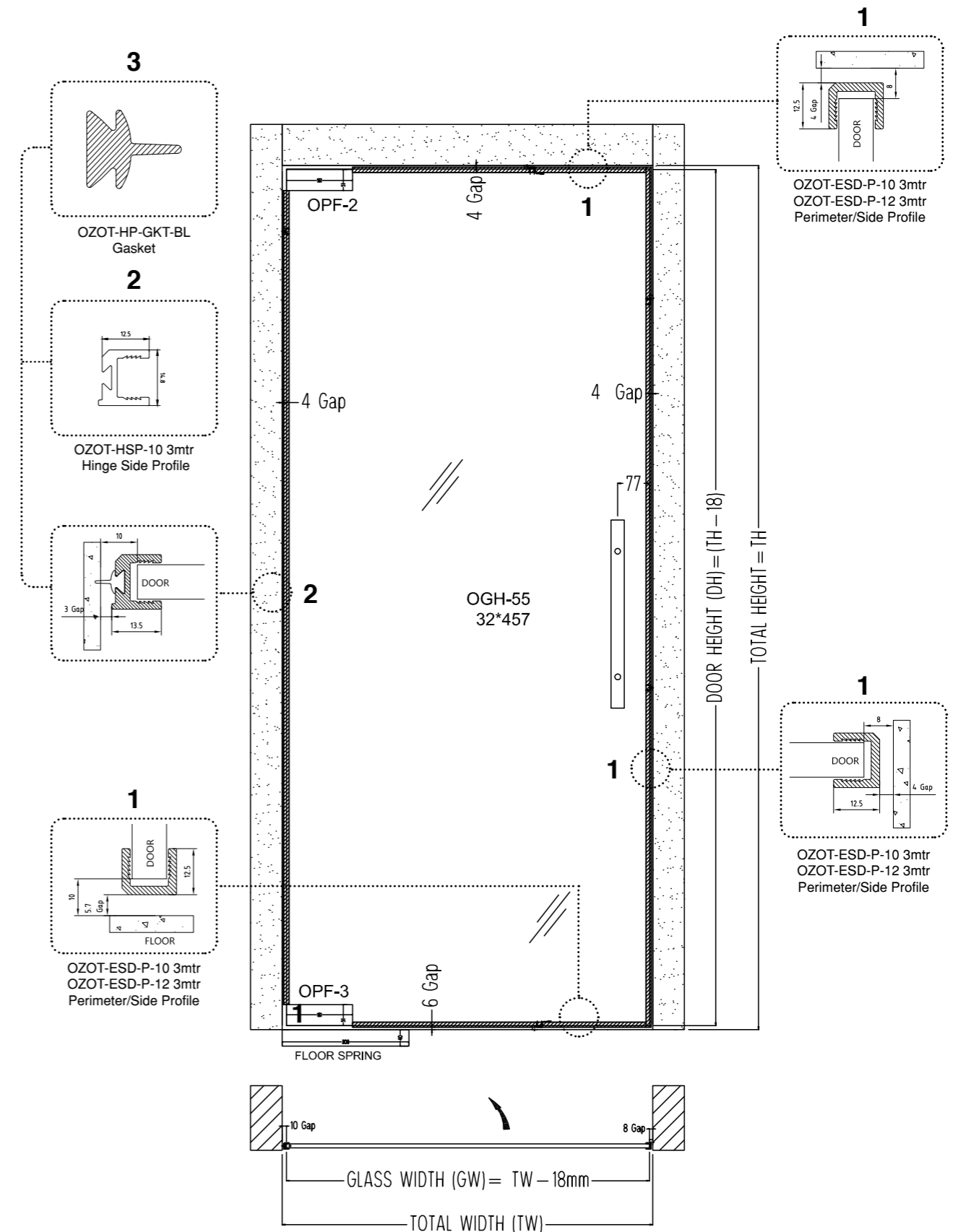

For 10 MM Glass Thickness				
S. No.	Code	Descriptions	Length	QTY.
1	OZOT-ESD-P-10 3mtr BM	Perimeter/Side Profile	3Mtr	2 Nos.
2	OZOT-HSP-10 3mtr BM	Hinge Side Profile	3Mtr	1 Nos.
3	OZOT-HP-GKT BL	Gasket	R/Mtr	3 Nos.

For 12 MM Glass Thickness				
S. No.	Code	Descriptions	Length	QTY.
1	OZOT-ESD-P-12 3mtr BM	Perimeter/Side Profile	3Mtr	2 Nos.
2	OZOT-HSP-12 3mtr BM	Hinge Side Profile	3Mtr	1 Nos.
3	OZOT-HP-GKT BL	Gasket	R/Mtr	3 Nos.

OUTLINER SW - 22 DOUBLE DOOR WITH PATCH FITTINGS



TYPICAL LAYOUT

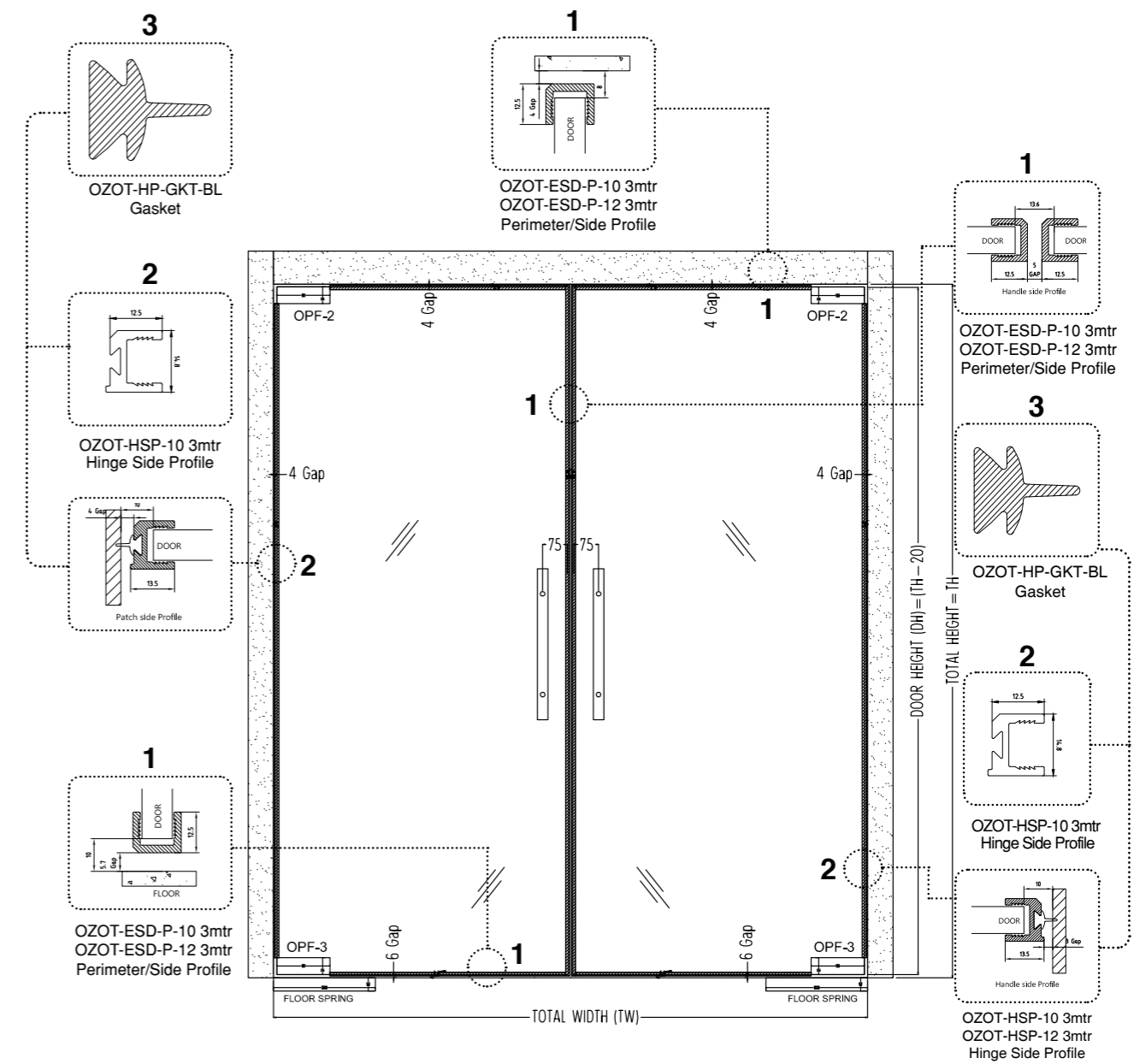

For 10 MM Glass Thickness				
S. No.	Code	Descriptions	Length	QTY.
1	OZOT-ESD-P-10 3mtr BM	Perimeter/Side Profile	3Mtr	4 Nos.
2	OZOT-HSP-10 3mtr BM	Hinge Side Profile	3Mtr	2 Nos.
3	OZOT-HP-GKT BL	Gasket	R/Mtr	6 Nos.
For 12 MM Glass Thickness				
S. No.	Code	Descriptions	Length	QTY.
1	OZOT-ESD-P-12 3mtr BM	Perimeter/Side Profile	3Mtr	4 Nos.
2	OZOT-HSP-12 3mtr BM	Hinge Side Profile	3Mtr	2 Nos.
3	OZOT-HP-GKT BL	Gasket	R/Mtr	6 Nos.

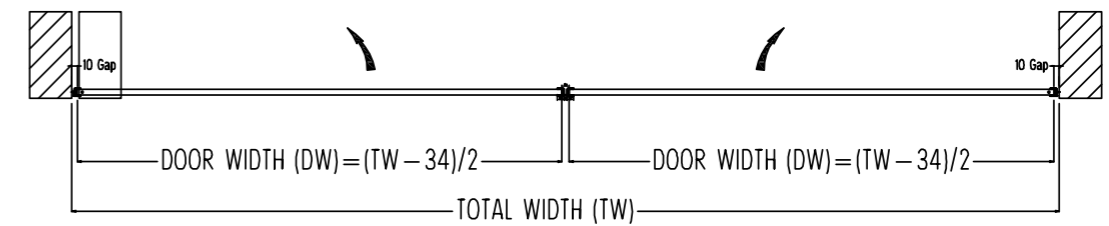

OUTLINER SW - 33 DOUBLE DOOR WITH OVERPANEL



TYPICAL LAYOUT

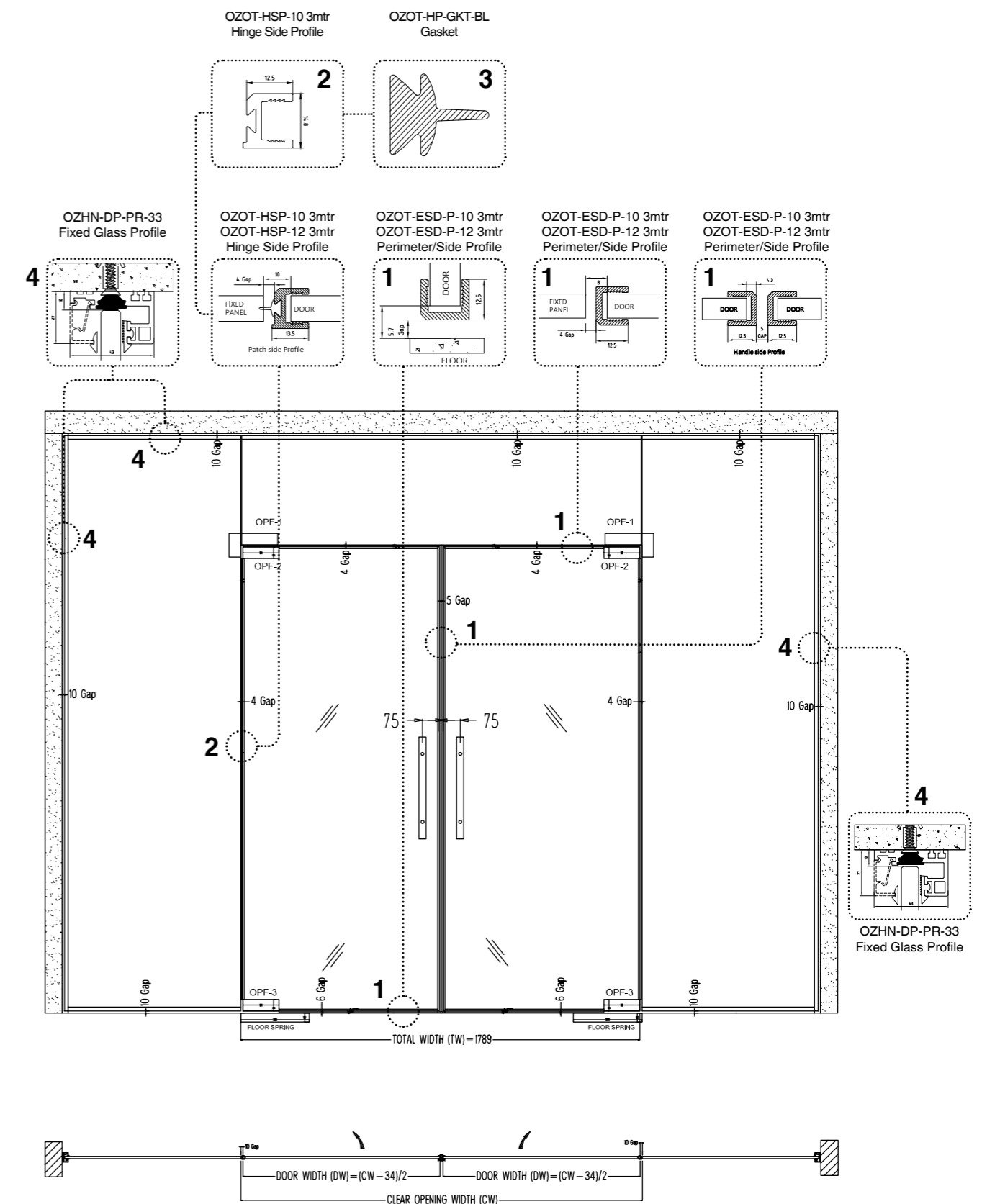

For 10 MM Glass Thickness				
S. No.	Code	Descriptions	Length	QTY.
1	OZOT-ESD-P-10 3mtr BM	Perimeter/Side Profile	3Mtr	2 Nos.
2	OZOT-HSP-10 3mtr BM	Hinge Side Profile	3Mtr	4 Nos.
3	OZOT-HP-GKT BL	Gasket	R/Mtr	2 Nos.
4	OZHN-DP-PR-33 BM	Fixed Glass Profile	4Mtr	As Per Actual

For 12 MM Glass Thickness				
S. No.	Code	Descriptions	Length	QTY.
1	OZOT-ESD-P-12 3mtr BM	Perimeter/Side Profile	3Mtr	2 Nos.
2	OZOT-HSP-12 3mtr BM	Hinge Side Profile	3Mtr	4 Nos.
3	OZOT-HP-GKT BL	Gasket	R/Mtr	2 Nos.
4	OZHN-DP-PR-33 BM	Fixed Glass Profile	4Mtr	As Per Actual

Note: The number of the profiles will change as per the length of the door and according to the site measurement.

OUTLINER SW - 11/22/33 PROFILES



OZOT-ESD-P-10 3mtr BM
Outliner EDGE PROFILE

- Outliner sleek Profile for cladding the edge of glass.
- 12.5X14.8 ALUMINIUM EXTRUDED PROFILE.
- No Screws & Corner cleat is required to fix with glass
- Can be fix with double side tape only.
- Suitable glass thickness 10mm
- Max Profile length 3000
- Suitable for Shower, Sliding Folding and Patch fitting applications.
- Material: Aluminium.
- Finish: BM & AN
- Other Finish can also be available on request.



OZOT-HSP-10 3mtr BM
Outliner HINGE PROFILE

- Outliner Hinge Profile for cladding the edge of Hinge side.
- 12.5X14.8 ALUMINIUM EXTRUDED PROFILE.
- No Screws & Corner cleat is required to fix with glass
- Can be fix with double side tape only.
- Suitable glass thickness 10mm
- Max Profile length 3000
- Suitable for Shower, Sliding Folding and Patch fitting applications.
- Material: Aluminium.
- Finish: BM & AN
- Other Finish can also be available on request.



OZOT-HP-GKT BL
EPDM GASKET

- EPDM Seal for Outliner Hinge Profile.
- Minimize the gap between wall/Floor and profile.



OZHN-DP-PR-33
Fixed Glass Profiles

- Fixed glass profile with cover clip
- 27X43 ALUMINIUM EXTRUDED PROFILE.
- Suitable glass thickness 12mm
- Max Profile length 4 mtr
- Suitable for fixed glass panel applications.
- Material: Aluminium.
- Finish: BM & AN



OZOT-ESD-P-12 3mtr BM
Outliner EDGE PROFILE

- Outliner sleek Profile for cladding the edge of glass.
- 12.5X14.8 ALUMINIUM EXTRUDED PROFILE.
- No Screws & Corner cleat is required to fix with glass
- Can be fix with double side tape only.
- Suitable glass thickness 12mm
- Max Profile length 3000
- Suitable for Shower, Sliding Folding and Patch fitting applications.
- Material: Aluminium.
- Finish: BM & AN
- Other Finish can also be available on request.



OZOT-HSP-12 3mtr BM
Outliner HINGE PROFILE

- Outliner Hinge Profile for cladding the edge of Hinge side.
- 12.5X14.8 ALUMINIUM EXTRUDED PROFILE.
- No Screws & Corner cleat is required to fix with glass
- Can be fix with double side tape only.
- Suitable glass thickness 12mm
- Max Profile length 3000
- Suitable for Shower, Sliding Folding and Patch fitting applications.
- Material: Aluminium.
- Finish: BM & AN
- Other Finish can also be available on request.



OZOT-HP-GKT BL
EPDM GASKET

- EPDM Seal for Outliner Hinge Profile.
- Minimize the gap between wall/Floor and profile.



OZHN-DP-PR-33
Fixed Glass Profiles

- Fixed glass profile with cover clip
- 27X43 ALUMINIUM EXTRUDED PROFILE.
- Suitable glass thickness 12mm
- Max Profile length 4 mtr
- Suitable for fixed glass panel applications.
- Material: Aluminium.
- Finish: BM & AN

OUTLINER SLICK SW-11/22/33



OPF-2 X 1Nos.
Top Patch
Variable pivot point of 55 or 65mm
With SS 304 cover of OCFH-100
Cover secured with small 'L' key
Pivot pin of 15mm diameter
Adjustable pivot point 55 or 65mm



OPF-3 X 1 Nos.
Bottom Patch
Variable pivot point of 55 or 65mm
Compatible with Ozone Floor Spring
Base Material Casting: Aluminium Alloy
Quick Release Covers



OFS-ACC-GDP X 1 Nos.
Top Pivot for Patch/Point Fitting Doors
Stainless Steel Pivot
Wear Resistant Pivot Pin
Pivot Held in Overhead Structure



OGH-11 BM
Glass Door Handle
With gaskets to prevent glass damage
Sleek construction
Handle on both sides
Can be used on sliding door also



OPL-1 X 1Nos.
Corner Patch Lock with Strike Plate
With a euro profile cylinder
and strike plate
Dead bolt projection of 15mm
(single throw)
Three high security computer keys
Cover secured with small 'L' key
1.5mm thick SS 316 cover plate
Cover plate secured with a snap-fit mechanism



OGH-55-BM
H Type Handle
Pull Handle With Back to Back installation
on Glass/Wooden/Metals Doors.
Gaskets to prevent the contact between
glass and metal.
Supporting washer with raised bevelling
on the outer surface.
Material:-Stainless Steel Grade 304.
Finish: Double Finish of PSS/SSS &
Single Finish of SSS.



OCFH-100 X 1 Nos.
The Original SELF-CLOSING
Patch Fitting
Quick and easy installation
Suitable door weight: Max 100kg.
Suitable door width: 750~1000mm
Suitable door thickness: 8~12mm
Ambient temperature: -20°C to +50°C



OPF-1 STD BM
Over Panel Side Panel
Connecting Patch with Pivot
Quick and easy installation
Ambient temperature: -20°C to +50°C



FS-8400-S X 1Nos.
Floor Spring
Maximum door weight : 80Kg
Closing speed : 130-10
Final closing speed : 10-0
Hold Open (standard): 90 hold open
Installation dim.: Length-306mm,
Width-108mm, Height-40mm
10 Years Guarantee against
manufacturing defect only

OUTLINER EN-11 WALL-TO-GLASS SHOWER ENCLOSURE



TYPICAL LAYOUT

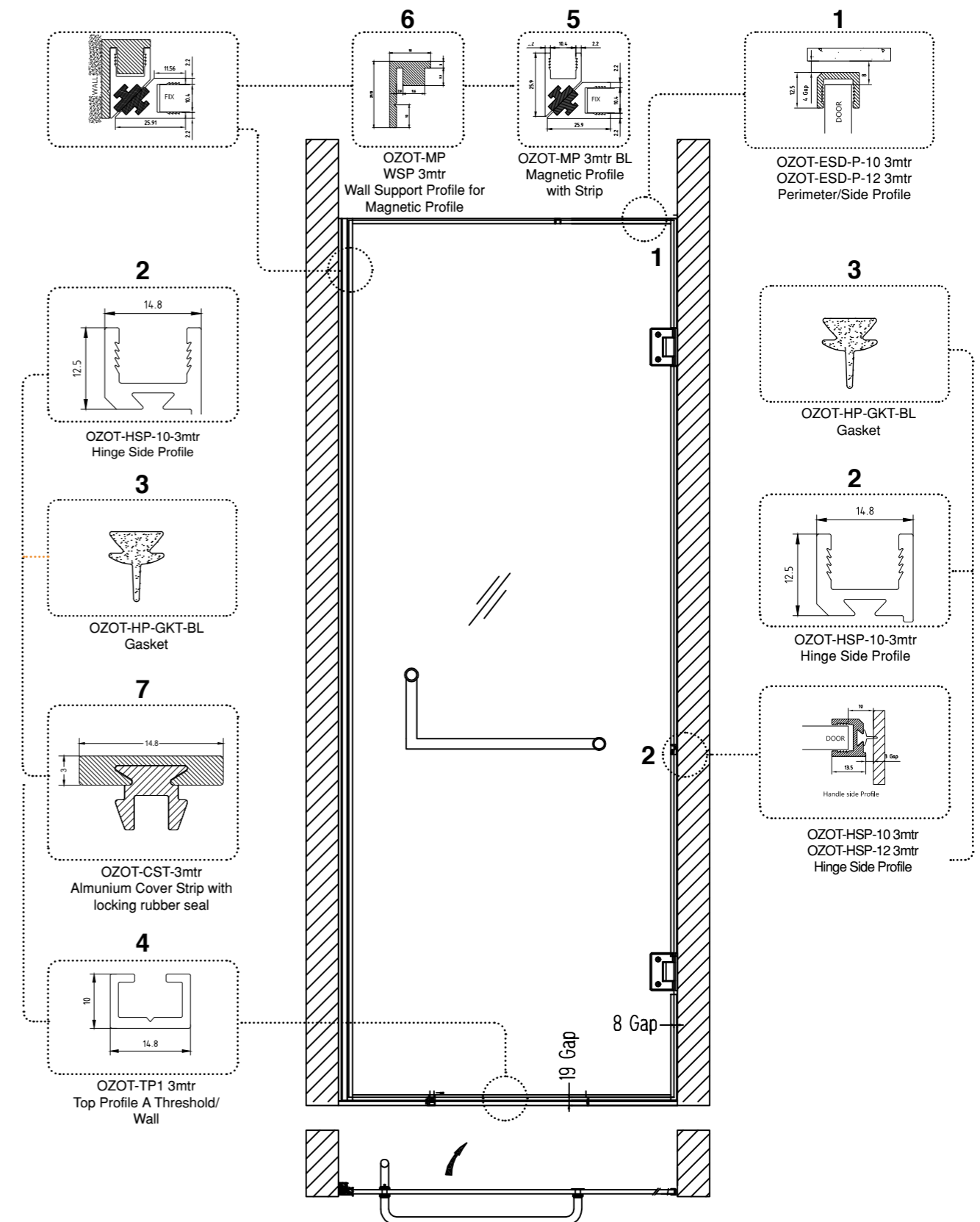

For 10 MM Glass Thickness				
S. No.	Code	Descriptions	Length	QTY.
1	OZOT-ESD-P-10 3mtr BM	Perimeter/Side Profile	3Mtr	1 Nos.
2	OZOT-HSP-10 3mtr BM	Hinge Side Profile	3Mtr	1 Nos.
3	OZOT-HP-GKT BL	Gasket	R/Mtr	3 Nos.
4	OZOT-TP1 3mtr BM	Top Profile A Threshold/Wall	3Mtr	1 Nos.
5	OZOT-MP 3mtr BL	Magnetic Profile with Strip	3Mtr	1 Nos.
6	OZOT-MP-WSP 3mtr BM	Wall Support Profile for Magnetic Profile	3Mtr	1 Nos.
7	OZOT-CST 3mtr BM	Almunium Cover Strip with locking rubber seal	3Mtr	1 Nos.

OUTLINER EN - 22 GLASS-TO-GLASS 90° SHOWER ENCLOSURE



TYPICAL LAYOUT

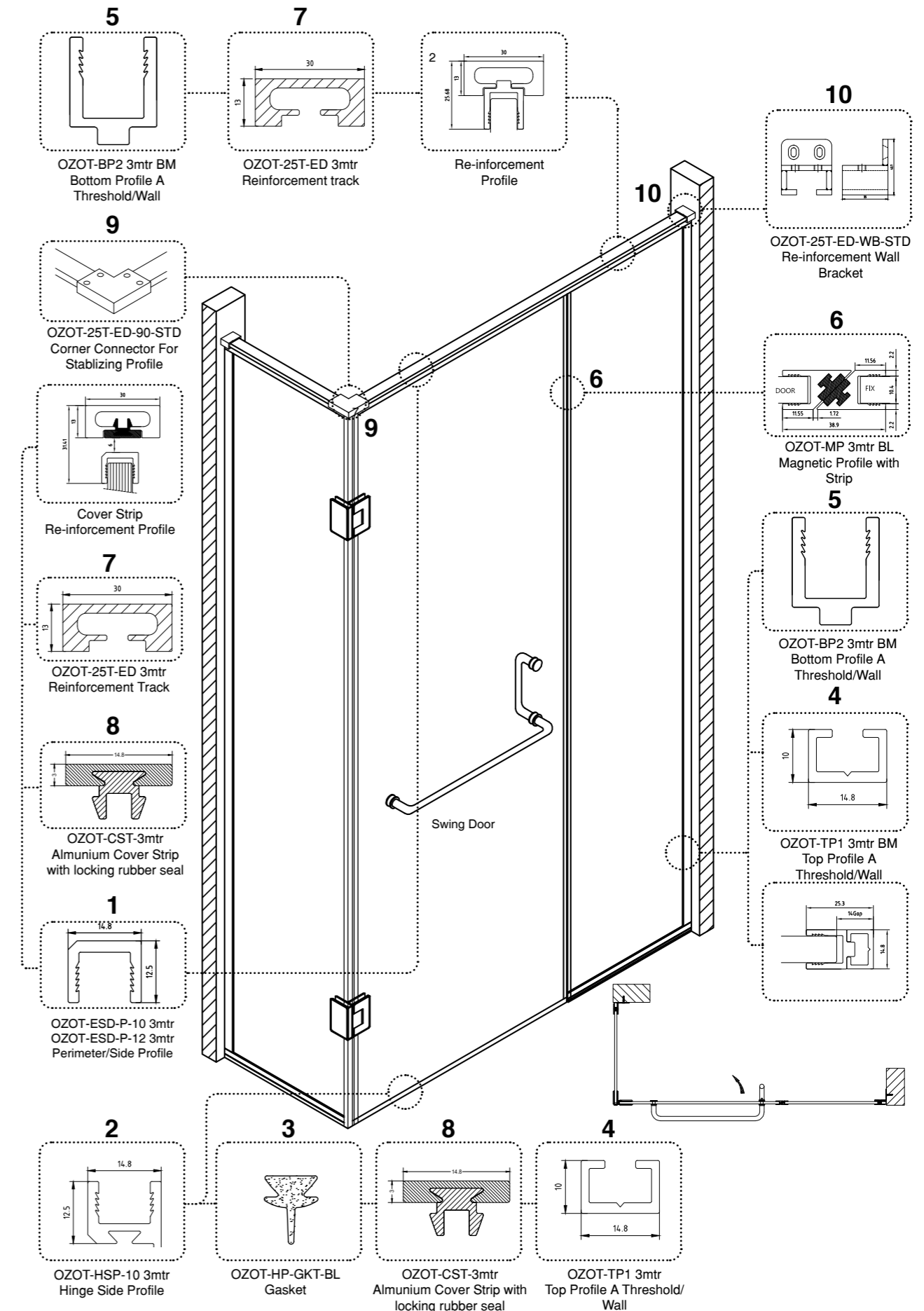

For 10 MM Glass Thickness				
S. No.	Code	Descriptions	Length	QTY.
1	OZOT-ESD-P-10 3mtr BM	Perimeter/Side Profile	3Mtr	1 Nos.
2	OZOT-HSP-10 3mtr BM	Hinge Side Profile	3Mtr	1 Nos.
3	OZOT-HP-GKT BL	Gasket	R/Mtr	3 Nos.
4	OZOT-TP1 3mtr BM	Top Profile A Threshold/Wall	3Mtr	3 Nos.
5	OZOT-BP2 3mtr BM	Bottom Profile A Threshold/Wall	3Mtr	3 Nos.
6	OZOT-MP 3mtr BL	Magnetic Profile with Strip	3Mtr	1 Nos.
7	OZOT-25T-ED 3mtr BM	Reinforcement track	3Mtr	1 Nos.
8	OZOT-CST 3mtr BM	Almunium Cover Strip with locking rubber seal	3Mtr	1 Nos.
9	OZOT-25T-ED-90-STD BM	Corner Connector For Stabilizing Profile	N/A	1 Nos.
10	OZOT-25T-ED-WB-STD BM	Re-inforcement Wall Bracket	N/A	2 Nos.

OUTLINER EN - 33 GLASS-TO-GLASS 90° SHOWER ENCLOSURE



TYPICAL LAYOUT

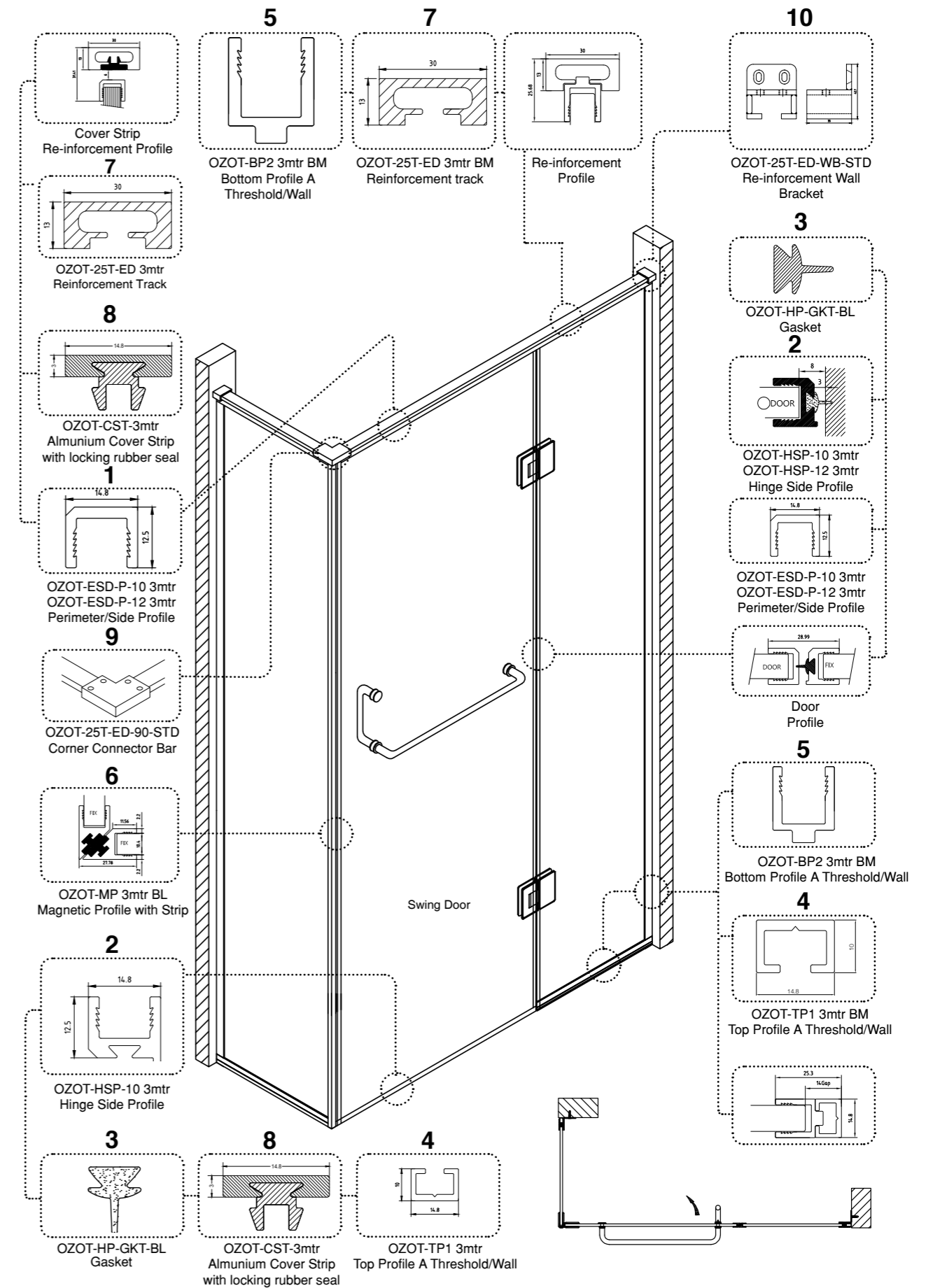

For 10 MM Glass Thickness				
S. No.	Code	Descriptions	Length	QTY.
1	OZOT-ESD-P-10 3mtr BM	Perimeter/Side Profile	3Mtr	1 Nos.
2	OZOT-HSP-10 3mtr BM	Hinge Side Profile	3Mtr	1 Nos.
3	OZOT-HP-GKT BL	Gasket	R/Mtr	3 Nos.
4	OZOT-TP1 3mtr BM	Top Profile A Threshold/Wall	3Mtr	3 Nos.
5	OZOT-BP2 3mtr BM	Bottom Profile A Threshold/Wall	3Mtr	3 Nos.
6	OZOT-MP 3mtr BL	Magnetic Profile with Strip	3Mtr	1 Nos.
7	OZOT-25T-ED 3mtr BM	Reinforcement track	3Mtr	1 Nos.
8	OZOT-CST 3mtr BM	Almunium Cover Strip with locking rubber seal	3Mtr	1 Nos.
9	OZOT-25T-ED-90-STD BM	Corner Connector For Stablizing Profile	N/A	1 Nos.
10	OZOT-25T-ED-WB-STD BM	Re-inforcement Wall Bracket	N/A	2 Nos.

OUTLINER EN - 44 GLASS-TO-GLASS 180° SHOWER ENCLOSURE



TYPICAL LAYOUT

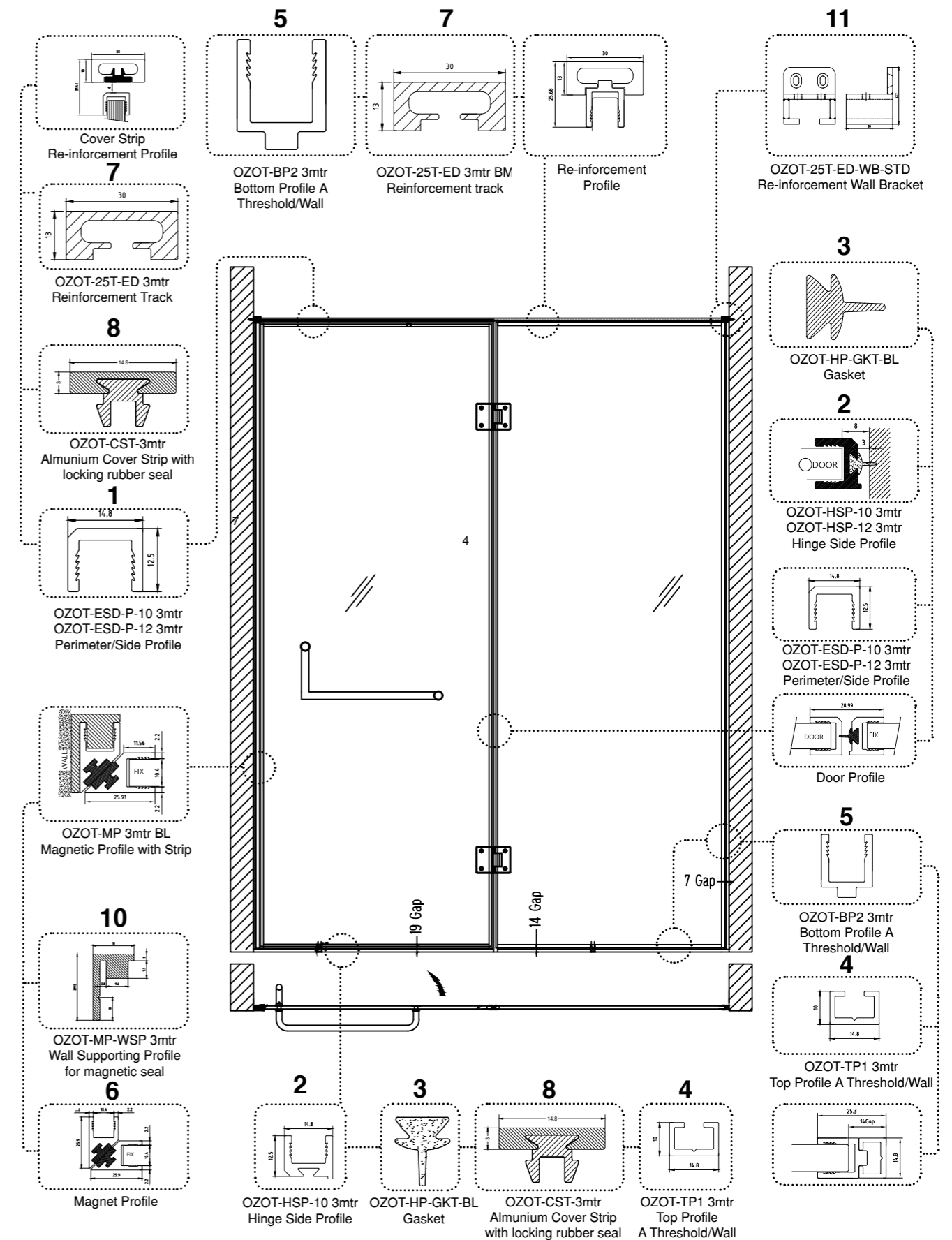

For 10 MM Glass Thickness				
S. No.	Code	Descriptions	Length	QTY.
1	OZOT-ESD-P-10 3mtr BM	Perimeter/Side Profile	3Mtr	1 Nos.
2	OZOT-HSP-10 3mtr BM	Hinge Side Profile	3Mtr	1 Nos.
3	OZOT-HP-GKT BL	Gasket	R/Mtr	3 Nos.
4	OZOT-TP1 3mtr BM	Top Profile A Threshold/Wall	3Mtr	2 Nos.
5	OZOT-BP2 3mtr BM	Bottom Profile A Threshold/Wall	3Mtr	2 Nos.
6	OZOT-MP 3mtr BL	Magnetic Profile with Strip	3Mtr	1 Nos.
7	OZOT-25T-ED 3mtr BM	Reinforcement track	3Mtr	1 Nos.
8	OZOT-CST 3mtr BM	Almunium Cover Strip with locking rubber seal	3Mtr	2 Nos.
9	OZOT-25T-ED-WB-STD BM	Re-inforcement Wall Bracket	N/A	1 Nos.
10	OZOT-MP WSP	Wall supporting profile for magnetic seal (WtoG)	3Mtr	1 Nos.

OUTLINER EN - 55 WALL-TO-GLASS 180° SHOWER ENCLOSURE



TYPICAL LAYOUT

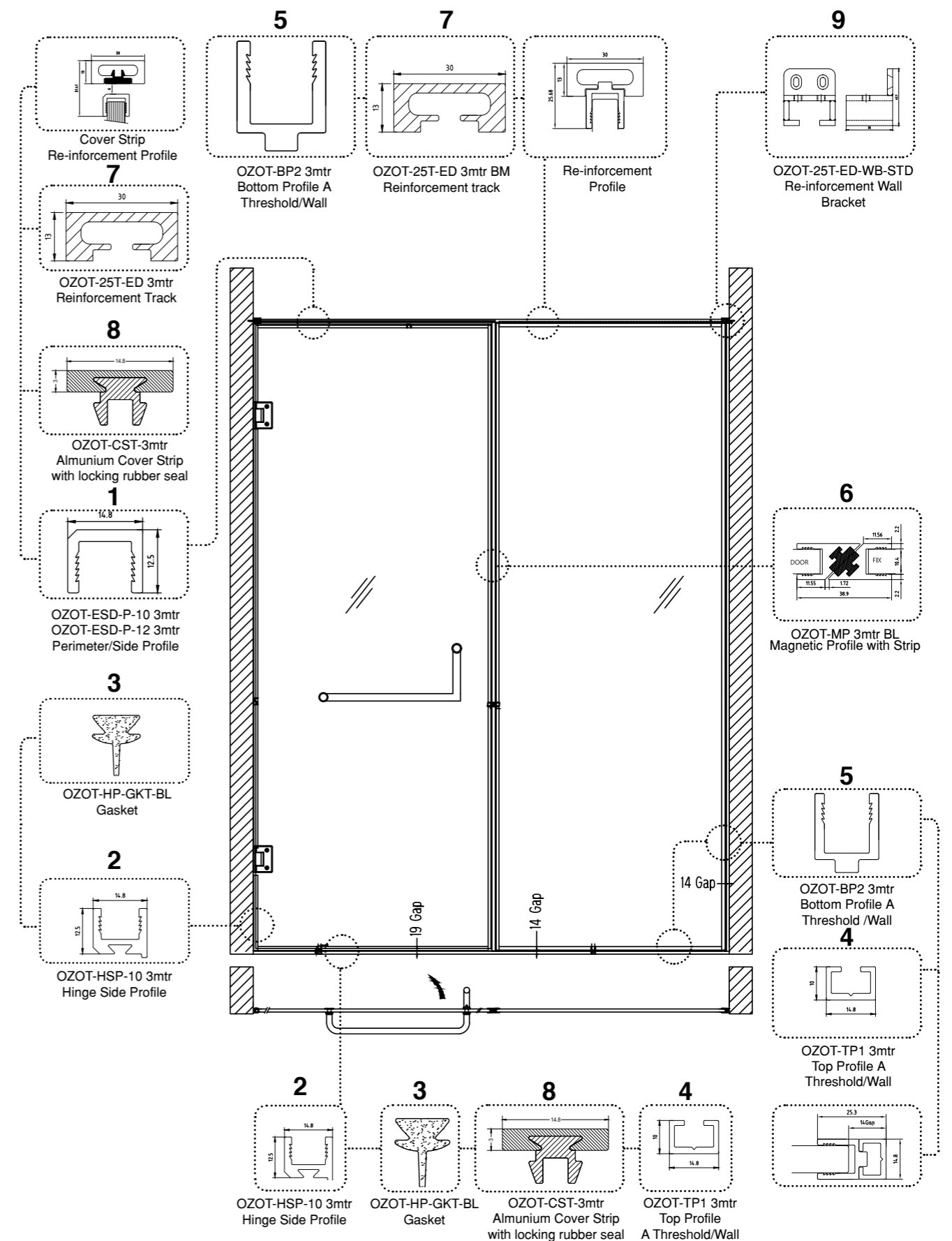

For 10 MM Glass Thickness				
S. No.	Code	Descriptions	Length	QTY.
1	OZOT-ESD-P-10 3mtr BM	Perimeter/Side Profile	3Mtr	1 Nos.
2	OZOT-HSP-10 3mtr BM	Hinge Side Profile	3Mtr	1 Nos.
3	OZOT-HP-GKT BL	Gasket	R/Mtr	3 Nos.
4	OZOT-TP1 3mtr BM	Top Profile A Threshold/Wall	3Mtr	2 Nos.
5	OZOT-BP2 3mtr BM	Bottom Profile A Threshold/Wall	3Mtr	2 Nos.
6	OZOT-MP 3mtr BL	Magnetic Profile with Strip	3Mtr	1 Nos.
7	OZOT-25T-ED 3mtr BM	Reinforcement track	3Mtr	1 Nos.
8	OZOT-CST 3mtr BM	Almunium Cover Strip with locking rubber seal	3Mtr	1 Nos.
9	OZOT-25T-ED-WB STD	Re-inforcement Wall Bracket	N/A	2 Nos.

OUTLINER EN - 11/22/33/44/55 PROFILES

OUTLINER EN - 11/22/33/44/55 PROFILES



OZOT-ESD-P-10 3mtr BM
Outliner EDGE PROFILE

- Outliner sleek Profile for cladding the edge of glass.
- 12.5X14.8 ALUMINIUM EXTRUDED PROFILE.
- No Screws & Corner cleat is required to fix with glass
- Can be fix with double side tape only.
- Suitable glass thickness 10mm
- Max Profile length 3000
- Suitable for Shower, Sliding Folding and Patch fitting applications.
- Material: Aluminium.
- Finish: BM & AN
- Other Finish can also be available on request.



OZOT-HSP-10 3mtr BM
Outliner HINGE PROFILE

- Outliner sleek Profile for cladding the edge of Hinge side.
- 12.5X14.8 ALUMINIUM EXTRUDED PROFILE.
- No Screws & Corner cleat is required to fix with glass
- Can be fix with double side tape only.
- Suitable glass thickness 10mm
- Max Profile length 3000
- Suitable for Shower, Sliding Folding and Patch fitting applications.
- Material: Aluminium.
- Finish: BM & AN
- Other Finish can also be available on request.



OZOT-HP-GKT BL
EPDM GASKET

- EPDM Seal for Outliner Hinge Profile.
- Minimize the gap between wall/Floor and profile.

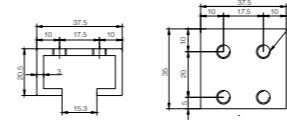

OZOT-25T-ED-WB-STD
WALL BRACKET-PART-A

- Wall Bracket for Stablizing Support Profile
- Material: Aluminium.
- Finish: BM & AN
- Other Finish can also be available on request.



OZOT-25T-ED-90-STD
CORNER CONNECTOR FOR STABILIZING PROFILE

- CORNER CONNECTOR FOR STABILIZING PROFILE for 90 Degree Shower
- Material: Aluminium.
- Finish: BM & AN
- Other Finish can also be available on request.



OZOT-HP-GKT BL
EPDM GASKET

- EPDM Seal for Outliner Hinge Profile.
- Minimize the gap between wall/Floor and profile.



OZOT-TP1 3mtr
Top Profile A Threshold/Wall

- Outliner sleek Profile for cladding the edge of glass.
- 12.5X14.8 ALUMINIUM EXTRUDED PROFILE.
- No Screws & Corner cleat is required to fix with glass
- Can be fix with double side tape only.
- Suitable glass thickness 10mm
- Max Profile length 3000
- Suitable for Shower, Sliding Folding and Patch fitting applications.
- Material: Aluminium.
- Finish: BM & AN
- Other Finish can also be available on request.



OZOT-BP2 3mtr
Bottom Profile A Threshold/Wall

- Wall connecting profile
- 15X14.8 ALUMINIUM EXTRUDED PROFILE.
- Can be fix to wall ro floor with Screws
- Max Profile length 3000
- Material: Aluminium.
- Finish: BM & AN
- Other Finish can also be available on request.

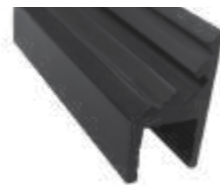

OZOT-MP 3mtr BL
MAGNETIC PROFILE

- Magnetic Profile
- 25.9X14.8 ALUMINIUM EXTRUDED PROFILE.
- No Screws & Corner cleat is required to fix with glass
- Can be fix with double side tape only.
- Suitable glass thickness 12mm
- Max Profile length 3000
- Material: Aluminium.
- Finish: BM & AN
- Other Finish can also be available on request.



OSH-1S STD BM
Wall-To-Glass Hinge

- Seamless Design
- Water Tight Fitting Ensures No Water Leakage
- Minimum Gap
- Snapfit Cover Cap
- Suitable for glass thickness: 8-10mm



OGH-TB-ED STD BM
Towel Bar With Handle

- Water Tight Fitting Ensures No Water Leakage
- Minimum Gap
- Snapfit Cover Cap
- Suitable for glass thickness: 8-10mm



OSSH-44-ED STD BM
Glass-to-Glass Hinge 90°

- Secure Holding with Glass
- Door Weight Max. 40 Kgs
- With Gaskets to Prevent glass Damage
- Door Width Max. 750mm
- Suitable for Glass Thickness 8/10mm
- SS 304 Grade Material
- Matt Black Finish

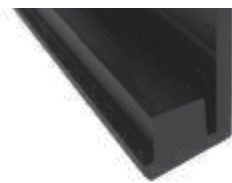

OZOT-MP-WSP 3mtr
WALL SUPPORT PROFILE FOR MAGNETIC PROFILE

- Wall Support Profile for Magnetic Profile
- 25.9X14.8 ALUMINIUM EXTRUDED PROFILE.
- No Screws & Corner cleat is required to fix with glass
- Can be fix with double side tape only.
- Suitable glass thickness 10mm
- Max Profile length 3000
- Material: Aluminium.
- Finish: BM & AN
- Other Finish can also be available on request.



OZOT-25T-ED 2/3mtrs
STABILIZING PROFILE

- Stablizing Support Profile
- 13X30ALUMINIUM EXTRUDED PROFILE.
- Max Profile length 3000
- Material: Aluminium.
- Finish: BM & AN
- Other Finish can also be available on request.



OZOT-CST 3mtrs
ALMUNIUM COVER STRIP WITH LOCKING RUBBER SEAL

- Cover Strip Stablizing Support Profile.
- Cover Strip Cleats



OGH-TB-1 STD BM
Towel Bar with Handle

- Seamless Design
- Water Tight Fitting Ensures No Water Leakage
- Minimum Gap
- Snapfit Cover Cap
- Suitable for glass thickness: 8-10mm



OSH-2S STD BM
Glass-to-Glass 180° Hinge

- Seamless Design
- Water Tight Fitting Ensures No Water Leakage
- Minimum Gap
- Snapfit Cover Cap
- Suitable for glass thickness: 8-10mm

OUTLINER FOLD OS-444 OFFSET SLIDING DOOR SYSTEM



TYPICAL LAYOUT

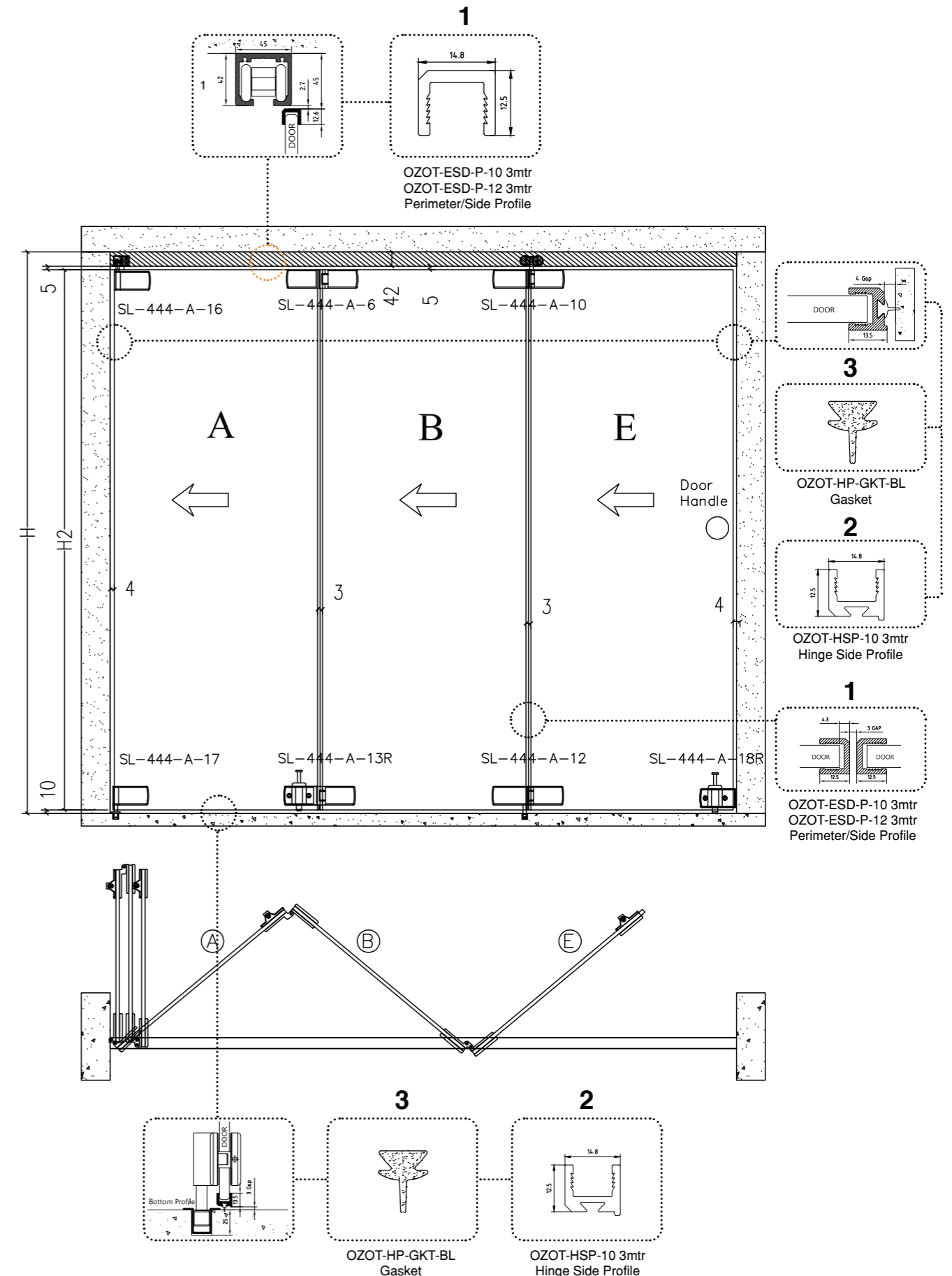

For 10 MM Glass Thickness				
S. No.	Code	Descriptions	Length	QTY.
1	OZOT-ESD-P-10 3mtr BM	Perimeter/Side Profile	3Mtr	4 Nos.
2	OZOT-HSP-10 3mtr BM	Hinge Side Profile	3Mtr	4 Nos.
3	OZOT-HP-GKT BL	Gasket	R/Mtr	12 Nos.
For 12 MM Glass Thickness				
S. No.	Code	Descriptions	Length	QTY.
1	OZOT-ESD-P-12 3mtr BM	Perimeter/Side Profile	3Mtr	4 Nos.
2	OZOT-HSP-12 3mtr BM	Hinge Side Profile	3Mtr	4 Nos.
3	OZOT-HP-GKT BL	Gasket	R/Mtr	12 Nos.

OUTLINER FOLD CS-444 CENTER SLIDING FOLDING SYSTEM



TYPICAL LAYOUT

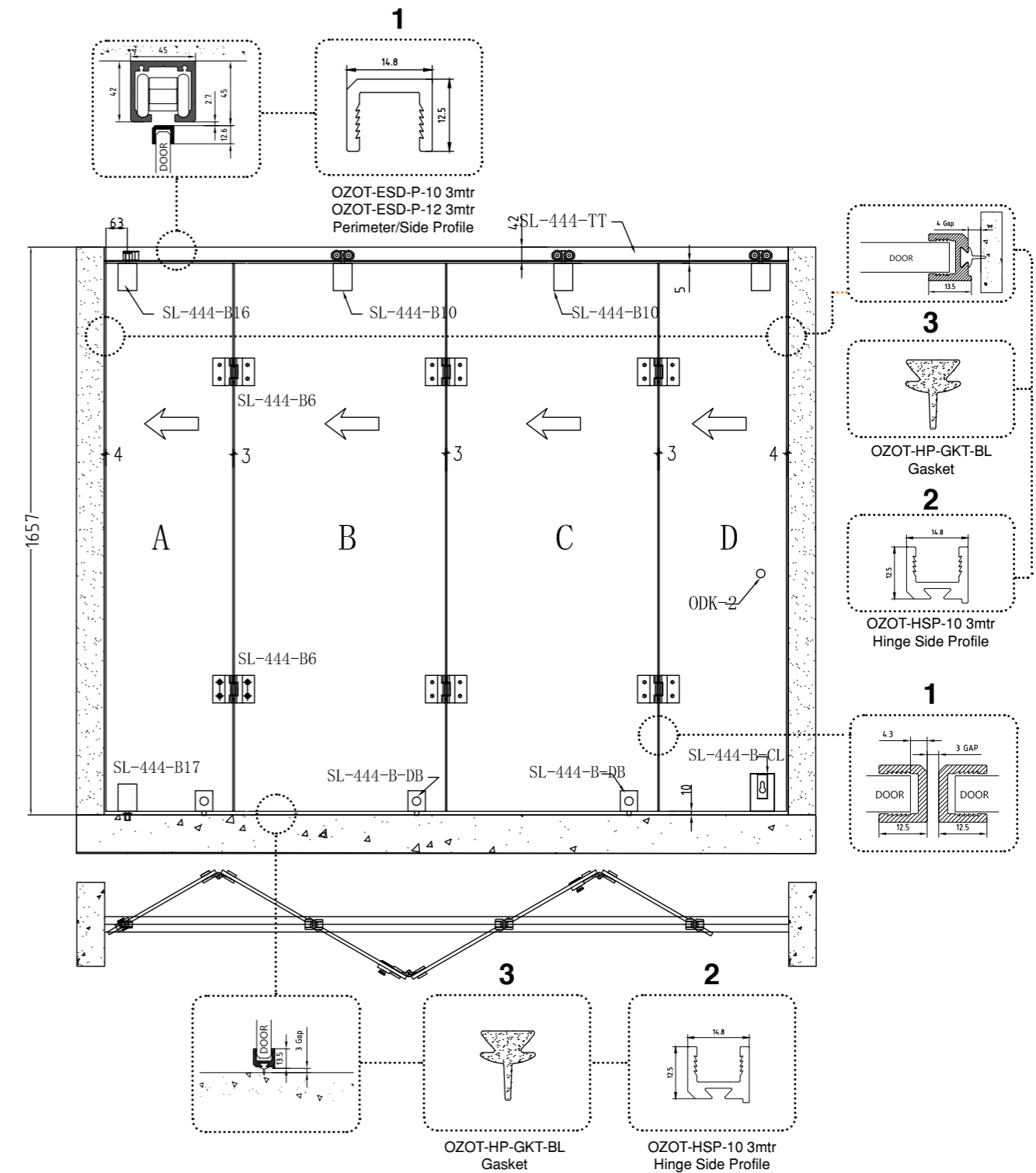

For 10 MM Glass Thickness				
S. No.	Code	Descriptions	Length	QTY.
1	OZOT-ESD-P-10 3mtr BM	Perimeter/Side Profile	3Mtr	4 Nos.
2	OZOT-HSP-10 3mtr BM	Hinge Side Profile	3Mtr	4 Nos.
3	OZOT-HP-GKT BL	Gasket	R/Mtr	12 Nos.
For 12 MM Glass Thickness				
S. No.	Code	Descriptions	Length	QTY.
1	OZOT-ESD-P-12 3mtr BM	Perimeter/Side Profile	3Mtr	4 Nos.
2	OZOT-HSP-12 3mtr BM	Hinge Side Profile	3Mtr	4 Nos.
3	OZOT-HP-GKT BL	Gasket	R/Mtr	12 Nos.

OUTLINER FOLD OS-444/CS-444 CENTER SLIDING FOLDING SYSTEM PROFILES



OZOT-ESD-P-10 3mtr BM
Outliner EDGE PROFILE

- Outliner sleek Profile for cladding the edge of glass.
- 12.5X14.8 ALUMINIUM EXTRUDED PROFILE.
- No Screws & Corner cleat is required to fix with glass
- Can be fix with double side tape only.
- Suitable glass thickness 10mm
- Max Profile length 3000
- Suitable for Shower, Sliding Folding and Patch fitting applications.
- Material: Aluminium.
- Finish: BM & AN
- Other Finish can also be available on request.



OZOT-ESD-P-12 3mtr BM
Outliner EDGE PROFILE

- Outliner sleek Profile for cladding the edge of glass.
- 12.5X14.8 ALUMINIUM EXTRUDED PROFILE.
- No Screws & Corner cleat is required to fix with glass
- Can be fix with double side tape only.
- Suitable glass thickness 12mm
- Max Profile length 3000
- Suitable for Shower, Sliding Folding and Patch fitting applications.
- Material: Aluminium.
- Finish: BM & AN
- Other Finish can also be available on request.



OZOT-HSP-10 3mtr BM
Outliner HINGE PROFILE

- Outliner Hinge Profile for cladding the edge of Hinge side.
- 12.5X14.8 ALUMINIUM EXTRUDED PROFILE.
- No Screws & Corner cleat is required to fix with glass
- Can be fix with double side tape only.
- Suitable glass thickness 10mm
- Max Profile length 3000
- Suitable for Shower, Sliding Folding and Patch fitting applications.
- Material: Aluminium.
- Finish: BM & AN
- Other Finish can also be available on request.



OZOT-HSP-12 3mtr BM
Outliner HINGE PROFILE

- Outliner Hinge Profile for cladding the edge of Hinge side.
- 12.5X14.8 ALUMINIUM EXTRUDED PROFILE.
- No Screws & Corner cleat is required to fix with glass
- Can be fix with double side tape only.
- Suitable glass thickness 12mm
- Max Profile length 3000
- Suitable for Shower, Sliding Folding and Patch fitting applications.
- Material: Aluminium.
- Finish: BM & AN
- Other Finish can also be available on request.



OZOT-HP-GKT BL
EPDM GASKET

- EPDM Seal for Outliner Hinge Profile.
- Minimize the gap between wall/Floor and profile.



OZOT-HP-GKT BL
EPDM GASKET

- EPDM Seal for Outliner Hinge Profile.
- Minimize the gap between wall/Floor and profile.

OUTLINER FOLD CS-444



SL-444-B10 BM
Folding Door Roller



SL-444-B6 BM
Glass-to-Glass Hinges



SL-444-B16 BM
Upper Fixing Clip



SL-444-B17 BM
Lower Fixing Clip



SL-444-TT 3mtr BM
SL-444-TT 4mtr BM
Top Track



SL-444-B-CL BM
Corner Patch Lock



SL-444-B-DB BM
Glass Door Bolt



SL-444-B-SLV BM
Bolt Sleeve



SL-444-B-SP BM
Strike Plate

OUTLINER FOLD OS-444



SL-444-TT 3mtr BM
SL-444-TT 4mtr BM
Top Track



SL-444-A10 STD BM
Glass-to-Glass
Connector with Roller



SL-444-BT 3mtr BM
SL-444-BT 4mtr BM
Bottom Track



SL-444-A11 STD BM
End Sliding Folding Panel
Fitting with Roller



SL-444-TT-C 3mtr BM
SS Cover for track SL-444-TT



SL-444-A12 STD BM
Glass-to-Glass Connecting
Hinge with Guide Locator



SL-444-A6 STD BM
Glass-to-Glass
Interconnecting Hinge



SL-444-A13-L/R STD BM
Glass-to-Glass Connecting
Hinge with Floor Lock

OUTLINER FOLD OS-444



SL-444-A9 STD BM
Glass-to-Wall Hinge
for Single Action Doors



SL-444-A14 STD BM
End Sliding Folding Panel
Fitting with Guide Locator



SL-444-A16 STD BM
End Panel Fitting with
Top Pivot



SL-444-A17 STD BM
End Panel Fitting with
Bottom Pivot



SL-444-A18-L STD BM
End Panel Fitting with
Bottom Pivot (for odd Panels)



SL-444-A18-R STD BM
End Panel Fitting with
Bottom Pivot (for odd panels)



SDL-14A STD BM
Sliding Door Lock with Knob



SDL-14B STD BM
Sliding Door Strike Box
with Knob

OUTLINER AUTO PRO AUTOMATIC



TYPICAL LAYOUT

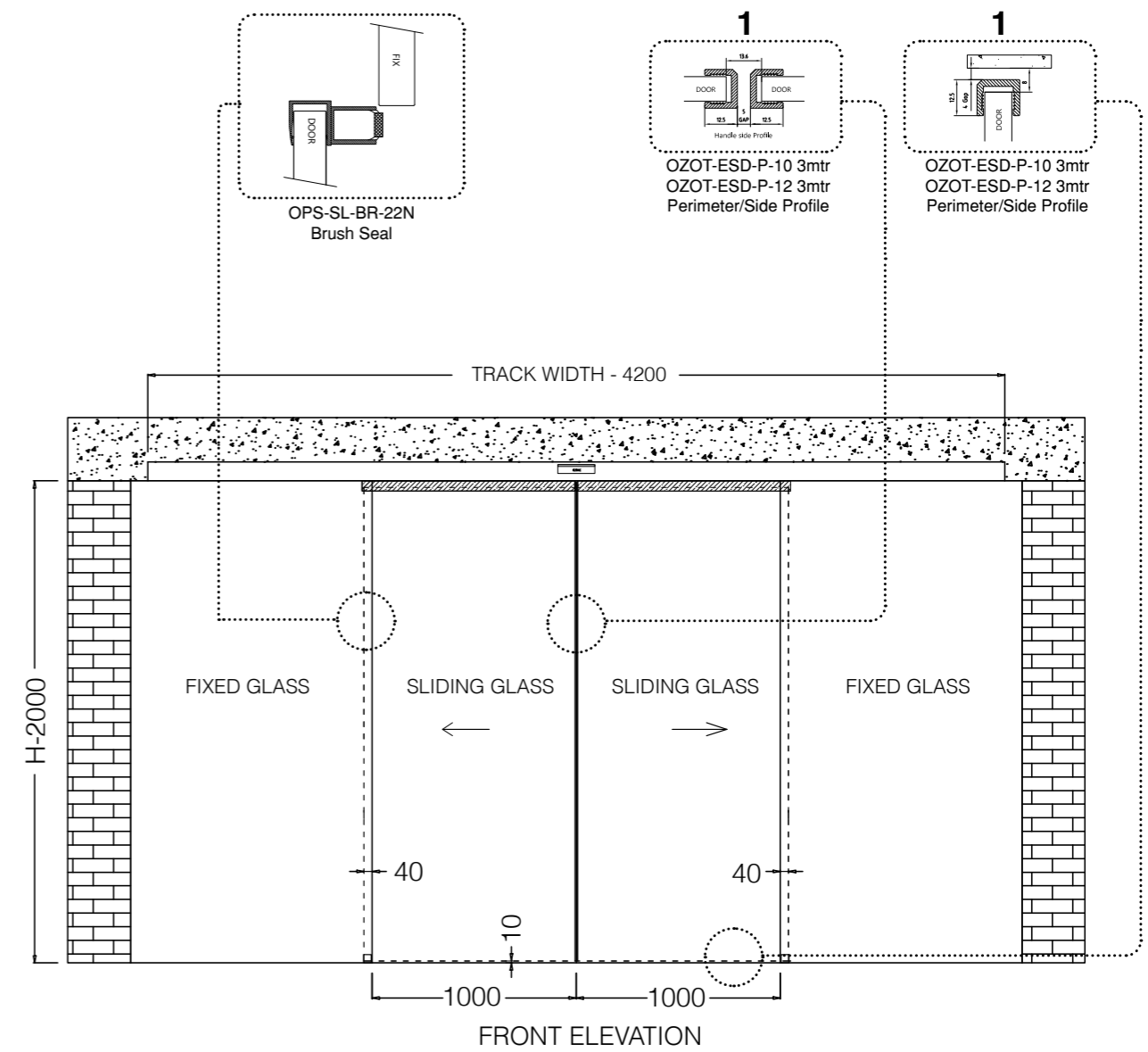

For 10 MM Glass Thickness				
S. No.	Code	Descriptions	Length	QTY.
1	OZOT-ESD-P-10 3mtr BM	Perimeter/Side Profile	3Mtr	3 Nos.
For 12 MM Glass Thickness				
S. No.	Code	Descriptions	Length	QTY.
1	OZOT-ESD-P-12 3mtr BM	Perimeter/Side Profile	3Mtr	3 Nos.

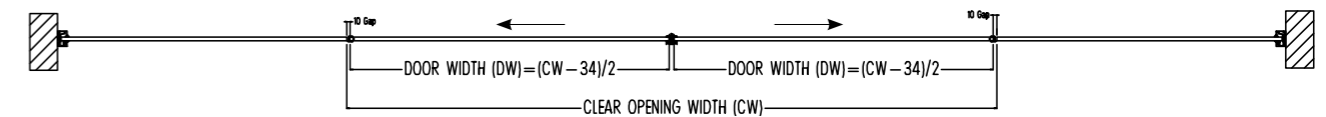

OUTLINER AUTO PRO



OZOM-111E-PLUS-N 4.2mtr
OZOM-111E-PLUS-N Single 2.4 mtr STD
 (For Single Door)
 Compact & Slim body | Intelligent Controller |
 Modular Design | Noiseless Functionality

Features:

- Engine case, height: 128mm
- Engine case cover height: 150mm
- Self learning micro computer processing controller
- Adjustable tensioner wheel
- 24V DC 65W brushless motor
- Digital adjustable parameters
- Controller with built-in remote control receiver
- In-built electromagnetic locking

Specifications:

- Single / Bi-parting sliding door system
- Suitable door weight : 100 Kg x 2
- Maximum door opening : 2mtr
- Adjustable parameters for opening speed, closing speed, opening buffer speed, closing buffer speed, opening buffer distance, closing buffer distance, opening time & opening force
- Integration possible with Microwave Sensor, Handwave Sensor, PIR Sensor, Digital Door Key, Finger Print Controller Wireless Push Button, Safety Beam, Remote Control, Push Buttons etc
- Warranty will be lapsed in absence of CVT.



OZOM-111P-PLUS 4.2mtr
OZOM-111P-PLUS 5.2mtr
OZOM-111P-PLUS 6.0mtr
 Compact & Slim body | Noiseless Functionality | Intel-
 ligent Controller | Modular Design

Features:

- Engine case, height: 90mm
- Self-learning micro-computer processing controller
- Slim type track
- 24V DC 65W brushless motor with built-in rectifier
- Adjustable parameters
- Engine case cover height: 155mm
- Controller with built-in remote control receiver
- Adjustable tensioner wheel
- Operating standard cycle for 5,00,000 cycles in-house tested

Specifications:

- Single/Bi-parting sliding door system
- Suitable door weight : 120Kg x 2
- Maximum door width : 2/2.5/3mtr
- Adjustable parameters for opening speed, door buffer distance, door buffer intensity, closing speed, closed buffer distance, closed buffer force, opening hours, & starting force
- Integration possible with Microwave Sensor, Handwave Sensor, PIR Sensor, Digital Door Key, Wireless Push Button, Safety Beam, Remote Control, Push Buttons, etc.
- Warranty will be lapsed in absence of CVT.

OUTLINER MOTION SENSOR

OZOM-AC-99

Microwave Sensor

High sensitivity, wide range eagle type sensors with least interface with industrial noise.

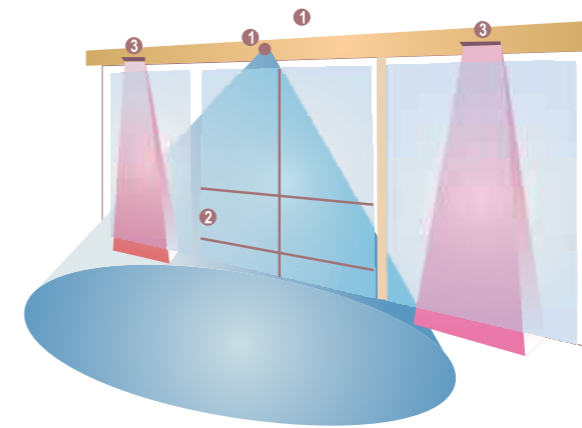

1. Microwave sensor, detects moving objects
2. Infrared safety beam, opens the door if someone comes in between door while closing
3. Infrared presence detector

Technical Specification

Technology	Microwave and Microprocessor
Transmitter frequency	24.125 Ghz
Transmitter radiated power	<20dBm EIRP
Transmitter power density	<5mW/cm ²
Detection mode	Motion
Minimum detection speed	5 cm/s (measure in the sensor axis)
Supply voltage	12V-24V AC+/-10%, 12V-30V DC
Mains frequency	50 to 60 Hz
Max. power consumption	<2W (VA)
Output	relay (free of potential change-over contact)
• Max. contact voltage	42V AC-60V DC
• Max. contact current	1A (resistive)
• Max. switching power	30W (DC)/60VA (AC)
Max. mounting height	3m
Protection degree	IP54
Temperature range	from- 20 C to +55 C

Specification are subject to change without prior notice



Avoid extreme vibration

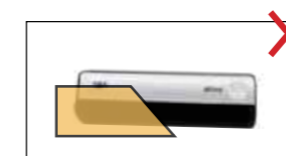

Do not cover the sensor



Avoid moving objects & light sources in the detection field

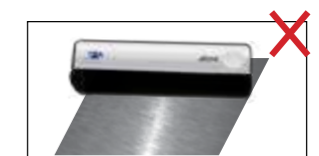

Avoid highly reflective objects in the infrared field

OUTLINER AUTO PRO

Microwave Sensor: High sensitivity, wide range eagle type sensors with least interface with industrial noise. Infrared Sensor for Active and presence detector.

Opening & safety sensor for automatic sliding doors

Other use of the device is outside the permitted purpose and can not be guaranteed by the manufacturer. The manufacturer cannot be held responsible for incorrect installations or inappropriate adjustments of the sensor.

OZOM-AC-11-ZS

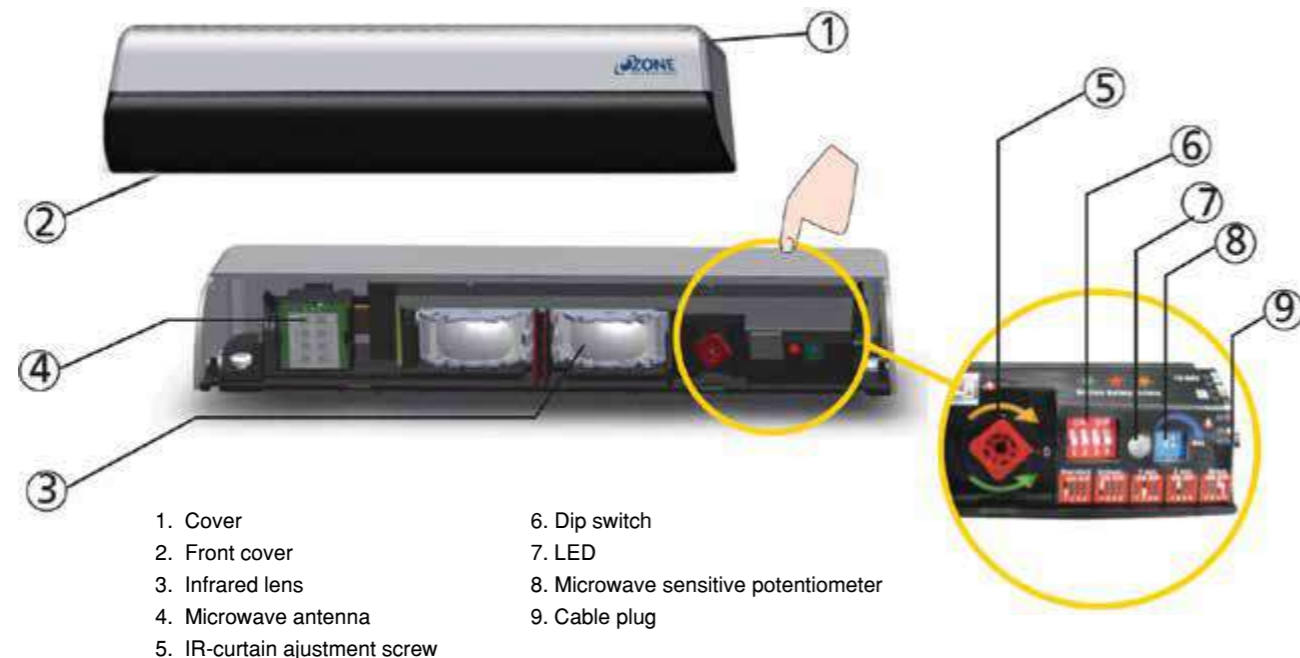

- 1. Cover
- 2. Front cover
- 3. Infrared lens
- 4. Microwave antenna
- 5. IR-curtain adjustment screw
- 6. Dip switch
- 7. LED
- 8. Microwave sensitive potentiometer
- 9. Cable plug

Technical Specification

Supply voltage:	12 V-24 V AC +/-10% ; 12 V-30 V DC 0%/+10%	
Power consumption:	< 3W	
Mounting height:	1.8m to 3m	
Temperature range:	-25°C to +55°C	
Degree of protection:	IP54	
Detection mode:	Motion Min. detection speed: 5cm/s	Presence Typical response time: <128ms (max. 500ms)
Technology:	Microwave doppler radar Transmitter frequency: 24.150 GHz Transmitter radiated power: <20 dBm EIRP Transmitter power density: <5 mW/cm ²	Active infrared with background analysis Spot diameter: 6cm (typ) Number of spots: 24 by curtain Number of curtains: 1
Angle:	From 15 to 45 vertical (adjustable)	From -5 to +8 (adjustable)
Output:	Relay (free of potential) Max. contact voltage: 42 V AC/DC Max. contact current: 1A (resistive) Max. switching power: 30W (DC)/60 VA (AC)	Relay (free of potential) Max. contact voltage: 42V AC/DC Max. contact current: 1A (resistive) Max. switching power: 30W (DC)/60 VA (AC)
Hold time output signal:	0.5s	0.5s

Specification are subject to change without prior notice

OUTLINER ACCESSORIES



OZOM-PR-11 1Mtr Zinc
OZOM-PR-11 1.5Mtr Zinc



OZOM-FG-22
Floor guides for framed doors with adjustable width (pair)



OZOM-WPB-22 Std. Std.
Wireless Push Button (Waterproof)



OZOM-FPC-11M STD
Finger Print Access Control



OZOM-HWS-11
Hand Wave Sensor



OZOM-11P-AC-11
Remote Control for Automatic Sliding Door



OZOM-SW-11M STD STD
Metallic wall mounting push button switch



OZOM-SB-11N (Single Barrier)
OZOM-SB-12 (Double Barrier)



OZOM-111E-PLUS-N
Remote Control



OZOM AC-66 PIR
Ceiling mounting PIR sensor



OZOM-111P-PLUS
Remote Control



OZOM-SW-11 STD STD
Large area push button for automatic doors



EAZY Partitioning Systems are quick to install, demountable profiled doors and partitions. These systems ensure elegance and transparency as per modern architectural trends. Slim extruded profiles give comprehensive systems for various layouts.

A large range of hardware and accessories derivatives complete the solution.

TECHNICAL DATA

Glass Type	Tempered Glass
Glass Thickness	10mm and 12mm
Max. Door Height	3000mm
Max. Partition Height	3000mm
Door Weight	45 - 100kg
Application	Door assembly with Over Panel and Sidelight
Material	Aluminium

Finishes



Aluminium Anodized



Black Matt

EAZY-11 SINGLE SWING DOOR

OZ-DP-PR-11 3mtr AN
Fixed Profile



NSK-780 STD SILVER x1 Nos.
Overhead Rack & Pinion Door Closer



NSK-ACC-780-PLATE STD Silver x1 Nos.
Plate for Mounting Door Closer on Glass



OZHN-DP1-CC Std Std x2 Nos.
Corner Cleat



OZHN-DP1-PS 10mm BL
OZHN-DP1-PS 12mm BL
Perimeter Seal



OZHN-DP1-3mtr AN
Door Profile



OZHN-DP1-GK 10mm BL
OZHN-DP1-GK 12mm BL
EPDM Gasket

OZHN-DP1-RP Std Mill x2 Nos.
Re-inforcement Plate



OGC-DH-1 STD AN x2 Nos.
Frame Front Face Mounting Hinge (Round)



OZ-DP 1/2-GDL STD AN x1 Nos.
Glass Door Lock with Lever Handle



TECHNICAL DATA

Glass Type	Tempered Glass
Glass Thickness	10mm and 12mm
Max. Door Height	3000mm
Max. Partition Height	3000mm
Door Weight	45 - 100kg
Application	Door assembly with Over Panel and Sidelight
Material	Aluminium

Finishes

Aluminium Anodized (AN) Black Matt (BM)



Functional Video

EAZY-22 DOUBLE SWING DOOR

OZ-DP-PR-11 3mtr AN
Fixed Profile



OZHN-DP1-CC Std x2 Nos.
Corner Cleat



NSK-980 SSS x2 Nos.
Door Closer



NSK-ACC-980-PLATE STD Silver x2 Nos.
Mounting Plate for Track Arm Door Closer



OZ-PGDH STD SSS x2 Nos.
Top Pivot Hinge



OZHN-DP1-PS 10mm BL
OZHN-DP1-PS 12mm BL
Perimeter Seal



OZHN-DP1-3mtr AN
Door Profile



OZHN-DP1-GK 10mm BL
OZHN-DP1-GK 12mm BL
EPDM Gasket

OZ-PGDH STD SSS x2 Nos.
Bottom Pivot Hinge



OGH-55 32x457mm WSS x2 Nos.
Glass Door Handle with Wooden Finish



TECHNICAL DATA

Glass Type	Tempered Glass
Glass Thickness	10mm and 12mm
Max. Door Height	3000mm
Max. Partition Height	3000mm
Door Weight	45 - 100kg
Application	Door assembly with Over Panel and Sidelight
Material	Aluminium

Finishes

Aluminium Anodized (AN) Black Matt (BM)



Functional Video

EAZY-33 WALL TO GLASS SINGLE SWING DOOR



TECHNICAL DATA

Glass Type	Tempered Glass
Glass Thickness	10mm and 12mm
Max. Door Height	3000mm
Max. Partition Height	3000mm
Door Weight	45 - 100kg
Application	Door assembly with Over Panel and Sidelight
Material	Aluminium



EAZY-44 SINGLE SWING DOOR

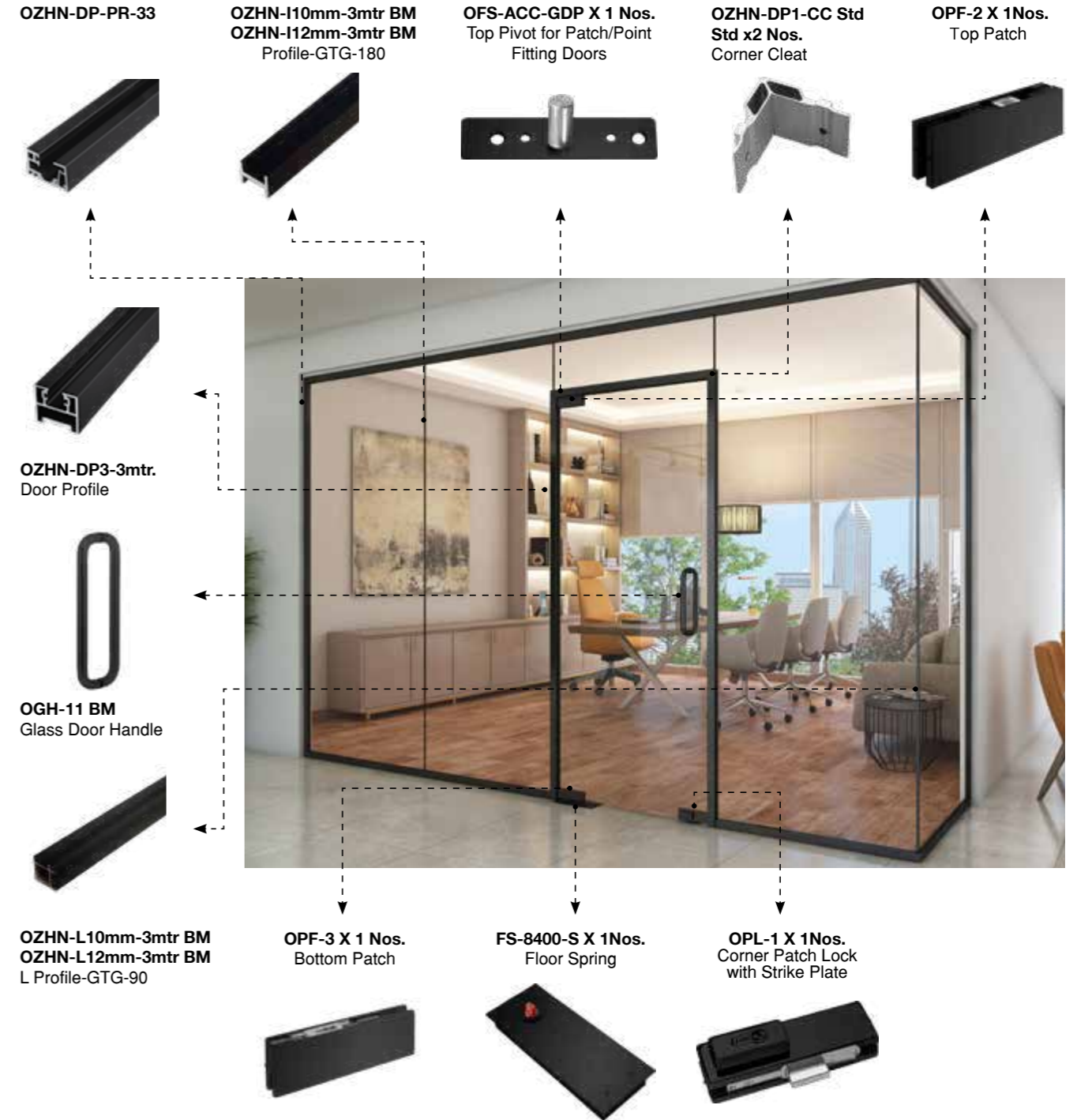

TECHNICAL DATA

Glass Type	Tempered Glass
Glass Thickness	10mm and 12mm
Max. Door Height	3000mm
Max. Partition Height	3000mm
Door Weight	45 - 100kg
Application	Door assembly with Over Panel and Sidelight
Material	Aluminium



EAZY-55 SINGLE SWING DOOR

OZHN-DP-PR-33 4mtr.



OPF-2 X 1Nos.
Top Patch



OFS-ACC-GDP X 1 Nos.
Top Pivot for Patch/Point
Fitting Doors



OZHN-DP1-CC Std Std
x2 Nos.
Corner Cleat

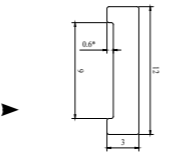
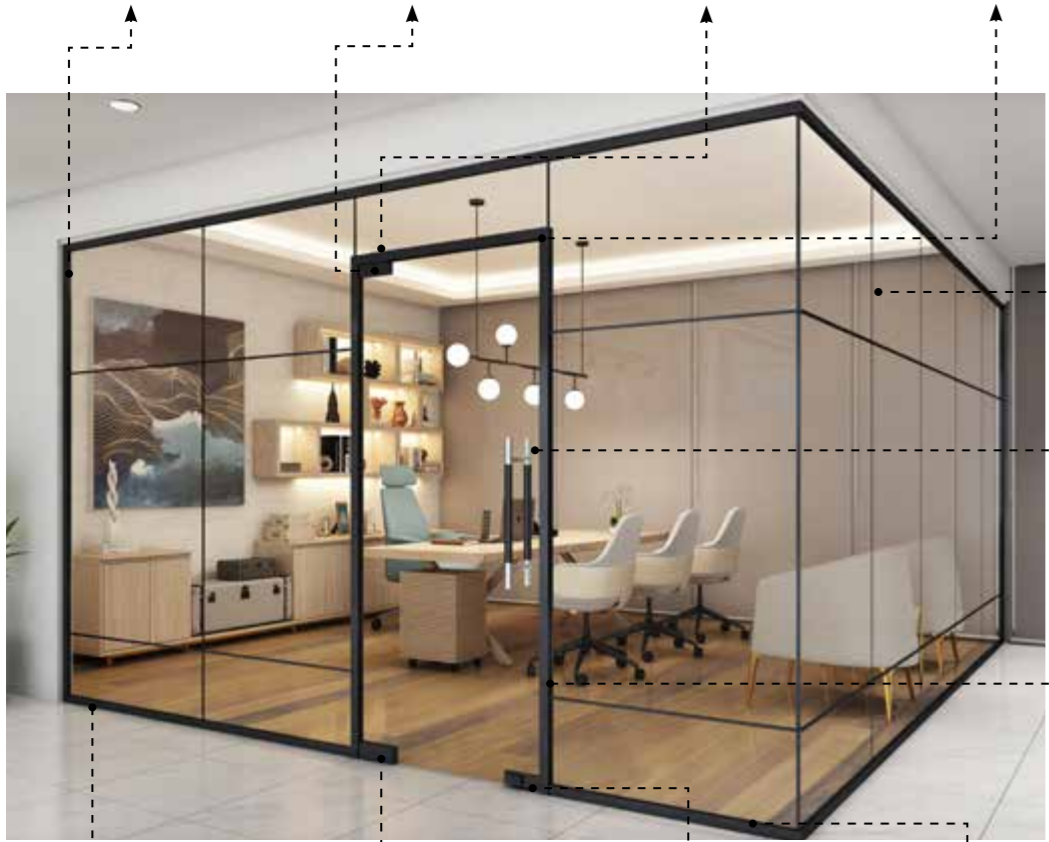

OZHN-DCOR-P 3
MTR. BM
Decorative Profile



OGH-55 x2 Nos.
H Type Handle



OZHN-DP3-3mtr.
Door Profile

OZHN-I10mm-3mtr BM
OZHN-I12mm-3mtr BM
Profile-GTG-180



OCFH-100 X 1 Nos.
The Original Self Closing
Patch Fitting



OPL-1 X 1Nos.
Corner Patch Lock
with Strike Plate



OZHN-L10mm-3mtr BM
OZHN-L12mm-3mtr BM
L Profile-GTG-90



TECHNICAL DATA

Glass Type	Tempered Glass
Glass Thickness	10mm and 12mm
Max. Door Height	3000mm
Max. Partition Height	3000mm
Door Weight	45 - 100kg
Application	Door assembly with Over Panel and Sidelight
Material	Aluminium

Finishes

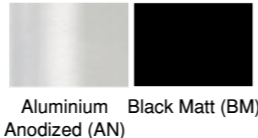

EAZY-66 SINGLE SWING DOOR

OZHN-DP-PR-33 4mtr.



OFS-ACC-GDP X 1 Nos.
Top Pivot for Patch/Point
Fitting Doors



ODR-1 X 1Nos.
Top Rail



OZHN-I10mm-3mtr BM
OZHN-I12mm-3mtr BM
Profile-GTG-180



OZHN-DP1-CC Std
Std x2 Nos.
Corner Cleat



OGH-55 32x457mm
X 1 Nos.
Handle

OZHN-L10mm-3mtr.
X 1 Nos.



ODR-2 X 1 Nos.
Bottom Rail



OZHN-DP3 3mtr
Door Profile



TECHNICAL DATA

Glass Type	Tempered Glass
Glass Thickness	10mm and 12mm
Max. Door Height	3000mm
Max. Partition Height	3000mm
Door Weight	45 - 100kg
Application	Door assembly with Over Panel and Sidelight
Material	Aluminium

Finishes

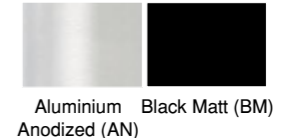

GLASS-TO-GLASS PROFILES

Available in Black Matt and Aluminium Anodized



OZHN-DP1-3mtr AN

OZHN-DP1-3mtr ABM
Door Profile



OZ-DP-PR-11 3mtr AN

OZ-DP-PR-11 3mtr BM
Fixed Profile



OZHN-DP1-PS 10mm BL
OZHN-DP1-PS 12mm BL
Perimeter Seal



OZHN-DP2-PS 10mm BL
OZHN-DP2-PS 12mm BL
Perimeter Seal



OZHN-DP1-GK 10mm BL
EPDM Gasket



OZHN-DP1-GK-12mm STD
EPDM Gasket



OZHN-DP1-RP Std Mill
Reinforcement Plate
without Hole



OZHN-DP1-CC Std Std
Corner Cleat

GLASS-TO-WALL PROFILES

Available in Black Matt and Aluminium Anodized



OZHN-DP2 3mtr AN

OZHN-DP2 3mtr ABM
Door Profile with Back Plate &
Metal Gasket



OZHN-DP2 3mtr AN

OZHN-DP2 3mtr ABM
Door Profile with Back Plate &
Metal Gasket



OZHN-DP2 3mtr AN

OZHN-DP2 3mtr ABM
Door Profile with Back Plate &
Metal Gasket



OZHN-DP2-RP Std Mill
Re-inforcement Plate without Hole



OZHN-DP2-CC1 Std Mill
Corner Cleat



OZHN-DP2-CC2 Std Mill
Corner Cleat

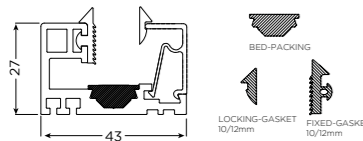

Fixed Profile
OZHN-DP-PR-33 4mtr ABM
OZHN-DP-PR-33 4mtr AN

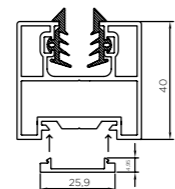

Wall/Transom-Door Profile
OZHN-DP3 3mtr ABM
OZHN-DP3 3mtr AN

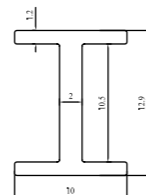

I Profile-GTG-180
OZHN-I10mm-3mtr BM
OZHN-I10mm-3mtr AN

GLASS-TO-GLASS PROFILES

Available in Black Matt and Aluminium Anodized

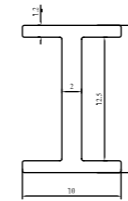

I Profile-GTG-180
OZHN-I12mm-3mtr BM
OZHN-I12mm-3mtr AN

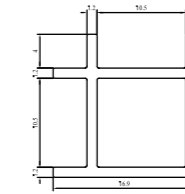

L Profile-GTG-90
OZHN-L10mm-3mtr BM
OZHN-L10mm-3mtr AN

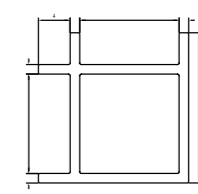

L Profile-GTG-90
OZHN-L12mm-3mtr BM
OZHN-L12mm-3mtr AN

HANA EAZY-11/22/33

Available in Black Matt, Aluminium Anodized and SSS



OGC-DH-1 STD AN

OGC-DH-1 STD BM
Frame Front Face Mounting
Hinge (Round)



OZ-PGDH STD SSS

OZ-PGDH STD BM
Top/Bottom Pivot Hinge



OGC-DH-2 STD SSS

OGC-DH-2 STD BM
Frame Rebate Mounting
Hinge (Square)



OZ-DP 1/2- GDL STD AN

OZ-DP 1/2- GDL STD BM
Glass Door Lock with Lever
Handle



OZ-PGDH STD SSS

OZ-PGDH STD BM
Top/Bottom Pivot Hinge



OGC-DH-2 STD SSS

OGC-DH-2 STD BM
Frame Rebate Mounting Hinge
(Square)



OZ-DP1/2-SB STD AN

OZ-DP1/2-SB STD BM
Strike Box for OZ-DP1/2-
GDL STD BM



OZ-DP1/2-SP STD
Strike Plate for OZ-DP1/2-
GDL STD AN



OZ-FGL-BL-G2G Black
Fingerprint Digital Glass Door
Lock with 4 in 1 Access

GLASS-TO-GLASS PROFILES

Available in Black Matt, Aluminium Anodized and SSS

EAZY-44/55/66

Available in Black Matt, Aluminium Anodized and SSS



OGH-55 32x457mm BMSS
Glass Door Handle with Wooden Finish



NSK-780 STD SILVER
NSK-780 STD BM
Overhead Rack & Pinion Door Closer with Scissor/Cross Arm



NSK-ACC-780-PLATE STD SILVER
OZ-DP-PR-11 3mtr BM
Fixed Profile



OPF-2 X 1Nos.
Top Patch

OPF-2 X 1Nos.



OPF-3 X 1 Nos.
Bottom Patch

OPF-3 X 1 Nos.



OFS-ACC-GDP X 1 Nos.
Top Pivot for Patch/Point Fitting Doors



ONSK-980 TA. BM
Overhead Rack & Pinion Door Closer with Track Arm

NSK-980 TA. SSS



NSK-ACC-980-PLATE STD SILVER
NSK-ACC-980-PLATE STD BM
Mounting Plate for Track Arm Door Closer



OZDL-23 PCF- G2G STD
Fingerprint Digital Glass Door Lock with 4 in 1 Access Modes



OGH-11 BM
Glass Door Handle

OGH-11 SSS



OPL-1 X 1Nos.
Corner Patch Lock with Strike Plate

OPL-1 X 1Nos.



FS-8400-S X 1Nos.
Floor Spring

FS-8400-S X 1Nos.



OGH-55 32x457mm WSS
Glass Door Handle with Wooden Finish



OGHL-55-25x1340 SSS
Glass Door Handle with Locking Function



OGH-55
H Type Handle



OCFH-100 X 1 Nos.
The Original SELF-CLOSING Patch Fitting

OCFH-100 X 1 Nos.



ODR-1 X 1Nos.
Top Rail



ODR-2 X 1Nos.
Bottom rail

EAZY SL-11 MINIMAL SLIDING DOOR SYSTEM

Glass Thickness: 8mm

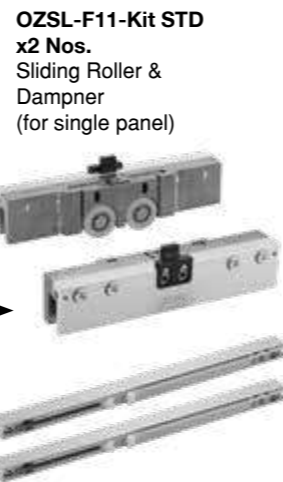
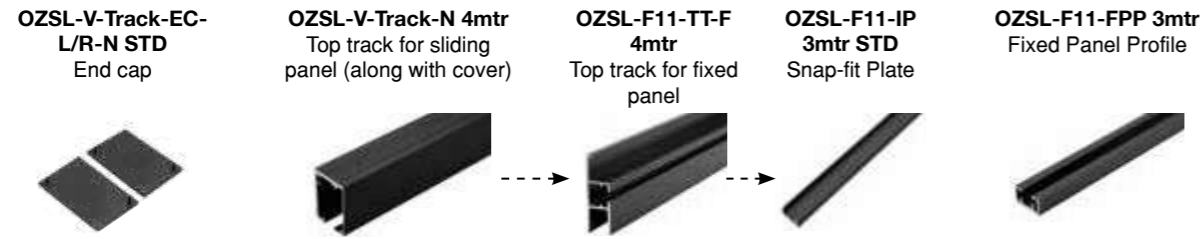

OZSL-F11-FG STD
x2 Nos.
Floor Guide



OZ-SL-HN-90 STD
x2 Nos.
Sliding Door Handle



TECHNICAL DATA

Glass Type	Tempered Glass
Glass Thickness	8mm
Max. Door Height	2400mm
Max. Door Weight	80kg
Track Length	4000mm
Application	Interior
Material	Aluminium
Available in	One Panel Sliding Door Two Panels(Bi-parting) Sliding Door

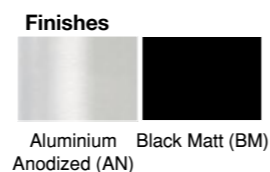

Note: The number of the profiles will change as per the length of the door and according to the site measurement.

MINIMAL SLIDING DOOR SYSTEM

Available in Black Matt and Aluminium Anodized



OZSL-F11-TT-F 4mtr BM
Top track for fixed panel



OZSL-V-Track-N 4mtr BM
Top track for sliding panel
(along with cover)

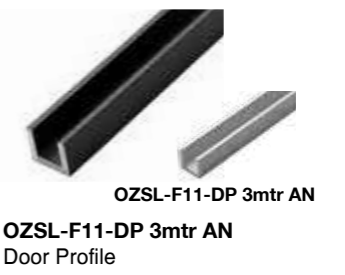

OZSL-F11-DP 3mtr AN
Door Profile



OZSL-F11-FPP 3mtr BM
Fixed Panel Profile

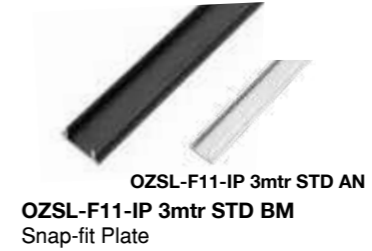

OZSL-F11-IP 3mtr STD BM
Snap-fit Plate

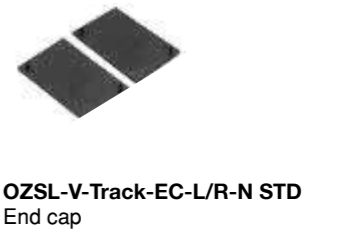

OZSL-V-Track-EC-L/R-N STD
End cap



OZ-SL-HN-80 STD BM
Fixed Panel Profile



OZ-SL-HN-90 STD BM
Sliding Glass Door Handle

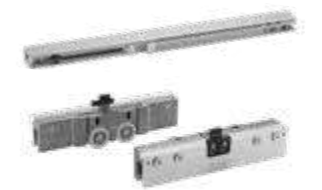

OZSL-F11-Kit STD
Sliding Roller & Dampner
(for single panel)



OZSL-V-Clip-N Std Std
V Clip

EAZY SL-22 SELF CLOSING SLIDING DOOR SYSTEM

Glass Thickness: 10-12mm



OZSL-V-PUL-RN/LN
x1 Nos.
Pull Back Pulley



OZSL-V-A3L-N STD
OZSL-V-A3R-N STD
x1 Nos.
Stopper



OZSL-F11-Kit STD x1 Nos.
Sliding Roller & Dampner
(for single panel)

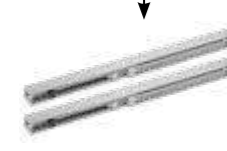
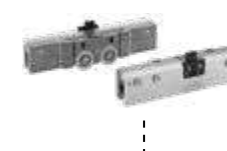

OZSL-V-FG-N STD
x1 Nos.
Floor Guide



OZ-SL-HN-50 STD
x1 Nos.
Sliding Door Handle



OZ-DP-PR-11 3mtr
Fixed Profile



TECHNICAL DATA

Glass Type	Tempered Glass
Glass Thickness	10mm and 12mm
Max. Door Height	2400mm
Max. Partition Height	3000mm
Max. Door Weight	80kg
Track Length	3000mm
Application	Door assembly with Over Panel and Sidelight
Material	Aluminium

Finishes

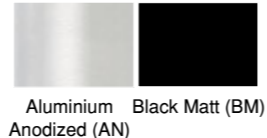

SELF CLOSING SLIDING DOOR SYSTEM

Available in Black Matt and Aluminium Anodized



OZSL-V-Track-EC-L/R-N
Track End Cap



OZSL-V-A6-CVR-EC-N
Cover End Cap



OZSL-V-PUL-RN/LN
Pull Back Pulley



OZSL-F11-Kit STD
Sliding Roller & Dampner (for single panel)

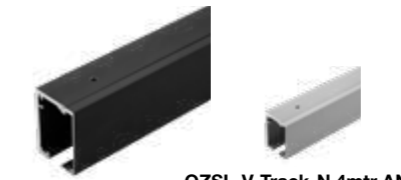

OZSL-V-Track-N 3mtr BM
OZSL-V-Track-N 4mtr BM
Top Track for Sliding Panel
(along with cover)



OZSL-V-A6-CVR-N 3mtr AN
OZSL-V-A6-CVR-N 4mtr AN
OZSL-V-A6-CVR-N 3mtr BM
OZSL-V-A6-CVR-N 4mtr BM
Track Cover



OZSL-V-A6-CVR-N 3mtr AN
OZSL-V-A6-CVR-N 4mtr AN
OZSL-V-FG-N STD BM
Floor Guide



OZSL-V-FDM-LN Std SS
OZSL-V-FDM-RN Std SS
Floor Dampner



OZSL-V-A6-N
Glass to Track Fixer



OZ-DP-PR-11 3mtr AN
OZ-DP-PR-11 3mtr AN
Fixed Profile



OZSL-V-A3R-N STD
OZSL-V-A3L-N STD
Stopper



SL-HN-50 STD SSS
Sliding Door Handle

EAZY SL-33 SOFT CLOSING SLIDING DOOR SYSTEM

Glass Thickness: 10-12mm



OZ-DP-PR-11 3mtr
Fixed Profile



OZSL-V-A3R-N STD
OZSL-V-A3L-N STD
Stopper



OSDL-11LR-K2N STD
Sliding Door Lock



OZSL-F11-Kit STD
Sliding Roller & Dampner
(for single panel)

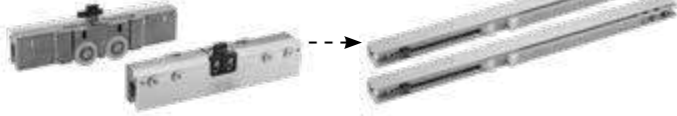

OZSL-V-FG-N STD
Floor Guide



TECHNICAL DATA

Glass Type	Tempered Glass
Glass Thickness	10mm and 12mm
Max. Door Height	2400mm
Max. Partition Height	3000mm
Max. Door Weight	80kg
Track Length	3000mm
Application	Door assembly with Over Panel and Sidelight
Material	Aluminium

Finishes

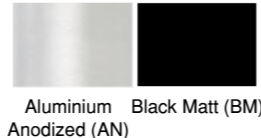

Note: The number of the profiles will change as per the length of the door and according to the site measurement.

SOFT CLOSING SLIDING DOOR SYSTEM

Available in Black Matt and Aluminium Anodized



CONCEPT-A STANDARD SLIDING DOOR SYSTEM

OZ-SL-44-A3 STD WHITE Stopper

SL-44-A6 STD Glass to Track Fixer with Counter Sunk

OZ-SL-44-A2 STD SSS Roller

OZ-SL-44-B1 Track 4M STD AN Track

OZ-FGL-BL-G2G-BLACK App Connected Digital Lock for Sliding Door

OZ-DP-PR-11 3mtr Fixed Profile

OZ-SL-HN-50 STD SSS Door Handle

OSL-33G Floor Guide

Available Range:	SL-44-A1	SL-44-A2	OSL-ED-44-A1	OSL-ED-44-A2
Weight Carrying Capacity	40 Kg	80 Kg	60 Kg	90 Kg

TECHNICAL DATA

Glass Type	Tempered Glass
Glass Thickness	10mm and 12mm
Max. Door Height	2400mm
Max. Partition Height	3000mm
Max. Door Weight	40kg - 90kg
Application	Door assembly with Over Panel and Sidelight
Material	Aluminium

Refer to the Ozone glass hardware range for more choices

Finishes

Aluminium Anodized (AN) | Black Matt (BM)

Functional Video

CONCEPT-A STANDARD SLIDING DOOR SYSTEM

Available in Black Matt and Aluminium Anodized

OZ-SL-44-A2 KIT STD SSS

OZ-SL-44-A2 KIT STD BM
Kit Includes: 02 pcs Roller, 02 pcs Stopper and 01 pc Floor Guide

OZ-SL-44-A2 KIT STD BM
Kit Includes: 02 pcs Roller, 02 pcs Stopper and 01 pc Floor Guide

OZ-SL-44-A2 KIT STD BM
Kit Includes: 02 pcs Roller, 02 pcs Stopper and 01 pc Floor Guide

OZ-SL-44-A6 STD SSS
Glass to Track Fixer with Counter Sunk

OZ-DP-PR-11 3mtr AN

OZ-DP-PR-11 3mtr BM
Fixed Profile

OZ-SL-44-B1 Track 4M STD AN

OZ-SL-44-B1 Track 4M STD BM
Track



EAZY SHOWER -11 FRAMED SHOWER ENCLOSURE



OZSL-F22-180 R 3X2mtr (WXH) CP/BM

TECHNICAL DATA

Glass Type	Tempered Glass
Glass Thickness	8mm
Max. Door Height	2000mm
Max. Door Weight	45kg
Track Length	3000mm
Application	Shower Enclosure
Material	Aluminium
Standard Finishes	CP & BM

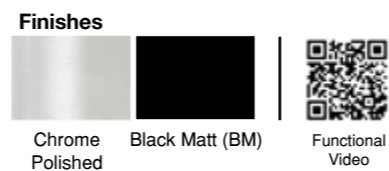

EAZY SHOWER -11 FRAMED SHOWER ENCLOSURE

Available in Black Matt and Aluminium Anodized



EAZY SHOWER -22 FRAMED SHOWER ENCLOSURE



OZSL-F22-90 R 2X2X2.5mtr (DXWXH) CP/BM

TECHNICAL DATA

Glass Type	Tempered Glass
Glass Thickness	8mm
Max. Door Height	2000mm
Max. Door Weight	45kg
Track Length	3000mm
Application	Shower Enclosure
Material	Aluminium
Standard Finishes	CP & BM

Finishes



EAZY SHOWER -22 FRAMED SHOWER ENCLOSURE

Available in Black Matt and Aluminium Anodized





EAZY-11
SINGLE SWING DOOR



EAZY-22
DOUBLE SWING DOOR



EAZY-33
WALL-TO-GLASS SINGLE SWING DOOR



EAZY-44
SINGLE SWING DOOR



EAZY-55
SINGLE SWING DOOR



EAZY-66
SINGLE SWING DOOR



EAZY-11/22/33/44/55/66
PROFILE & ACCESSORY DETAILS



EAZY-11/22/33/44/55/66
HARDWARE



EAZY SL-11
MINIMAL SLIDING DOOR SYSTEM



EAZY SL-22
SELF-CLOSING SLIDING DOOR SYSTEM



EAZY SL-33
SOFT-CLOSING SLIDING DOOR SYSTEM



CONCEPT-A
STANDARD SLIDING DOOR SYSTEM



EAZY SL-11/22/33 & CONCEPT-A
HARDWARE



EAZY SHOWER-11
FRAMED SHOWER ENCLOSURE



EAZY SHOWER-22
FRAMED SHOWER ENCLOSURE



STAND-OFF SYSTEMS



Available Finish:



GRADE SS 304



SERIES: OZRSO-11
Available Sizes

Product Code	Sizes	Thickness
OZRSO-11-38X50	Dia 38x50 (L)	8-19mm
OZRSO11-38X30	Dia 38x30 (L)	8-13.52mm



SERIES: OZRSO-33
Available Sizes

Product Code	Sizes	Thickness
OZRSO-33-50X50	Dia 50x50 (L)	8-19mm
OZRSO-33-50X30	Dia 50x30 (L)	8-13.52mm



SERIES: OZRSO-66
Available Sizes

Product Code	Sizes	Thickness
OZRSO-66-50X50	Dia 50x50 (L)	8-19mm
OZRSO-66-50X30	Dia 50x30 (L)	8-13.52mm



SERIES: OZRSO-55
Available Sizes

Product Code	Sizes	Thickness
OZRSO-55-38X50	Dia 38x50 (L)	8-19mm
OZRSO-55-38X30	Dia 38x30 (L)	8-13.52mm

GLASS RAILING SOLUTIONS

Ozone offers a wide range of Architectural & Glass Railing Solution i.e. Standoff, Clear Line, Spigot, Mini Baluster, and Standard Balusters systems. Every product is quality tested across multiple parameters for general structure integrity and safety and then central statically located ware housing, logistics and distribution facilities with our wide network of over 1500 best in class certified dealer outlets. We take care of the safety parameters and deliver safe railing with best Machinery, Technology, Distribution Network, Knowledge Base, Work Force and commendable leadership. Explore the range yourself to review the latest additions in the range.

Note: Customizations are also available for the different type of projects and utilities as per architect and client requirement like.

SPIGOT SYSTEMS



Available Finish:



OZRSP-250X50-SC2
Available Sizes in mm
250mm(H) x 50mm (W)



OZRSP-150X40
Available Sizes in mm
150mm(H) x 40mm (W)



OZRSP-250X50-SC3
Available Sizes in mm
250mm(H) x 50mm (W)



OZRSP-200X50
Available Sizes in mm
200mm(H) x 50mm (W)



OZRSP-250X50-SC1
Available Sizes in mm
250mm(H) x 50mm (W)



OZRSP-180X50-A
Available Sizes in mm
180mm(H) x 50mm (dia)

Note: This product does not required Glass Hole



OZRSP-180X50-B
Available Sizes in mm
180mm(H) x 50mm (W)

Note: This product does not require Glass Hole

MINI BALUSTER

Available Finish:



GRADE
SS 304



OZRSL-11-DGH
Available Sizes in mm
40mmx10mm Solid Flat
Round base plate with 2Nos. Holes



OZRSL-22-DGH
Available Sizes in mm
40mmx10mm Solid Flat
Round base plate with 2Nos. Holes



OZRSL-44-DGH
Available Sizes in mm
40mmx20mmx1.5mm thick
Round base plate with 2Nos. Holes



OZRSL-55-DGH
Available Sizes in mm
dia38mmx1.5mm thick
Round base plate with 2Nos. Holes



OZRSL-66-DGH
Available Sizes in mm
10mm Thick Flat

CLEAR LINE SYSTEMS

Available Finish: Anodized



OZRCL-125X75
Available Sizes in mm
125(H) x 75(W)

Aluminum 6063 Grade
Standard Length: 3Mtr.



OZRCL-125X57
Available Sizes in mm
125(H) x 57(W)

Aluminum 6063 Grade
Standard Length: 3Mtr.



OZRCL-100X50
Available Sizes in mm
100(H) x 50(W)

Aluminum 6063 Grade
Standard Length: 3Mtr.



OZRCL-75x50
Available Sizes in mm
75(H) x 50(W)

Aluminum 6063 Grade
Standard Length: 3Mtr.



OZRCL-120X45
Available Sizes in mm
120(H) x 45(W)

Aluminum 6063 Grade
Standard Length: 3Mtr.

Notes:

- Bottom Aluminium profile comes with Nylon 'L' block, wedge, outside EPDM & inside EPDM only.
- Top slotted profile & EPDM should be order extra as per product fitment and client requirement.
- Faster & glass is not included in this product series.

STAINLESS STEEL TOP HANDRAIL PROFILE



GRADE
SS 304

Available Finish
SSS

- OZRAC-UTB-42**
Dia 42mm x 1.5mm thick with 24mm x 24mm Groove Standard Length: 3Mtr.
- OZRAC-UTB-40X40**
40mm x 40mm with 24mm x 24mm Groove Standard Length: 3Mtr.
- OZRAC-UTB-60X40**
60mm x 40mm with 24mm x 24mm Groove Standard Length: 3Mtr.
- OZRAC-UC-12-13.5**
19 x 24 x 1.5mm thick Standard Length: 2.4Mtr.

ALUMINIUM HANDRAIL PROFILE



- OZRAC-UTB-40X40-AL**
40mm x 40mm x 1.5mm thick Groove Pipe: 28MM(H) 20MM(W) Aluminium 6063 Grade Anodized Finish Standard Length: 3Mtr.
- OZRAC-UTB-50-AL**
Dia 50mm x 1.6mm thick Groove Pipe: 28MM(H) 20MM(W) Aluminium 6063 Grade Anodized Finish Standard Length: 3Mtr.

EDPM PROFILES

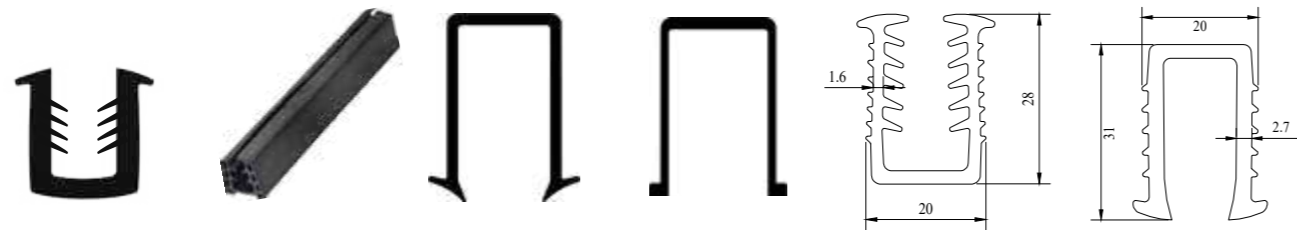

- OZRAC-GKT-11**
24mmX 22.5mm (Flexible) Black Color For 12mm to 13.52mm thick glass
- OZRAC-GKT-22**
24.5mmX 25mm (Flexible) Black Color For 10mm thick glass
- OZRAC-GKT-33**
16mmX 25mm (Flexible) Black Color For OZRAC-UC-12-13.5 (12mm thick glass)
- OZRAC-GKT-44**
16mmX 25mm (Flexible) Black Color For OZRAC-UC-12-13.5 (13.5mm thick glass)
- OZRAC-GKT-88**
For 10-12mm thick glass Suitable for Aluminium Saloted Handrail
- OZRAC-GKT-55**
For 13.52mm thick glass Suitable for Aluminium Saloted Handrail

WALL TO HANDRAIL CONNECTOR



GRADE
SS 304

Available Finish: SSS

- OZRAC-11-WH**
Dia 22mm & 16mm (Rod) For 50MM Dia Pipe
- OZRAC-22-WH**
Dia 32mm (Solid Rod) For 50MM Dia Pipe
- OZRAC-33-WH**
Dia 16mm (Solid Rod) For 50MM Dia Pipe
- OZRAC-44-WH**
Casted wall to handrail connector For round handrail
- OZRAC-55-WH**
Dia 20mmx20mm (Solid Rod) For square handrail

GLASS TO HANDRAIL CONNECTOR



GRADE
SS 304

Available Finish: SSS

- OZRAC-11-GH**
Dia 22mm & 16mm (Rod) For 50MM Dia Pipe
- OZRAC-22-GH**
Dia 20mm (Solid Rod) For 50MM Dia Pipe
- OZRAC-33-GH**
Dia 16mm (Solid Rod) For 50MM Dia Pipe
- OZRAC-44-GH**
Casted glass to handrail connector For round handrail
- OZRAC-55-GH**
Dia 20mmx20mm (Solid Rod) For square handrail

TOP HANDRAIL PROFILE



- OZRAC-TB-50**
Dia 50mm & 1.5mm thick Standard Length: 3Mtr.
- OZRAC-TB-42**
Dia 42mm & 1.5mm thick Standard Length: 3Mtr.

(MIDRAIL)



- OZRAC-TB-12**
Dia 12mm & 1.5mm thick Standard Length: 3Mtr.

GRADE
SS 304

Available Finish: SSS



- OZRAC-TB-40x40**
40mmx40x40x1.5mm thick Standard Length: 3Mtr.

ELBOW



- OZRAC-EB-50A**
For 50mm dia Weld joint



- OZRAC-EB-50B**
For 50mm dia Weld joint



- OZRAC-EB-50C**
For 50mm dia Adjustable Push Fit joint



- OZRAC-EB-50D**
For 50mm dia Adjustable Push Fit joint

GRADE
SS 304

Available Finish: SSS



- OZRAC-EB-42A**
For dia 42mm pipe Push Fit joint



- OZRAC-EB-12A**
For dia 12mm pipe Weld joint



- OZRAC-EB-40X40B**
For 40x40mm tube Push fit joint



- OZRAC-EB-60X40B**
For 60x40mm tube Push fit joint



- OZRAC-EB-12B**
For dia 12mm pipe Adjustable push fit joint



- OZRAC-EB-40X40A**
For 40X40mm tube Adjustable push fit joint



- OZRAC-EB-60X40A**
For 60X40mm tube Adjustable push fit joint



- OZRAC-EB-50E**
For 50.8mm dia pipe



- OZRAC-EB-50F**
For 50.8mm dia pipe Adjustable push fit joint



- OZRAC-JO-50A**
For dia 50X1.5mm thick pipe



- OZRAC-JO-42**
For dia 42X1.5mm thick pipe



- OZRAC-JO-40X40**
For 40X40X1.5mm thick tube

ELBOW



OZRAC-JO-60X40
For 60X40X1.5mm thick tube



OZRAC-JO-12A
For dia 12X1.5mm thick pipe

GRADE SS 304

Available Finish: SSS

WALL END PLATE



OZRAC-WC-50A
Wall End Cap
For dia 50mm pipe



OZRAC-WC-42
Wall End Cap
For dia 42X1.5mm pipe



OZRAC-WC-40X40
Wall End Cap
For 40X40X1.5mm thick tube



OZRAC-WC-60X40
Wall End Cap
For 60X40X1.5mm thick tube

GRADE SS 304

Available Finish: SSS

GLASS HOLDER CLAMP



OZRAC-GC-B1
Glass Clamp (Big)
For flat surface & 10mm to 12mm thick glass



OZRAC-GC-B2
Square edge glass clamp (Big)
For flat surface & 10mm to 12mm thick glass



OZRAC-GC-B5
Glass clamp (Big)
For dia 50mm pipe & 10mm to 12mm thick glass



OZRAC-GC-B6
Square edge glass clamp (Big)
For dia 50mm pipe & 10mm to 12mm thick glass

GRADE SS 304

Available Finish: SSS

END CAP



OZRAC-EC-50A
For dia 50mmX1.5mm thick pipe
Push fit end cap



OZRAC-EC-42
For dia 42mmX1.5mm thick pipe
Push fit end cap



OZRAC-EC-60X40
For 60mmX40mmX1.5mm tube
Push fit end cap



OZRAC-EC-12A
For dia 12mmX1.5mm thick pipe
Push fit end cap



OZRAC-EC-40X40
For 40X40X1.5mm tube
Push fit end cap

GRADE SS 304

Available Finish: SSS

ELBOW



OZRAC-EB-40X40B AL AN
Elbow 90 for 40x40mm Aluminium Square Salotted pipe.



OZRAC-EB-50 AL AN
Elbow for Dia 50 mm aluminium Salotted hand rail.

Aluminium Grade: 6063
Available Finish: ANODIZED

JOINER



OZRAC-JO-40X40 AL AN
Pipe to pipe joiner 180 for 40x40mm Aluminium Square Salotted pipe.



OZRAC-JO-50 AL AN
Pipe to pipe joiner 180 for Dia 50mm Aluminium Salotted pipe.

WALL CAP



OZRAC-WC-50 AL AN
Wall mounted End Cap for Dia 50mm Aluminium Salotted pipe.



OZRAC-WC-40X40 AL AN
Wall mounted End Cap for 40x40mm Aluminium Square Salotted pipe.

Notes:

- Anchor fastener included with product is as per general usages only.
- Base Concrete should be M20 or M25 grade for fixing fastener.
- Mention glass thickness are for indicative only.
- Refer to Architect or structure consultant for specific glass & fastner specification.

OZRST-11 SERIES



OZRST-11-3R
Dia 50mmX1.5mm
Round base plate with
3Nos. holes
For mid rail dia 12mm &
handrail dia 50mm



OZRST-11-GH
Dia 50mmX1.5mm
Round base plate with
3Nos. holes
For 8 to 12mm thick glass &
handrail dia 50mm



OZRST-11-DGH
Dia 50mmX1.5mm
Round base plate with
3Nos. holes
For 8 to 12mm thick glass
& handrail dia 50mm



OZRST-11-GC1
Dia 50mmX1.5mm
Round base plate with
3Nos. holes
For 10mm to 12mm thick
glass & handrail dia 50mm



OZRST-11-GC2
Dia 50mmX1.5mm
Round base plate with
3Nos. holes
For 10mm to 12mm thick
glass & handrail dia 50mm

GRADE
SS 304

Available Finish: SSS

OZRST-33 SERIES



OZRST-33-3R
Dia 38mmX1.5mm
Round base plate with
3Nos. holes
For mid rail dia 12mm &
handrail dia 50mm



OZRST-33-GH
Dia 38mmX1.5mm
Round base plate with
3Nos. holes
For 8 to 12mm thick glass &
handrail dia 50mm

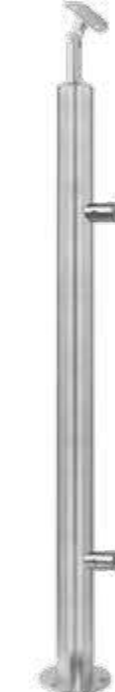

OZRST-33-DGH
Dia 38mmX1.5mm
Round base plate with
3Nos. holes
For 8 to 12mm thick glass
& handrail dia 50mm



OZRST-33-GC1
Dia 38mmX1.5mm
Round base plate with
3Nos. holes
For 10 to 12mm thick glass &
handrail dia 50mm



OZRST-33-GC2
Dia 38mmX1.5mm
Round base plate with
3Nos. holes
For 10 to 12mm thick glass
& handrail dia 50mm

GRADE
SS 304

Available Finish: SSS

OZRST-22 SERIES



OZRST-22-3R
Dia 50mmX1.5mm
Round base plate with
3Nos. holes
For mid rail dia 12mm
& handrail dia 50mm



OZRST-22-GH
Dia 50mmX1.5mm
Round base plate with
3Nos. holes
For 8 to 12mm thick Glass
& hand rail dia 50mm



OZRST-22-DGH
Dia 50mmX1.5mm
Round base plate with
3Nos. holes
For 8 to 12mm thick glass
& handrail dia 50mm



OZRST-22-GC1
Dia 50mmX1.5mm
Round base plate with
3Nos. holes
For 10 to 12mm thick glass
& handrail dia 50mm



OZRST-22-GC2
Dia 50mmX1.5mm
Round base plate with
3Nos. holes
For 10mm to 12mm thick
glass & handrail dia 50mm

GRADE
SS 304

Available Finish: SSS

OZRST-44 SERIES



OZRST-44-3R
40X40X1.5mm
Square base plate with
4Nos. holes
For Mid rail Dia 12mm &
Hand rail Dia 50mm

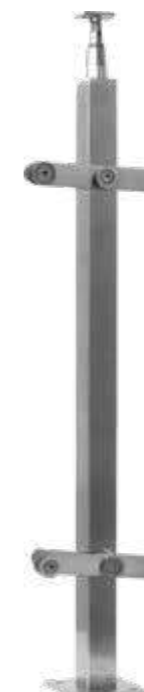

OZRST-44-GH
40X40X1.5mm
Square base plate with
4Nos. holes
For 8 to 12mm thick glass &
handrail dia 50mm

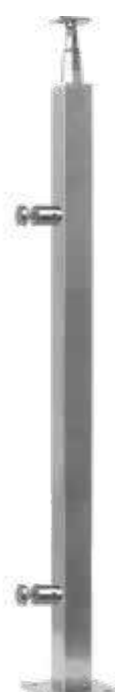

OZRST-44-DGH
40X40X1.5mm
Square base plate with
4Nos. holes
For 8 to 12mm thick glass &
handrail dia 50mm



OZRST-44-GC1
40X40X1.5mm
Square base plate with
4Nos. holes
For 10mm to 12mm thick
glass & handrail dia 50mm



OZRST-44-GC2
40X40X1.5mm
Square base plate with
4Nos. holes
For 10mm to 12mm thick
glass & handrail dia 50mm

GRADE
SS 304

Available Finish: SSS

OZRST-55 SERIES

GRADE
SS 304

Available Finish: SSS



- OZRST-55-3R**
50X10X1.5mm
Rec. base plate with 4 Nos. holes
For mid rail dia 12mm & handrail dia 50mm
- OZRST-55-GH**
50X10X1.5mm
Rec. base plate with 4 Nos. holes
For 8 to 12mm thick glass & dia 50mm handrail dia 50mm
- OZRST-55-DGH**
50X10X1.5mm
Rec. base plate with 4 Nos. holes
For 8 to 12mm thick glass & dia 50mm handrail dia 50mm

OZRST-66 SERIES

GRADE
SS 304

Available Finish: SSS



- OZRST-66-3R**
40X20X1.5mm
Rec. base plate with 4 Nos. holes
For mid rail dia 12mm & handrail dia 50mm
- OZRST-66-GH**
40X20X1.5mm
Rec. base plate with 4 Nos. holes
For 8 to 12mm thick glass & handrail dia 50mm
- OZRST-66-DGH**
40X20X1.5mm
Rec. base plate with 4 Nos. holes
For 8 to 12mm thick glass & handrail dia 50mm

OZREC-11 SERIES

GRADE
SS 304

Available Finish: SSS



- OZREC-11-3R**
40X40X1.5mm
Square base plate with 4Nos. Csk holes
Mid rail dia 12mm & handrail dia 50mm
- OZREC-11-4R**
40X40X1.5mm
Square base plate with 4Nos. Csk holes
Mid rail dia 12mm & handrail dia 50mm
- OZREC-11-GH**
40X40X1.5mm
Square base plate with 4Nos. Csk holes
8 to 12mm thick glass & handrail dia 50mm

OZREC-22 SERIES

GRADE
SS 304

Available Finish: SSS



- OZREC-22-3R**
Dia 38X1.5mm
Round base plate with 3Nos. Csk Holes
Mid rail dia 12mm & Hand rail dia 50mm
- OZREC-22-4R**
Dia 38X1.5mm
Round base plate with 3Nos. Csk Holes
Mid rail dia 12mm & Hand rail dia 50mm
- OZREC-22-GH**
Dia 38X1.5mm
Round base plate with 3Nos. Csk Holes
8mm to 12mm thick Glass & Hand rail dia 50mm

OZRST-77 SERIES

GRADE
SS 304

Available Finish: SSS



- OZRST-77-3R**
50X25X1.5mm
Square base plate with 4 Nos. holes
For mid rail dia 12mm & handrail dia 50mm
- OZRST-77-GH**
50X25X1.5mm
Square base plate with 4 Nos. holes
For 8 to 12mm thick glass & handrail dia 50mm
- OZRST-77-DGH**
50X25X1.5mm
Square base plate with 4 Nos. holes
For 8 to 12mm thick glass & handrail dia 50mm

OZRSU-11 SERIES

GRADE
SS 304

Available Finish: SSS



- OZRSU-11-4R**
40X10mm Solid
Rec. base plate with 4 Nos. holes
For mid rail dia 12mm & handrail dia 50mm
- OZRSU-11-GH**
40X10mm Solid
Rec. base plate with 4 Nos. holes
For 8 to 12mm thick glass & handrail dia 50mm
- OZRSU-11-DGH**
40X10mm Solid
Rec. base plate with 4 Nos. holes
For 8 to 12mm thick glass & handrail dia 50mm

OZREC-33 SERIES

GRADE
SS 304

Available Finish: SSS

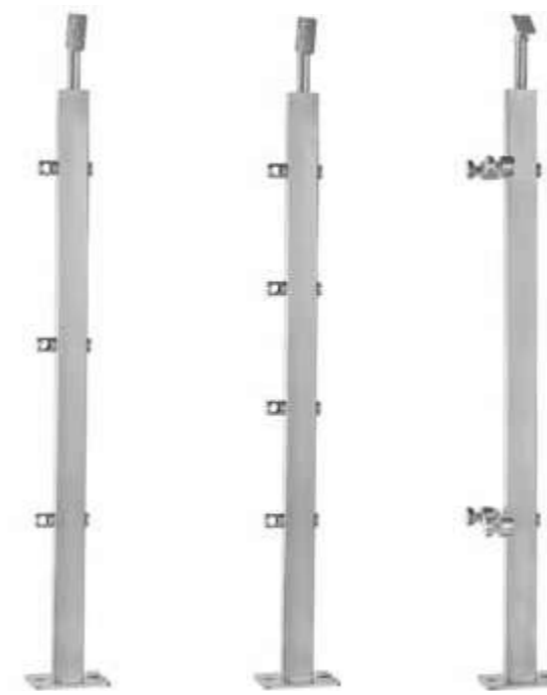

- OZREC-33-3R**
40 X 20X 1.5mm
Rectangular base plate with 2Nos. Csk holes
Mid rail dia 12mm & handrail dia 50mm
- OZREC-33-4R**
40 X 20X 1.5mm
Rectangular base plate with 2Nos. Csk holes
Mid rail dia 12mm & handrail dia 50mm
- OZREC-33-GH**
40 X 20X 1.5mm
Rectangular base plate with 2Nos. Csk holes
8 to 12mm thick glass & handrail dia 50mm

EASY PLUS AUTO SLIDING DOOR SYSTEM (AUTOMATIC SENSOR DOOR FOR LOW TRAFFIC AREA)

OZOM-111E-PLUS-N 4.2MTR SILVER-AN

OZOM-111E-PLUS-N Single 2.4 mtr. STD (For Single Door)

Compact & Slim body | Intelligent Controller | Modular Design | Noiseless Functionality



Features:

- Engine case, height: 128mm
- Engine case cover height: 150mm
- Self learning micro computer processing controller
- Adjustable tensioner wheel
- 24V DC 65W brushless motor
- Digital adjustable parameters
- Controller with built-in remote control receiver
- In-built electromagnetic locking

Specifications:

- Single / Bi-parting sliding door system
- Suitable door weight : 100 Kg x 2 Per Panel
- Maximum door opening : 2mtr
- Adjustable parameters for opening speed, closing speed, opening buffer speed, closing buffer speed, opening buffer distance, closing buffer distance, opening time & opening force
- Integration possible with Microwave Sensor, Handwave Sensor, PIR Sensor, Digital Door Key, Finger Print Controller Wireless Push Button, Safety Beam, Remote Control, Push Buttons etc
- Warranty will be lapsed in absence of CVT.

Track length option:

- 4.2mtr/2.4mtr

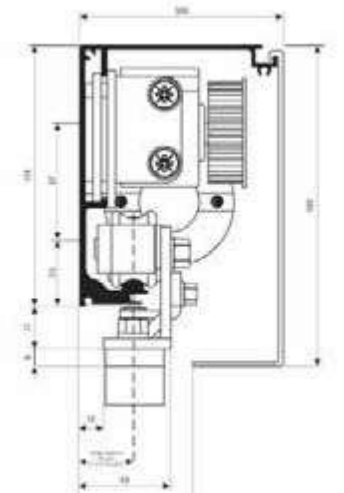

AUTOMATIC DOOR SYSTEMS HOTEL RFID LOCKS & DIGITAL LOCKS

Ozone Automatic Door systems are designed to meet the ease of entry, safety, & security requirements. The exibility in design & installation allows Ozone Automatic Door systems to get integrated in any type of architecture.

**PREMIUM PLUS AUTO SLIDING DOOR SYSTEM
(HIGH TRAFFIC AREA, HEAVY DUTY DOOR)**

OZOM-111P-PLUS 4.2MTR SILVER-AN
OZOM-111P-PLUS 5.2MTR SILVER-AN
OZOM-111P-PLUS 6MTR SILVER-AN

Compact & Slim body | Noiseless Functionality | Intelligent Controller | Modular Design



SS-316

Also available in: **BM**



Track length option:

- 4.2mtr/5.2mtr/6mtr

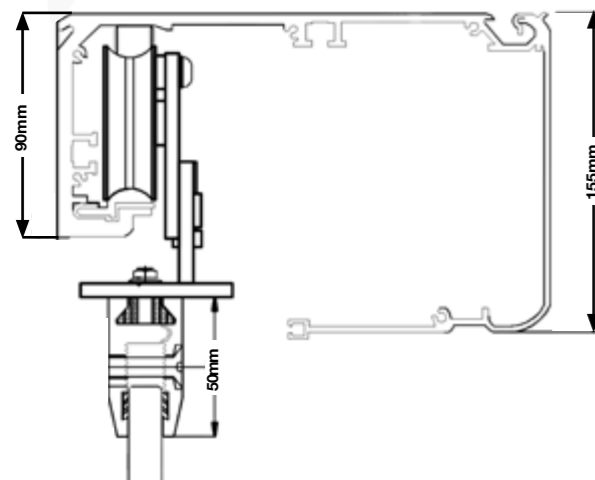

Features:

- Engine case, height: 90mm
- Self-learning micro-computer processing controller
- Slim type track
- 24V DC 65W brushless motor with built-in rectifier
- Adjustable parameters
- Engine case cover height: 155mm
- Controller with built-in remote control receiver
- Adjustable tensioner wheel
- Operating standard cycle for 5,00,000 cycles in-house tested

Specifications:

- Single/Bi-parting sliding door system
- Suitable door weight : 120Kg x 2
- Maximum door width : 2/2.5/3mtr
- Adjustable parameters for opening speed, door buffer distance, door buffer intensity, closing speed, closed buffer distance, closed buffer force, opening hours, & starting force
- Integration possible with Microwave Sensor, Handwave Sensor, PIR Sensor, Digital Door Key, Wireless Push Button, Safety Beam, Remote Control, Push Buttons, etc.
- Warranty will be lapsed in absence of CVT.

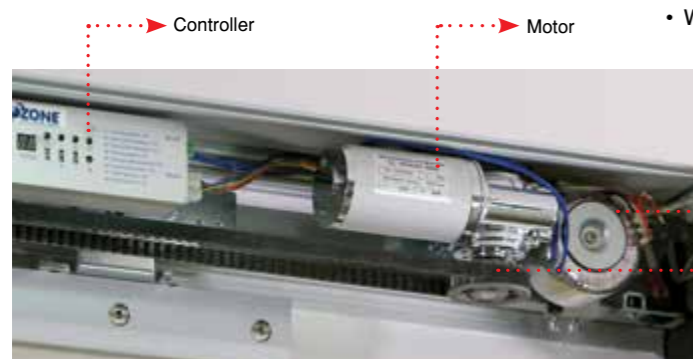

Scan QR for
Installation Video



SS-316

**AIRDRIVE - THE WORLD'S SLIMMEST
AUTOMATIC SLIDING DOOR SYSTEM**

OZOM-AD68N 4.5mtr.
OZOM-AD68N 5.9mtr.



Features:

- Manufactured as per ISO 9001 : 2000 standards
- CE conformity & compliant with EU Standards EN 16005, EN 60335, EN ISO 13849 1:2008 & German standard DIN 18650
- Exquisiteness combined with strength & soft performance
- Ability to work with 20% higher or lower than nominal input voltage
- Completely protected system input ports which reduces the damage risk due to human error during installation
- Self-diagnose and error detection
- Ability to automatically adjust speed and slopes according to input voltage change
- Best choice for professionals who wish to create pure beauty & graceful architecture

Specifications:

- Track/engine case: 68 x 135 mm (ht x depth)
- Track length: 4.5 & 5.9 mtr
- Door type: automatic
- Single leaf door weight: 1 x 150kg
- Double leaf door weight: 2 x 120kg
- Maximum door opening width: 2000 mm for single panel & 3000 mm for double panel
- Motor: compliant with EU low voltage directives with Maximum power consumption of 250W
- Opening speed: adjustable 100-550mm/sec
- Closing speed: adjustable 100-500mm/sec
- Warranty will be lapsed in absence of CVT.

Slimmest Track of 68mm height

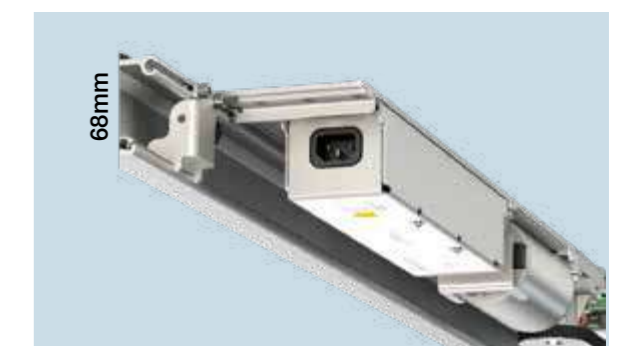

MAGNETIC PLUS GLIDE SLIDING DOOR SYSTEM

S Series
Premium Collection of
Architectural Hardware

SS-316

Also available in: **BM**

Ozone Plus Glide is an automatic sliding door system that runs on a magnetic linear motor technology which is safe, noiseless, and a reliable technology. It reduces operating cost, hence, is a cost effective solution for commercial spaces like offices, hotels, & hospitals. Ozone Plus Glide System can be applied in any of the entrances and can be integrated with door control devices.



OZONE+Glide

- Works on magnetic linear motor technology
- Reduces operating cost
- Can be integrated with door control devices such as push button, microwave sensor, etc.
- Slim size
- Suitable for Wood, Glass & Framed Doors

MAGNETIC PLUS GLIDE SLIDING DOOR SYSTEM

S Series
Premium Collection of
Architectural Hardware

SS-316

Ozone Plus Glide OZOMSG-150



Ozone Plus Glide OZOM-SG-150

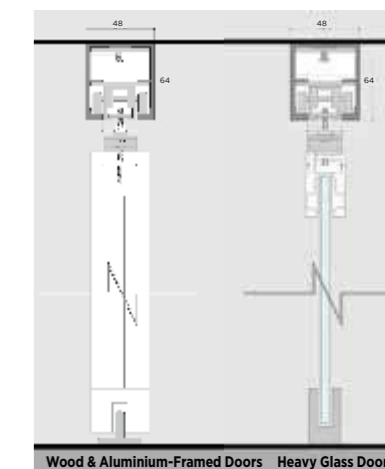

Technical specifications:

- Movement range: 750–1000mm
- Door weight: 50–150kg
- Opening/closing speed: 200–500mm/s
- Hold open time: 0–30sec
- Magnetic holding power: Suction 10N
- Manual opening: 10N
- Anti-pinch force: 10N
- Average power: 30W
- Track length: 2100mm

Functions:

- Standard con guration: automatic mode, manual opening
- Adjustment of opening/closing speed and hold open time
- Automatic memory
- Smooth sliding operation
- Anti-pinch and overload protection
- Can be used with external control switch

Optional Accessories:



v-02
Wireless Push Button



OZOM-SG-ACC-01
Remote Control

OZOM-SG-080 2.1mtr.
OZOM-SG-080 4.2mtr.



Ozone Plus Glide OZOM-SG-080

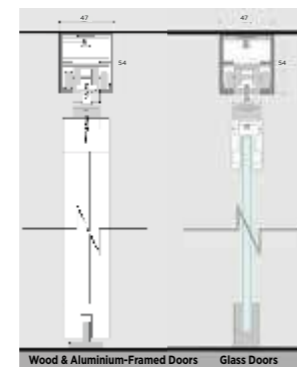

Technical specifications:

- Movement range: 750–1000mm
- Door weight: 30–80kg
- Opening/closing speed: 200–500mm/s
- Hold open time: 0–30sec
- Magnetic holding power: Suction 10N
- Manual opening: 10N
- Anti-pinch force: 10N
- Average power: 30W
- Track length: 2100mm

Functions:

- Standard con guration: automatic mode, manual opening
- Adjustment of opening/closing speed and hold open time
- Automatic memory
- Smooth sliding operation
- Anti-pinch and overload protection
- Can be used with external control switch

PANIC BREAKOUT - AUTOMATIC SLIDING DOOR SYSTEM

OZOM-PB-G STD



Best for larger door passage requirement



Get wider door opening with panic breakout feature



Panic breakout feature facilitates quick evacuation

Specifications:

Single leaf Door Weight	100 Kg
Double leaf Door Weight	100x2 Kg
Power consumption	200W
Ambient temperature	-30~+50° C
Motor	Dunkermotoren from Germany
PSA control Panel	37 parameters could be set
Track and Cover	High strength, 5mm thickness

Features:

- Includes overlapping frames and sealing to ensure air tightness
- Intelligent design, easy to install, and adjust
- UPS backup battery ensures the door operating 30 minutes normally if power fails (Optional)
- Automatic stop function
- Push open at any position
- Warranty will be lapsed in absence of CVT

Applications:

- Airports, Shopping Malls, Car Showrooms, and Warehouses

TELESCOPIC AUTOMATIC SLIDING DOOR SYSTEM

Ozone Telescopic Automatic Door System is designed to work on double pulley mechanism that enables wider door opening with less parking space. With our Telescopic Automatic Door System, you can achieve upto 3mtr wide door opening making it best suitable for automobile showrooms and areas of high traffic movement.



OZOM-11-T 4.2mtr.
OZOM-11-T 5.0mtr.

Telescopic Automatic Sliding Door System with one on one panel

TECHNICAL PARAMETER	OZOM – 11T
Power	AC 220V (50-60 Hz), AC 110v (option)
Controller	Micro-Processing
Motor	DC 24V 60W/90W
Door weight maximum	90kg x 2/125kg x 2
Door width	Minimum 550mm
Opening time	0-10 sec.(Adjustable)
Power Transfer	UPS, Program switch

Features:

- For a wider door opening space, install 02 panels door in a space of one
- 02 door panels move at 2:1 speed ratio at the same time
- Warranty will be lapsed in absence of CVT

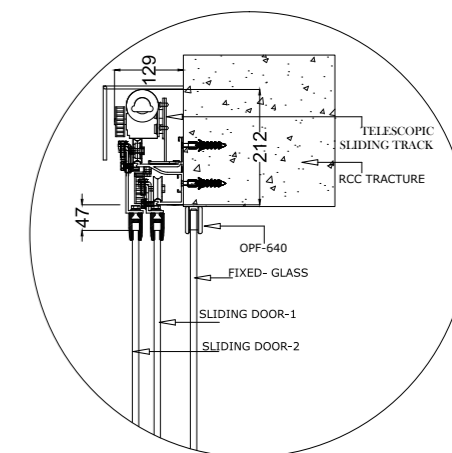
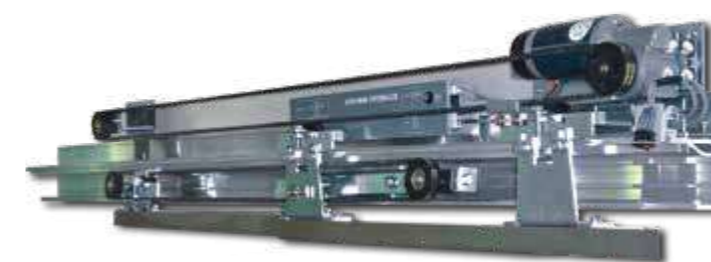

REVOLVING DOOR SYSTEMS



A building entrance should ensure smooth & secure traffic passage and at the same time add aesthetic value. Hence, a door system should be chosen which meets functional as well as aesthetic requirement of the space. Ozone Revolving Doors are just the right fit for such building entrances. They offer varied security & functionality benefits along with outstanding user experience and impart a spectacular look to the entrance.

*OZONE Revolving Door Systems:

- Available with 3 or 4 leaf configuration
- Automatic and manual options
- Certified for EN 16005: 2012 & EN 60204-1: 2006+A1: 2009 to meet safety & functional standards
- Suitable for main entrances of commercial establishments
- Ensure safe & smooth Traffic flow
- Anti-collision & Anti-squeeze Function
- Custom solutions available
- Technical support provided



Emergency Stop Button

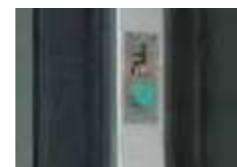

Slow Turning Feature for Specially Abled People

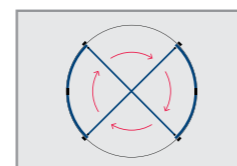

4 Leaf Revolving Door



3 Mode Selection Lock Key



Side & Bottom Brushes to Prevent AC Loss

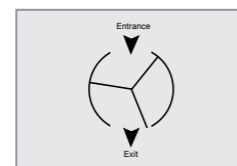

3 Leaf Revolving Door.



Radar Detectors

REVOLVING DOOR SYSTEMS

*Manual Revolving Door Technical Parameters

DOOR PARAMETERS	MANUAL REVOLVING DOOR
Type of drive unit	Manual
Roof outside color	Anodized
Roof outside	Water proof with 2 side drainages
Diameter	1800-3600mm
Total height	2500mm
No. of door leaves	3/4 leaf
Optional accessories (Additionally Charged)	Speed control system & panic breakout available

*Automatic Revolving Door Technical Parameters

DOOR PARAMETERS	AUTOMATIC REVOLVING DOOR
Type of drive unit	Automatic
Roof outside color	Anodized
Roof outside	Water proof with 2 side drainages
Diameter	1800-3600mm
Total height	2500mm
No. of door leaves	3/4 leaf
Door locking	Key locking with drop bolt
Lighting	3x12V decoration light
Accessories	Emergency stop button, drive unit, button programme switch & handicap switch (2 sets)
Sensor	Radar sensor
Safety Sensor	Leading mullion sensor (safety sensor for inside and outside entrance)
Power supply	220V/AC 10% 50 Hz
High speed adjustment range	1-4 RPM
Low speed adjustment range	0.5 - 1.5 RPM
Motor Power	250W
Lighting power	300W
Control system power	50W

*Technical specification will vary as per project requirement.

*Available on Specific Demand

PUSH AND GO AUTOMATIC SLIDING DOOR SYSTEM

OZOM-11F-S-SYS STD SSS
OZOM-11F-S-TRACK 2 MTR SSS

S Series
Premium Collection of
Architectural Hardware

SS-316



Features:

- Designed in compliance with EN 16005 Low Energy Operating Standard for 5,00,000 cycles
- Slim Size Track (mm): (H)75 x (W)77 x (L)2000mm
- Can be converted to semi-automatic door
- For Internal applications

Specifications:

- Suitable for door weight: 20-80Kg
- Power supply 100~240V AC ; 50/60 Hz
- Power consumption 5W in stand-by mode & 40W (Maximum) in automatic mode
- 2mtr. aluminium track with SS finish
- For single panel sliding door, frameless glass, or framed door
- Same product & installation of right-to-left or left-to-right door opening
- Integration possible with microwave sensor, wireless push button, digital door key (RFID Card access control), hand wave sensor, etc.
- Can be operated by gentle manual push to the door
- High degree temperature resistance belt (20 -130)
- Safety beam barrier not required
- Warranty will be lapsed in absence of CVT.

Certified : CE, EN 16005
Low Voltage European Directive
2014/35/EU



Hanger Roller



Controller

RETROFIT AUTOGLIDE DOOR SYSTEM

OZOM-AG-01 STD BLACK



Features:

- Converts existing manual sliding door or window into automatic sliding
- Suitable for residential applications

Specifications:

- Single leaf door weight: 80Kg
- DC 24V 45W brushless motor
- Can be installed on doors of kitchen, balcony, office, shop front, aisle, french window, or other sliding windows
- Suitable door width: 500-1000 mm
- Voltage: AC 100-240V
- Opening speed: 10-45 cm/s (Adjustable)
- Closing speed: 10-25 cm/s (Adjustable)
- Compatible with sensor, remote control, push button, RFID card reader, etc.

Accessories:

- With 2 Nos. wireless push buttons/remote control



Wireless Push Button



Inside View of the Controller

White Colour Option
(Available against confirmed orders)



Watch Video

SEMI AUTOMATIC SLIDING DOOR SYSTEM

OZOM-SA-111-N

The Semi Automatic Doors System is a sliding door which is opened manually but closes automatically on its own with the help of an air cylinder mechanism. It does not require any electrical connection. Another important feature of this door is that it closes softly on the last end making the process smooth and silent. The closing speed can be adjusted as per the traffic movement and opening size. The Maximum door width possible for this system is 1000mm (track length 2100mm) and the Maximum door weight is 80kg. The door can be integrated with standard locks. An ideal application for these doors is rest room entrances, conference rooms, etc. The system can be used for frameless glass doors as well as framed/wooden doors.



Semi-Automatic Door Technical Parameters

TECHNICAL PARAMETERS	OZ-OM-SA-111
Single leaf Maximum opening width	1000mm
Maximum door weight	80Kg
Maximum door height	2100mm
Door Type	Framed & Frameless doors
Door parking when open	Possible
Glass cut-out	Not required

Features:

- Suitable for Frameless glass doors, wooden doors, & framed doors
- Door open manually and closes automatically
- Come with in-built air cylinder mechanism
- No electrical connection required
- Soft & Silent door closing
- Closing Speed can be adjusted
- Standard locks available in market can be integrated

Ideal Application: Rest room entrances, office cabins, conference rooms, and meeting rooms.

OZOM-AC-99 STD SILVER

Microwave Sensor

High sensitivity, wide range eagle type sensors with least interface with industrial noise.



OZOM-AC-99 STD BLACK



Avoid extreme vibration

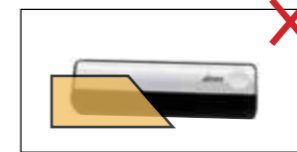

Do not cover the sensor



Avoid moving objects & light sources in the detection field

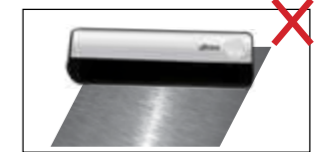

Avoid highly reflective objects in the infrared field

Technical Specification

Technology	Microwave and Microprocessor
Transmitter frequency	24.125 Ghz
Transmitter radiated power	<20dBm EIRP
Transmitter power density	<5mW/cm ²
Detection mode	Motion
Minimum detection speed	5 cm/s (measure in the sensor axis)
Supply voltage	12V-24V AC+/-10%, 12V-30V DC
Mains frequency	50 to 60 Hz
Maximum power consumption	<2W (VA)
Output	relay (free of potential change-over contact)
• Maximum contact voltage	42V AC-60V DC
• Maximum contact current	1A (resistive)
• Maximum switching power	30W (DC)/60VA (AC)
Maximum mounting height	3m
Protection degree	IP54
Temperature range	from- 20 C to +55 C

Specification are subject to change without prior notice

OZOM-AC-99N STD BLACK

Microwave Sensor

High sensitivity, wide range eagle type sensors with least interface with industrial noise.



Technical Specification

Technology	Radar 24.125 GHz
Mounting Height	1.8 - 4m
Operating Voltage	12-36 VDC / 12-28 VAC
Operating Current	max 32 mA at 24 VDC
Power Consumption	max. 1.3 W
Output Radar	max. switching voltage: 48 VAC/VDC max. switching current: 120 mA max. switching current: 550 mV
Protection Type	Suitable for use acc. to IP54
Operating Temperature	-20 to 60 C
Dimensions	172x60x48mm(LXWXD)
Output	relay (free of potential change-over contact)
• Maximum contact voltage	42V AC-60V DC
• Maximum contact current	1A (resistive)
• Maximum switching power	30W (DC)/60VA (AC)
Weight	120g
Cable Length	3m

OZOM-AC-11-ZS

Combo Microwave Sensor: High sensitivity, wide range eagle type sensors with least interface with industrial noise. Infrared Sensor for Active and presence detector.

Opening & safety sensor for automatic sliding doors

Other use of the device is outside the permitted purpose and can not be guaranteed by the manufacturer. The manufacturer cannot be held responsible for incorrect installations or inappropriate adjustments of the sensor.

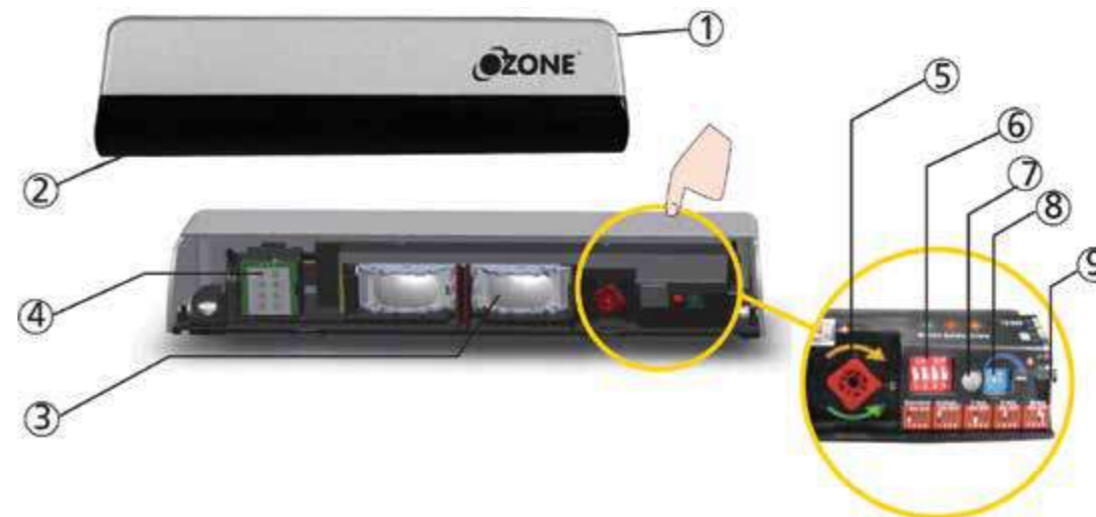

- 1. Cover
- 2. Front cover
- 3. Infrared lens
- 4. Microwave antenna
- 5. IR-curtain adjustment screw
- 6. Dip switch
- 7. LED
- 8. Microwave sensitive potentiometer
- 9. Cable plug

Technical Specification

Supply voltage:	12 V-24 V AC +/-10% ; 12 V-30 V DC 0%/+10%	
Power consumption:	< 3W	
Mounting height:	1.8m to 3m	
Temperature range:	-25 C to +55 C	
Degree of protection:	IP54	
Detection mode:	Motion Minimum detection speed: 5cm/s	Presence Typical response time: <128ms (Maximum 500ms)
Technology:	Microwave doppler radar Transmitter frequency: 24.150 GHz Transmitter radiated power: < 20 dBm EIRP Transmitter power density: < 5 mW/cm2	Active infrared with background analysis Spot diameter: 6cm Number of spots: 24 by curtain Number of curtains: 1
Angle:	From 15 to 45 vertical (adjustable)	From -5 to +8 (adjustable)
Output:	Relay (free of potential) Maximum contact voltage: 42 V AC/DC Maximum contact current: 1A (resistive) Maximum switching power: 30W (DC)/60 VA (AC)	Relay (free of potential) Maximum contact voltage: 42V AC/DC Maximum contact current: 1A (resistive) Maximum switching power: 30W (DC)/60 VA (AC)
Hold time output signal:	0.5s	0.5s

Specification are subject to change without prior notice

AUTO DOOR ACCESSORIES



OZOM-PR-11
Aluminium clamp
Available in 1mtr. &
1.5mtr (pcs)



OZOM-FG-22
Floor guides for framed doors
with adjustable width (pcs)



OZOM-SB-11N STD SS
OZOM-SB-12 (Double Barrier)



OZOM-SW-11 Std Std
Large area push button
for automatic doors



OZOM-SW-11M Std Std
Metallic wall mounting
push button switch



OZOM AC-66 PIR
Ceiling mounting PIR
sensor



OZOM-SB-11N
(Single Barrier)
Use with OZOM-111E



OZOM-FG-11
Floor guides for frameless
glass doors (pcs)



OZOM-111P-Plus Remote
Remote Control



OZOM-HWS-11
Hand Wave Sensor



OZOM-FPC-11M
Finger Print Access Control



OZOM-WPB-22
Wireless Push Button



OZOM-111E-PLUS-N REMOTE
Remote Control



OZOM-111P-Plus-ACC-MFS
Multi-Function Switch



OZOM-11P-AC-11
Remote Control for
Automatic Sliding Door



OZOM-AC-22-FS
Foot Sensor Switch
Activates the door to open
when the switch senses the foot.



OZOM-111E-PlusN-ACC-EML- Std Std
Electro Magnetic Lock



OZOM-111P-Plus-ACC-EML- Std Std
Electro Magnetic Lock

AUTOMATIC SWING DOOR OPERATORS FOR GLASS AND WOODEN DOORS

SINGLE ACTION OVERHEAD DOOR OPERATOR For Wooden and Framed door



OZOM-SD-200 STD AN
Automatic overhead door operator
Warranty will be lapsed in absence of CVT.



Watch Video

DOUBLE ACTION CONCEALED DOOR OPERATORS



OZOM-CSD-T STD SS
Top mounted concealed door operator

- Maximum Door Width (Wooden and Framed Door): 1500mm.
- Maximum Door Width (Frameless Glass Door): 1200mm.
- Suitable for Wooden, Framed and Frameless Glass Door.
- Warranty will be lapsed in absence of CVT
- Extra hardware for Glass door: E-Series Patch Fittings



OZOM-CSD-B STD SS
Bottom mounted concealed door operator

- Maximum Door Width (Wooden and Framed Door): 1500mm.
- Maximum Door Width (Frameless Glass Door): 1200mm.
- Suitable for Wooden, Framed and Frameless Glass Door.
- Warranty will be lapsed in absence of CVT
- Extra hardware for Glass door: E-Series Patch Fittings

Note: Extra hardware for Glass door: E-Series Patch Fittings.

Applications:

- Hospitals
- Hotels
- Passage/Lobby
- Specially-abled Toilets
- Retail Outlets
- Offices/Residential apartments/ Public Buildings
- Airports

Operator can be integrated with:

- Microwave sensor
- Foot switch sensor
- Handwave sensor
- Electromagnetic locking machine
- RFID/Numeric/Fingerprint access control system
- Push Button

AUTOMATIC SWING DOOR OPERATORS TECHNICAL DATA TABLE

TECHNICAL PARAMETERS	OZOM-SD-200 STD AN	OZOM-CSD-T STD SS	OZOM-CSD-B STD SS
Maximum Door Width	1500mm	1500mm	1500mm
Maximum Door Weight	200kg	150KG	150KG
Opening Direction	Single action	Double Action	Double Action
Accessories Included	Controller, machine and remote	Controller, machine and remote	Controller, machine and remote
Installation Type	Top Installation	Top Installation	Floor Installation
Maximum Motor Power	65W/100W	65W/100W	65W/100W
Motor	DC 24V 55W/100W Brushless Motor	DC 24V 55W/100W Brushless Motor	DC 24V 55W/100W Brushless Motor
Closing Speed	10~43cm/s	3~14cm/s	3~14cm/s
Open Door Hold Time	0.5~10 s	0.5~10 s (adjustable)	0.5~10 s (adjustable)
Open Range	70° ~ 115°	±90°	±90°
Supply Voltage	AC110V/AC220V 50Hz~ 60Hz	AC110V/AC220V 50Hz~ 60Hz	AC110V/AC220V 50Hz~ 60Hz
Use Temperature	-30° C ~ +50° C	-30° C ~ +50° C	-30° C ~ +50° C
Use Humidity	Less than 85%	35 ~ 85%RH (non-condensing)	35 ~ 85%RH (non-condensing)
Protection Level	IP64	IP64	IP44
Extended Function	Safety light eyes, such as remote control of various types of access control	Safety light eyes, such as remote control of various types of access control	Safety light eyes, such as remote control of various types of access control
Watt Power	14W	14W	14W
Fuse	Minimum 3.5A Slow	Minimum 2.5A	Minimum 2.5A
Maximum Current	1A	1A	1A
Dimensions	544x72x106 mm	288x86x72 mm	340x82x166 mm
Single/Double Door use	One set for single door, 2 set for double with common accessories	One set for single door, 2 set for double with common accessories	One set for single door, 2 set for double with common accessories
Product Image			

HOTEL RFID CARD LOCKS



OZEL-RF-V9-666L STD SILVER
OZEL-RF-V9-666R STD SILVER
Software Based Hotel Door Lock



OZEL-RF-V9-777L STD SILVER
OZEL-RF-V9-777R STD SILVER
Software Based Hotel Door Lock

HOTEL RFID CARD LOCKS



OZEL-RF-V11-444 R/L SSS
OZEL-RF-V11-444 R/L PSS
Software Based Hotel Door Lock



OZEL-RF-V11-555 R/L SSS
OZEL-RF-V11-555 R/L PSS
Software Based Hotel Door Lock

ACCESSORIES FOR V-11 LOCKS



OZEL-RF-V11-ACC-CARD
Std Std
RFID Card



OZEL-RF-V11-ACC-QC
Std Std
Query Card



OZEL-RF-V11-ACC-PS
White Std
Power Saver (30 AMP)



OZOM-RF-HLMS
Hotel Lock
Management S/W



OZEL-RF-V11-ACC-CR
Black Std
Card Reader

*Available on request

SOFTWARE BASED HOTEL DOOR LOCK



***OZEL-RF-111L-O**
***OZEL-RF-111R-O**
Opera Software Based Hotel Door Lock
(Available in satin finish)

*Available on request

ACCESSORIES FOR V9-666 & V9-777 L/R STD LOCKS



OZEL-RF-V9-ACC-PS WHITE STD
Power Saver



OZEL-RF-V9-ACC-DC STD WHITE
Data Collector



OZOM-RF-HLMS
Hotel Lock Management S/W



OZEL-RF-V9-ACC-CR STD BLACK
Card Reader



OZEL-RF-V9-ACC-CARD STD WHITE
RFID Card

ACCESSORIES FOR OZEL-RF-111-O L/R STD



***OZEL-RF222/333-PS**
V10 White
Power Saver (30 AMP)



***OZEL-RF-111-Card-**
V10-O-White
RFID Card



***OZEL-RF-111-CR**
-V10-O-STD
Card Reader



OZOM-RF-HLMS
Software



OZEL-RF-DC-V10-O-STD-White
Data card

HOTEL RFID CARD LOCKS



HOTEL RFID CARD LOCKS



Automatic Doors



***OZEL-RF-222L/R**
Software Based Hotel Door Lock
(Available in chrome & satin finish)



***OZEL-RF-333L/R**
Software Based Hotel Door Lock
(Available in gold & satin finish)

ACCESSORIES FOR OZEL-RF-222 L/R & 333 L/R



OZEL-RF-DC V10 Std
Hand Sim



***OZEL-RF-222/333-CR**
V10 Std
Card Reader



***OZEL-RF-222/333 Card**
V10 White
RFID Card



***OZEL-RF-222/333-PS**
V10 White
Power Saver (30 AMP)

Automatic Doors

HOTEL RFID LOCKS WITH IDS AND OPERA INTEGRATION



OZEL-RF-V5-888R STD SS
OZEL-RF-V5-888L STD SS
IDS & Opera Software Based Hotel Lock

*Available on request against Project Order



OZEL-RF-V5-999R STD BM
OZEL-RF-V5-999L STD BM
IDS & Opera Software Based Hotel Lock

ACCESSORIES FOR OZEL-RF-V5-888 L/R & 999 L/R



OZEL-RF-V5-ACC-CR Std Black
Card Reader



OZEL-RF-V5-ACC-Card Std White
RFID Card



OZEL-RF-V5-ACC-PS
Std White
Power Saver



OZEL-RF-V5-ACC-DC
Std White
Data Card

DIGITAL GLASS DOOR LOCKS



OZ-FGL-LIFE-G2G
Glass-to-Glass Doors

New

Specifications:

- Suitable for Glass door thickness of **10mm~12mm**
- Material- Zinc Alloy & ABS

Features:

- 5 ways access: Mobile App, Fingerprint, RFID Card, User Pin Code, Unlock Through Remote
- Automatic Locking System
- Passage (open) Mode

Applications:

- Residential Apartments, Libraries, Offices, Hospitals



OZ-FGL-LIFE-G2W
Glass-to-Wall Doors



Access Options:



Fingerprint



RFID Card



User Pin Code



Mobile Access



Remote Unlock
(Optional)

**APP CONNECTED DIGITAL LOCK
FOR SLIDING AND SWING GLASS DOORS**

NO
Glass Cut-out
Required



OZ-FGL-BL-G2G Black
Glass-to-Glass application

360° Fingerprint Recognition

Specifications:

- Suitable for Glass door thickness of **10mm~15mm**
- Material- Zinc Alloy

Features:

- 4 ways access: Mobile App, Fingerprint, RFID Card, User Pin Code
- Automatic Locking System
- Passage (open) Mode

Applications:

- Residential Apartments, Libraries, Offices, Hospitals



OZ-FGL-BL-G2W Black
Glass-to-Wall application



Access Options:



Fingerprint



RFID Card



User Pin Code



Mobile Access

SMART PULL HANDLE LOCK FOR SAFE & SECURE ENTRANCES



Suitable for Glass, Wooden and Framed Doors

Specifications:

1. Lock can register upto 100 fingerprints
2. Packaging includes 5 RFID cards
3. Can register upto 1,000 cards
4. Works on 4 nos. 1.5 volt AA battery
5. Available in two sizes with 12mm hole dia



Watch Video

Features:

1. Access options:
 - Outside: 4 ways- Fingerprint, User pin code, RFID & Remote control (optional)
 - Inside: Touch exit button
2. Low battery alarm
3. Doorbell function

Applications: •Hotels •Offices •Residences •Hospitals

Access Options:



Finger Print



User Pin Code



RFID Card



Remote Control

How to Order				
Image	Application	Panel Thickness	Item Code	Description
	For Glass Doors	Without Overpanel	OGHL-S-11A 500mm Black	Single lock
			OGHL-D-11A 500mm Black	Double lock
			OGHL-S-11A 800mm Black	Single lock
			OGHL-D-11A 800mm Black	Double lock
	For Glass Doors	With Overpanel	OGHL-S-11B 500mm Black	Single lock
			OGHL-D-11B 500mm Black	Double lock
			OGHL-S-11B 800mm Black	Single lock
			OGHL-D-11B 800mm Black	Double lock
	For Wooden Doors	Without Overpanel	OWHL-S-11 500mm Black	Single lock
			OWHL-D-11 500mm Black	Double lock
			OWHL-S-11 800mm Black	Single lock
			OWHL-D-11 800mm Black	Double lock

Length	CTC
500mm	300mm
800mm	600mm



OGHL-ACC-RC
Remote Control Device
(*optional)

OZOM-AS-45DB 85MM STD
OZOM-AS-52DB 100MM STD

Available against orders only

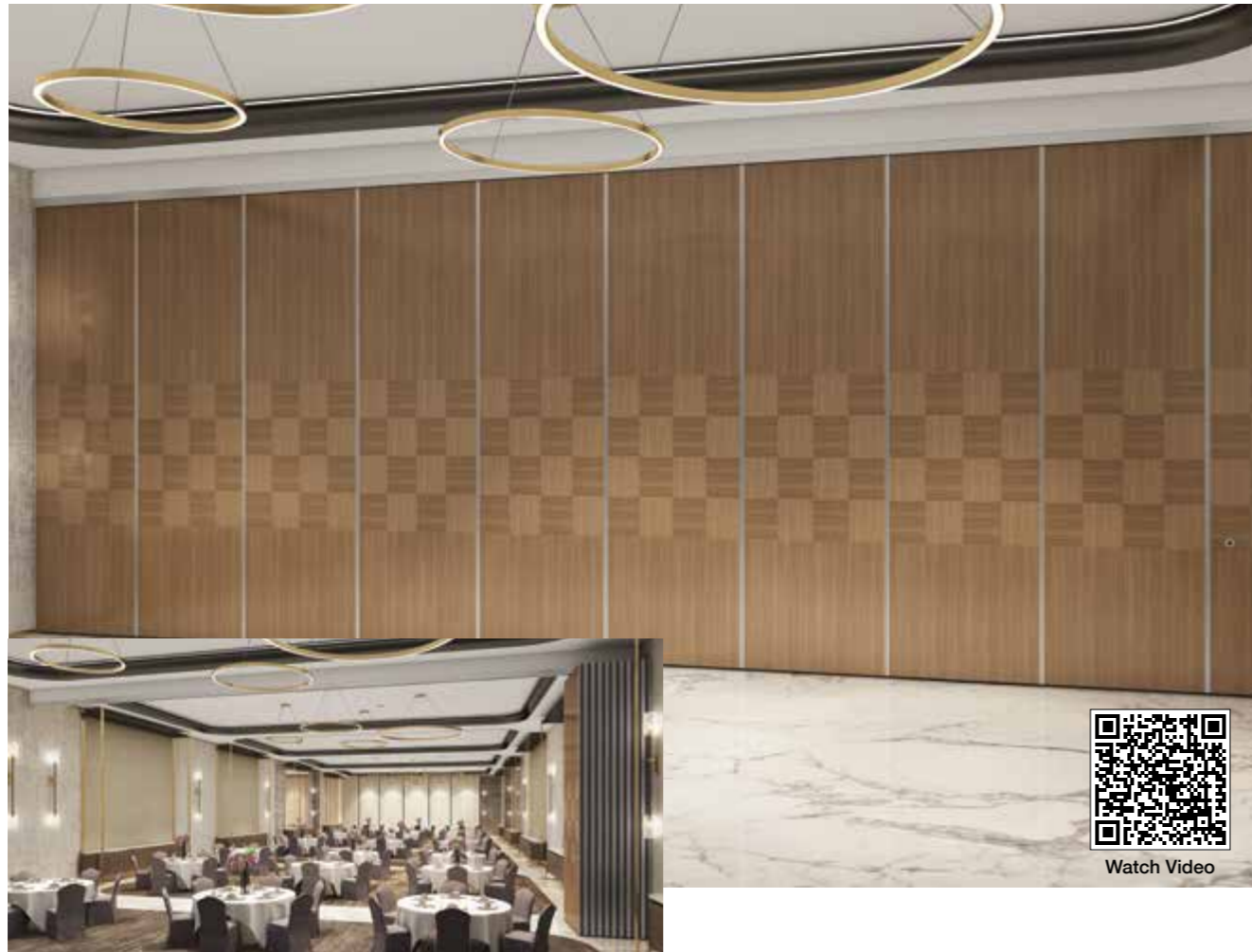

STANDARD SPECIFICATIONS:

Movable Acoustic Wall Partition System shall consist of top hung manually operated acoustic panels which can be linked together to form an acoustic wall.

PANELS: Based on the requirement the panels shall be constructed of board separated by acoustic insulation to achieve the specified sound rating. Panel Faces are replaceable at the site.

ACOUSTICS: Acoustic walls are classified by a STC (Sound Transmission Class) rating for their effectiveness in reducing transmitted sound. Based on Acoustic Requirements the panels shall be of STC 45 or STC 52. STC 45 shall make the wall with loud speech barely audible on other side & STC 52 shall make the wall with shouting barely audible on other side.

CLOSURE: The movable acoustic wall shall be acoustically opened & closed with the help of an expanding panel located at the stacking end of the system. There is an over-sleeve on the expanding panel which can be expanded side ways to lock the acoustic wall in place. The oversleeve is expanded and retracted by a removable handle in the face of pane.

STACKING: While opening of movable acoustic wall, panels shall be parked in a side stack configuration which means that single panels are hung at two points at the top corners of each panel. Panels will stack with one point remaining on the main track and other on the side track.

SEALS: There shall be sweep seals at the top of the panels to seal them acoustically to the track. There shall be retractable seals at the bottom of the panels to seal them acoustically to the floor.

For wooden partitions:

Panel Thickness	DB Value	Maximum Panel Height	Maximum Panel Width
85 mm	45 DB	12000	1250
100 mm	52 DB	12000	1250

For glass (see through) partitions:

Panel Thickness	DB Value	Maximum Panel Height	Maximum Panel Width
85 mm	43 DB	6000	1200

OMAW - MOVABLE ACOUSTIC WALL PARTITION SYSTEM

Stacking Options

One Point Suspension & perpendicular to track

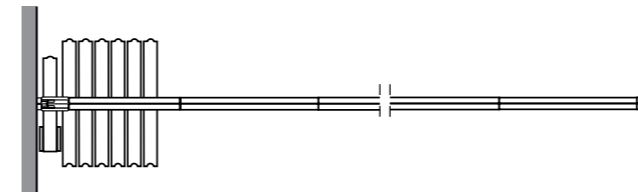

Two Point Suspension & perpendicular to track

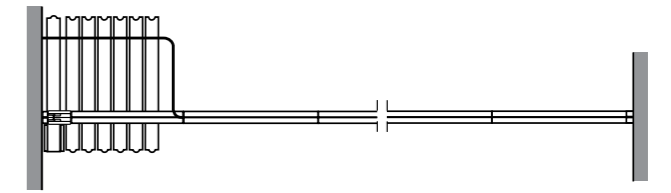

Two Point Suspension & parallel to track

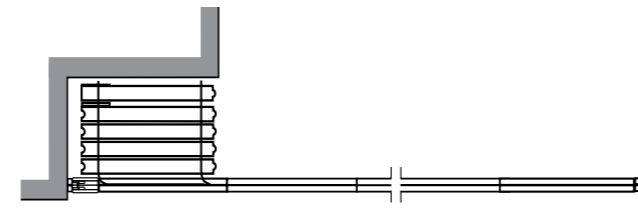

Two Point Suspension, perpendicular to track & multiple stacks

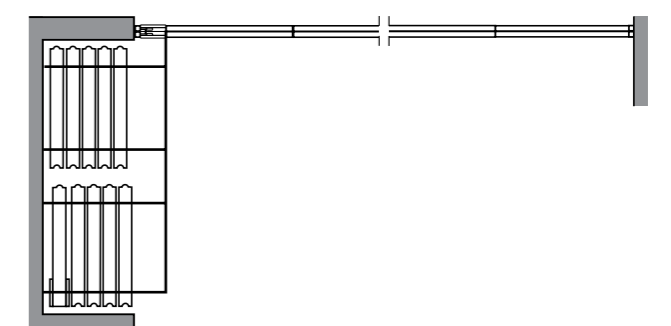

Two Point Suspension, perpendicular to track in closed compartment

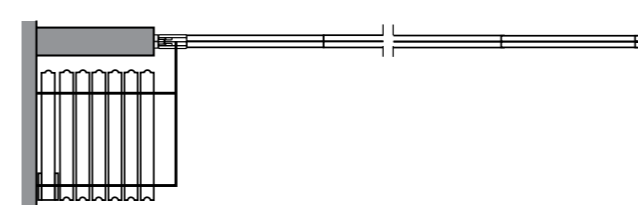

HERMETICALLY SEALED FRAMED DOORS*

Ozone offers a new range of specialized doors for application in hospitals, X-ray rooms, research labs, clean rooms, environment controlled R&D centers, etc. The range includes Hermetically Sealed Framed Doors & X-Ray Shielding Doors.
For more details mail to support@ozone-india.com.

- Adopting original air-tight technology rubber pad and a rail-way arranged at the bottom of the door leaf ensures weather proof solution.
- Door with sealing strips on all four sides. Aluminum alloy section, dynamic beam with life span of more than 1 million operations.
- Controllers like foot sensing switch, microwave sensors, remote controller, electronic lock switches, infra red sensors, ATM card reader, password and card reader, and proximity sensors ensure that operation of the door has various options to suit every one.
- Technical specification will vary as per project requirement



*Available against bulk orders only

X-RAY SHIELDING DOORS*



- 2mm lead layer to protect humans from hazardous X-rays.
- Rubber seal strips for hygienic requirements.
- SS 304 kick plate 150mm
- Provided with hand wave or foot sensor
- Round tube door handle
- Door filter rigid polyurethane

Hermetically Sealed & X-Ray Shielding Door Technical Parameters

DOOR PARAMETERS	HERMETICALLY SEALED DOOR	X-RAY SHIELDING DOOR
Maximum Door Weight	160kg / leaf	160kg / leaf
Door Width	1070mm to 1570mm	1070mm to 1570mm
Total Opening Width Required	2350mm to 3350mm	2350mm to 3350mm
Installation Possibility	Surface mounted	Surface mounted
Opening Speed	25-55cm/sec (Adjustable)	25-55cm/sec (Adjustable)
Closing Speed	25-55cm/sec (Adjustable)	25-55cm/sec (Adjustable)

*Available against bulk orders only



OVERHEAD DOOR CLOSERS



Finish : Silver

E Series



NSK-480E STD SILVER
SCREEN DOOR CLOSER

Rack and Pinion Overhead Door Closer with Adjustable closing force EN 1/2

- Maximum door weight: 25-45kg
- Finish: Silver



NSK-580-11 STD SILVER
OVERHEAD DOOR CLOSER (Scissors ARM)

Rack and Pinion Overhead Door Closer with Adjustable closing force EN 1/2

- Maximum door weight: 45kg
- Finish: Silver



Tested 500,000 Cycles



Weight Carrying Capacity

E Series



NSK-580E STD SILVER
OVERHEAD DOOR CLOSER (Scissors ARM)

Rack and Pinion Overhead Door Closer with Adjustable closing force EN 1/2

- Maximum door weight: 45kg
- Finish: Silver



Weight Carrying Capacity

E Series



NSK-640E STD SILVER
OVERHEAD DOOR (Scissors ARM)

Rack and Pinion Overhead Door Closer with Adjustable closing force EN 3

- Maximum door weight: 60kg
- Finish: Silver



Weight Carrying Capacity

WOODEN/FRAMED DOOR HARDWARE

Ozone offers a wide range of Tested & Certified Door Control Devices for all types of doors, be it glass, wood, or metal door. Apart from functional performance, every door hardware is designed to meet modern interiors aesthetic needs. With introduction of new Door Closers and Door Handles, the range is further strengthened to be more competent and offer numerous choices to the customers. Explore the range yourself to review the latest additions in the range.

OVERHEAD DOOR CLOSERS



NSK-680 STD SILVER
OVERHEAD DOOR CLOSER
(Scissors ARM)

Rack and Pinion Overhead Door Closer with Adjustable closing force EN 2-4
• Maximum door weight: 80kg
• Finish: Silver



EN 1154 Tested



Tested 500,000 Cycles

80 Kg



Weight Carrying Capacity



Scan QR for Installation Video



NSK-680 STD BM



NSK-680 STD ANTIQUE BRONZE

Power Adjustable



NSK-680A STD SILVER
OVERHEAD DOOR CLOSER (Scissors ARM)

Rack and Pinion Door Closer with Adjustable closing force EN 2-4
• Maximum door weight: 80kg
• Finish: Silver



EN 1154 Tested



Tested 500,000 Cycles

80 Kg



Weight Carrying Capacity



NSK-6825 STD SILVER
OVERHEAD DOOR CLOSER (Scissors ARM)

Rack and Pinion Door Closer with Selectable closing force EN 3-4
• Maximum door weight: 100kg
• Finish: Silver



EN 1154 Tested



Tested 500,000 Cycles

100 Kg



Weight Carrying Capacity



NSK-780 STD SILVER
OVERHEAD DOOR CLOSER
(Scissors ARM)

Rack & Pinion Door Closer with Adjustable closing force EN 2-5
• Maximum door weight upto 100kg
• Finish: Silver



EN 1154 Tested



Tested 500,000 Cycles

5 Years

WARRANTY

100 Kg



Weight Carrying Capacity



NSK-780 STD BM

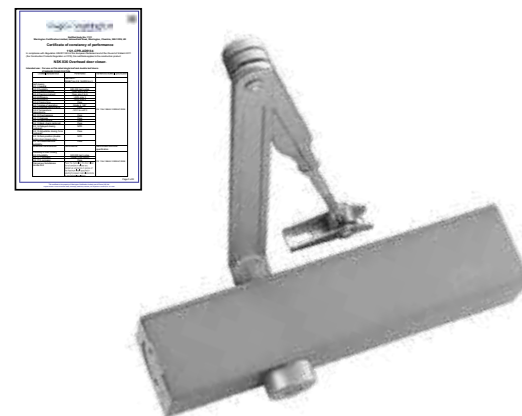

NSK-836 BC DA STD SILVER
OVERHEAD DOOR CLOSER (Scissors ARM)

Rack and Pinion Door Closer with Adjustable closing force EN 3-6
• Maximum door weight: upto 120kg
• Finish: Silver



EN 1154 Tested



Tested 500,000 Cycles

5 Years

WARRANTY

120 Kg



Weight Carrying Capacity



NSK-880 STD SILVER
OVERHEAD DOOR CLOSER (Scissors ARM)

Rack & Pinion Door Closer with Adjustable closing force EN 2/3/4/5
• Maximum door weight: 100Kg
• Finish: Silver



EN 1154 Tested



Tested 500,000 Cycles

10 Years

WARRANTY

100 Kg



Weight Carrying Capacity

OVERHEAD DOOR CLOSERS



NSK-980 E STD LIGHT GREY
OVERHEAD DOOR CLOSER (SCISSORS ARM)

Rack and Pinion Door Closer with Adjustable closing force EN 2-4
• Maximum door width: 1100mm
• Maximum door weight: 80Kg
• Finish: Light Grey



NSK-980E TA LIGHT-GREY
OVERHEAD DOOR CLOSER (TRACK ARM)

Rack and Pinion Door Closer with Hold Open Function and Adjustable closing force EN 2-4
• Maximum door weight: 80Kg
• Finish: Light Grey

80 Kg



Weight Carrying Capacity

80 Kg



Weight Carrying Capacity



NSK-980 TA SSS
OVERHEAD DOOR CLOSER (TRACK ARM)

Rack and Pinion Door Closer with Hold Open Function and Adjustable Closing Force EN 2-4
• Maximum door weight: 80Kg
• Finish: Silver



Tested 500,000 Cycles

80 Kg



Weight Carrying Capacity



NSK-CA-6800 .TA SSS
CAM ACTION OVERHEAD DOOR CLOSER
(TRACK ARM)

Overhead Cam Action Door Closer with Hold Open Function and Adjustable Closing Force EN 2-4
• Maximum door weight: upto 80kg
• Finish: Silver



EN 1154 Tested



Tested 500,000 Cycles

80 Kg



Weight Carrying Capacity

HOLD OPEN DOOR CLOSERS WITH SCISSORS ARM



NSK-680-HO STD SILVER
Rack & Pinion Door Closer with Adjustable closing force EN 2-4
• Maximum door weight: upto 80kg
• Finish: Silver



EN 1154 Tested



Tested 500,000 Cycles

80 Kg



Weight Carrying Capacity



NSK-780-HO STD SILVER
Rack & Pinion Door Closer with Adjustable closing force EN 2-5
• Maximum door weight: upto 100kg
• Finish: Silver



EN 1154 Tested



Tested 500,000 Cycles

100 Kg



Weight Carrying Capacity

5 Years

WARRANTY

Finish : Silver

OVERHEAD DOOR CLOSERS



NSK-6825-HO STD SILVER
Rack and Pinion Door Closer with Selectable closing force EN 3-4
• Maximum door weight: upto 100kg
• Finish: Silver



NSK-880-HO STD SILVER
Rack & Pinion Door Closer with Adjustable closing force EN 2/3/4/5
• Maximum door weight: upto 100kg
• Finish: Silver

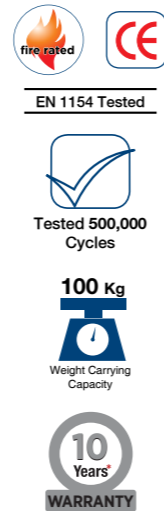

HOLD OPEN DOOR CLOSERS WITH TRACK ARM New



NSK-680-TR-HO STD SILVER
Rack And Pinion Overhead Door Closer with Hold Open Function and Adjustable Closing Force EN 2-4
• Maximum door weight: upto 80kg
• Finish: Silver

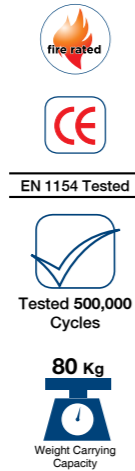

NSK-780-TR-HO STD SILVER
Rack And Pinion Overhead Door Closer with Hold Open Function and Adjustable Closing Force EN 2-5
• Maximum door weight: upto 100kg
• Finish: Silver



NSK-880-TR-HO STD SILVER
Rack And Pinion Door Closer with Hold Open Function and Adjustable Closing Force EN 2-5
• Maximum door weight: upto 100kg
• Finish: Silver



NSK-680E STD SILVER
Rack and Pinion Overhead Door Closer with Adjustable Closing Force EN 2-4 by Positioning Closing Force EN 2-4
• Minimum Door Thickness: 42mm
• Maximum door weight: upto 100kg
• Finish: Silver

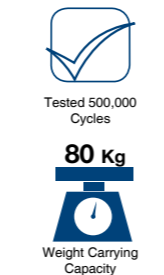

CONCEALED DOOR CLOSERS

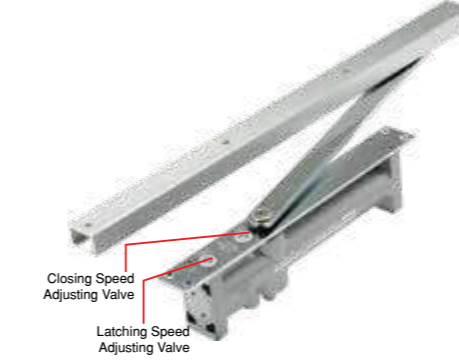

CDC-3800 TA SILVER
CONCEALED DOOR CLOSER
Concealed Rack & Pinion Door Closer with Hold Open Function and EN 3
• Minimum Door Thickness: 38mm



CDC-3800E TA GREY
CONCEALED DOOR CLOSER
Concealed Rack & Pinion Door Closer with Hold Open Function and EN 3
• Minimum Door Thickness: 38mm
• Maximum door weight: 60kg
• Finish: Grey



Power Adjustable with Back Check

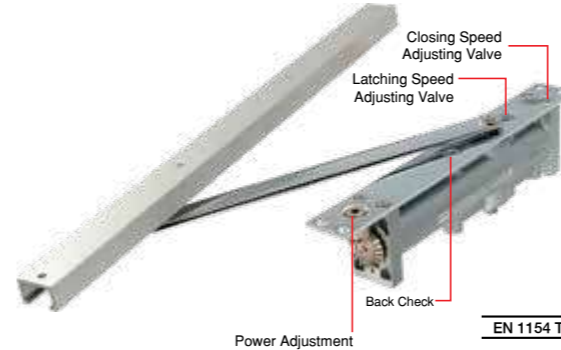

CDC-4800 TA SILVER
Concealed Rack & Pinion Door Closer with Hold Open Function and Adjustable Closing Force EN 2-4
• Minimum Door Thickness: 42mm
• Maximum door weight: upto 100kg
• Finish: Silver



Power Adjustable

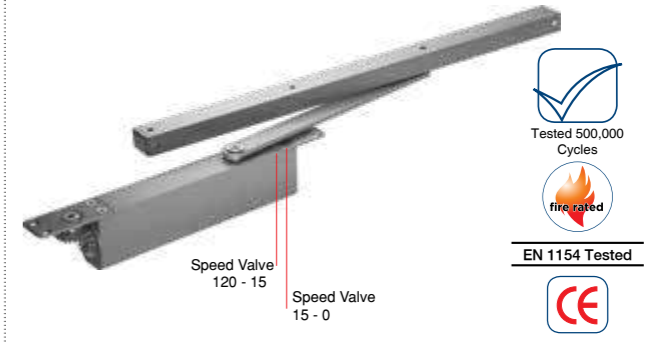

CDC-CA-6800 TA SILVER
Cam Action Concealed Door Closer with Hold Open Function and Adjustable Closing Force EN 2-4
• Minimum Door Thickness: 41mm
• Maximum door weight: 120kg
• Finish: Silver



CDC-3800-SL STD SILVER
Concealed Rack & Pinion Door Closer with Hold Open Function and Adjustable Closing Force EN 2-4
• Minimum Door Thickness: 32mm
• Maximum door weight: upto 60kg
• Finish: Silver

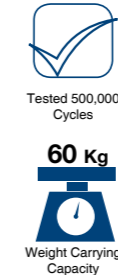

CDC-CA-6800-SL STD SILVER
Cam Action Concealed Door Closer with Hold Open Function and Adjustable Closing Force EN 2-4
• Minimum Door Thickness: 40mm
• Maximum door weight: upto 100kg
• Finish: Silver

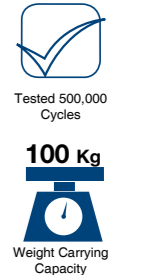

OVERHEAD DOOR CLOSERS



OZ-SD-DC-60 STD SILVER
Rack & Pinion Door Closer with adjustable closing force EN 1-3

- Mounting – Door leaf
- Adjustable closing speed
- Latching Speed
- Finish: Silver

CE
EN 1-3 Tested
Tested 100,000 Cycles
Door Width 950mm
60 Kg Weight Carrying Capacity



OZ-SD-DC-NEO-60 SILVER
Rack & Pinion Door Closer with adjustable closing force EN 1-3

- Mounting – Door leaf
- Adjustable closing speed
- Latching Speed
- Finish: Silver

CE
EN 1-3 Tested
Tested 100,000 Cycles
Door Width 950mm
60 Kg Weight Carrying Capacity



NSK-CA-6800-2W TA SSS
Overhead Cam Action Door Closer with adjustable closing force EN 2-4

- Inward and outward movement
- Easy opening action
- Power adjustable
- Adjustable closing speed in two independent ranges
- Test certificate available on request
- Finish: Silver

fire rated
EN 1154 Tested
CE
Tested 500,000 Cycles
Door Width 1100mm
80 Kg Weight Carrying Capacity



OZ-SD-DC-NEO-60 TA SILVER
Rack & Pinion Door Closer with adjustable closing force EN 1-3

- Mounting – Door leaf
- Adjustable closing speed
- Latching Speed
- Finish: Silver

CE
EN 1-3 Tested
Tested 100,000 Cycles
Door Width 950mm
60 Kg Weight Carrying Capacity

ELECTROMAGNETIC DOOR CLOSERS

Available against bulk orders only



NSK-980-EMHO-SA
Door Closer with Electromagnetic Hold Open Scissors Arm
Finish: SSS



NSK-980-EMHO-SA-S
Door Closer with Electromagnetic Hold Open Scissors Arm and Smoke Detector
Finish: SSS



NSK-980-EMHO-TA STD SS
Door Closer with Electromagnetic Hold Open Track Arm
Finish: SSS



NSK-980-EMHO-TA-S STD SS
Door Closer with Electromagnetic Hold Open Track Arm and Smoke Detector
Finish: SSS

DOOR CLOSERS WITH MOUNTING PLATE FOR GLASS DOORS



NSK-780 STD SILVER
Rack & Pinion Door Closer with Adjustable closing force EN 2-5

100Kg Weight Carrying Capacity
fire rated
CE
5 Years WARRANTY
Tested 500,000 Cycles



NSK-780 STD BM



NSK-980 E STD Light Grey
Overhead Door Closer (Scissors Arm)

80Kg Weight Carrying Capacity
E Series



NSK-780-TR-HO STD SILVER
Rack & Pinion Door Closer with Hold Open Function and Adjustable closing force EN 2-5

100Kg Weight Carrying Capacity
fire rated
CE
5 Years WARRANTY
Tested 500,000 Cycles
EN 1154 Tested



NSK-980 SSS
Overhead Door Closer with Hold Open Function and Track Arm

UL
Tested 500,000 Cycles
80 Kg Weight Carrying Capacity



NSK-980 E TA Light Grey
Rack and Pinion Door Closer with Hold Open Function and Adjustable closing force EN 2-4

80Kg Weight Carrying Capacity
UL
CE
Tested 500,000 Cycles



NSK-980 E TA BM



NSK-ACC-780 PLATE STD SILVER
Mounting Plate for Glass Door Installation of Door Closer NSK 780



NSK-ACC-780 PLATE STD BM



NSK-ACC-980-PLATE STD SILVER
Mounting Plate for Glass Door Installation of Door Closer NSK 980



NSK-ACC-980 PLATE STD BM



OZ-PGDH STD SSS
Pivot Hinge Set



OZ-PGDH STD BM



OGC-DH-2 STD SSS
Frame Rebate Mounting Hinge (Square)



OGC-DH-2 STD BM

FLOOR SPRING

FS-8400 STD SSS

Cam Action Floor Spring with Closing Force EN3
Double Cylinder (Heavy Duty)

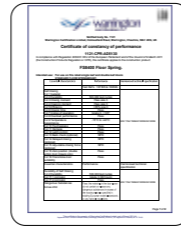

- Maximum door weight **80kg**
- Tested to: 5,00,000 cycles



FS-8300 STD SSS

Double Cylinder Floor Spring with Cam Action Force
EN3 for better performance on internal low traffic doors



- Maximum door weight **80kg**
- Tested to: 5,00,000 cycles



FS-8400 w/o HO STD STD*

Cam Action Floor Spring with Closing Force EN3
Double Cylinder (Heavy Duty)



- Maximum door weight **80kg**
- Tested to: 5,00,000 cycles

*Against on request

EN 1154 Tested



FLOOR SPRING

FS-8400-S STD SSS

Cam Action with Closing Force EN3
Double Cylinder with Stronger Spring Inside



EN 1154 Tested



Installation Video

- Super Spring (stronger spring inside)
- Maximum door weight **80kg**
- Tested to : **10,00,000 cycles**



FS-8400-S STD BM FS-8400-S STD GOLD M-PVD FS-8400-S STD ANTIQUE BRONZE

FS-9000 STD SSS

Cam Action Floor Spring with Closing Force EN4
Double Cylinder (Heavy Duty)



EN 1154 Tested

- Maximum door weight **120kg**
- Tested to: 5,00,000 cycles



FS-9400 STD SSS

Cam Action Floor Spring with Closing Force EN4
Double Cylinder (Heavy Duty)



- Maximum door weight **150kg**
- Tested to: 5,00,000 cycles

EN 1154 Tested



FLOOR SPRING

FS-10400 STD STD
Cam Action Floor Spring with Closing Force EN4
Double Cylinder (Heavy Duty)



- Maximum door weight **270kg**
- Tested to: 5,00,000 cycles

EN 1154 Tested

270 Kg
Weight Carrying Capacity

3 Years
WARRANTY

FS-11400 STD STD
Power Adjustable Floor Spring for Heavy Wooden / Glass Doors
Ideal for Banquet Halls, EN 2-6



- Door weight range **65kg-200kg**
- Power adjustable

65-200 Kg
Weight Carrying Capacity

3 Years
WARRANTY

FLOOR SPRING

OFS-6400SD+ STD SSS
Single Cylinder Floor Spring for Glass Doors, EN3



Set includes: Floor Spring, Top Patch & Bottom Patch
Maximum door weight **70kg**

70 Kg
Weight Carrying Capacity



Product Set includes

*Patch fittings will not be sold individually



OPF-2 SD Top Patch



OPF-3 SD Bottom Patch

OFS-6400-TPBPE1 STD STD
Single Cylinder Floor Spring for Wood/Aluminium/Framed Doors, EN2



Product Set includes Top & Bottom Pivot for Wooden & Aluminium Door



High and Low Adjustment Screw

70 Kg
Weight Carrying Capacity

OFH-5500E-TPBPE1 STD STD
Single Cylinder Floor Spring for Wood/Aluminium/Framed Doors, EN2



Product Set includes Top & Bottom Pivot for Wooden & Aluminium Door



Maximum door weight **45kg**



High and Low Adjustment Screw

45 Kg
Weight Carrying Capacity

OFS-5800SD STD STD
Single Cylinder Floor Spring for Small Glass Doors, EN3



Product Set includes



OPF-2 SD Top Patch



OPF-3 SD Bottom Patch

*Patch fittings will not be sold individually.

Set includes: Floor Spring, Top Patch & Bottom Patch
• Maximum door weight **55kg**

55 Kg
Weight Carrying Capacity

OFH-6600-E STD SSS
Single Cylinder Floor Spring for Wood/Aluminium/Glass Doors, EN4



with up & down Adjustment



OFH-6600-E STD BM

Maximum door weight **85kg**

85 Kg
Weight Carrying Capacity

FLOOR SPRING ACCESSORIES

Finish : SSS & Black Matt



OFS-ACC-TPBE1 STD SSS
Top & Bottom Pivot for
Wooden/Aluminium Door



OFS-ACC-OP-L/R SS
Offset Pivot Set for
Wooden/Aluminium Doors



OFS-ACC-TP/BP STD SSS
Top & Bottom Pivot
for Wooden/Aluminium Door



OFS-ACC-MH1 STD SS
Mini Floor Hinge Compatible
with Patch Fittings



OFS-ACC-PH-TP/BP*
Top & Bottom Pivot for Wooden/
Aluminium Door



*Available on request

OFS-ACC-GDP SS
Top Pivot for Patch/Point
Fitting Doors



TRANSOM CLOSERS

OTC-7400 STD STD
Transom Mounted Door Closer



- Specifications**
**Cam action transom door closer
with closing force EN 2**
- Maximum opening angle 130 both sides
 - Maximum door weight 70Kg
 - Maximum door width 850mm
 - Suitable for framed door



OTC-8400 STD STD
Transom Mounted Door Closer



- Specifications**
**Cam action transom door closer
with closing force EN 3**
- Maximum opening angle 130 both sides
 - Maximum door weight 105Kg
 - Maximum door width 950mm
 - Suitable for framed door



ACCESSORIES for Transom Mounted Closers (Part of Standard Package)



Bottom Pivot with
Bearing



Mounting Bracket for Transom Closer
at Spindle Side



Mounting Bracket for
Transom Closer at the end



Arm to accept Transom
Closer Spindle to be mounted
into the channel on door top &
secure with blanking tape



Finish : SSS



**THE ORIGINAL SELF CLOSING PATCH FITTING
FOR WOODEN DOORS**



Specifications:

- Quick and easy installation
- Suitable door weight: Maximum 100kg
- Hold Open at 90
- Material: SS 304



Standard packing includes
top pivot set



EN 1154 Tested

**THE ORIGINAL SELF CLOSING PATCH FITTING
OCFH-W-100 STD SSS**

- Suitable door width: 950mm
- Suitable door thickness: >40mm
- Suitable for Internal Doors with Power Size 3
- Standard package comes along with Top Pivot set

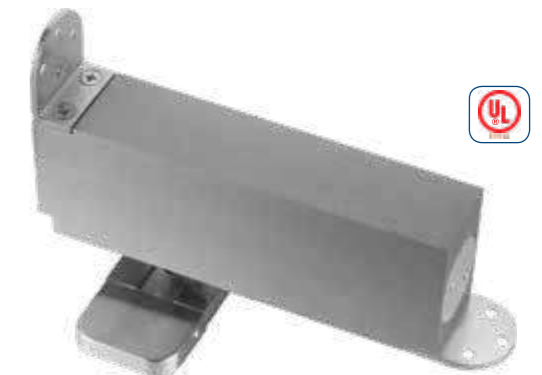

**THE ORIGINAL SELF CLOSING PATCH FITTING
OCFH-W-105 STD SSS**

- Suitable door width: 1250mm
- Suitable door thickness: >50mm
- Suitable for External Doors with Power Size 5

CONTRACTOR KY SERIES - OCX.KY

Finish : CP/SN



OCX.KY1.STD CP/SN
Material : Zinc Alloy
Finish : CP/SN



OCX.KY2.STD CP/SN
Material : Zinc Alloy
Finish : CP/SN



OCX.KY3.STD CP/SN
Material : Zinc Alloy
Finish : CP/SN



OCX.KY4.STD CP/SN
Material : Zinc Alloy
Finish : CP/SN



OCX.KY5.STD CP/SN
Material : Zinc Alloy
Finish : CP/SN

CONTRACTOR BT SERIES - OCX.BT
(Suitable for Bathroom Doors)

Finish : CP/SN



OCX.BT1 STD CP/SN*
Handle set with Baby Latch
Finish : CP/SN



OCX.BT2 STD CP/SN*
Handle Set with Baby Latch
Material : Zinc Alloy
Finish : CP/SN



OCX.BT3 STD CP/SN*
Handle set with Baby Latch
Finish : CP/SN



OCX.BT4 STD CP/SN*
Handle set with Baby Latch
Finish : CP/SN



OCX.BT5 STD SN
Handle set with Baby Latch
Finish : SN

*Available on request

CONTRACTOR PRO SERIES - OCXP

Finish : CP/SN



OCXP.001.K60 RS CP/SN
OCXP.001.N60 RS CP/SN
OCXP.001.K70 RS CP/SN
OCXP.001.N70 RS CP/SN
Kit Includes: Handle set, Mortise Lock Body, & Euro Profile Cylinder
Material : Zinc Alloy
Finish : CP/SN



OCXP.001.K60 8" CP/SN
OCXP.001.N60 8" CP/SN
OCXP.001.K70 8" CP/SN
OCXP.001.N70 8" CP/SN
Kit Includes: Handle set, Mortise Lock Body, & Euro Profile Cylinder
Material : Zinc Alloy
Finish : CP/SN



OCXP.002.K60 RS CP/SN
OCXP.002.N60 RS CP/SN
OCXP.002.K70 RS CP/SN
OCXP.002.N70 RS CP/SN
Kit Includes: Handle set, Mortise Lock Body, & Euro Profile Cylinder
Material : Zinc Alloy
Finish : CP/SN



OCXP.002.K60 8" CP/SN
OCXP.002.N60 8" CP/SN
OCXP.002.K70 8" CP/SN
OCXP.002.N70 8" CP/SN
Kit Includes: Handle set, Mortise Lock Body, & Euro Profile Cylinder
Material : Zinc Alloy
Finish : CP/SN



OCXP.002.K60 10" CP/SN
OCXP.002.N60 10" CP/SN
OCXP.002.K70 10" CP/SN
OCXP.002.N70 10" CP/SN
Kit Includes: Handle set, Mortise Lock Body, & Euro Profile Cylinder
Material : Zinc Alloy
Finish : CP/SN



OCXP.002.K60 ME CP/SN*
Kit Includes: Pull handle, Rose handle, Lock body, & Cylinder

PREMIUM SERIES - OPX

Finish : CP/SN



OPX.002.PL 10" CP/SN*
Pull Handle 10"



OCXP.002.PL 10" CP/SN*
Pull Handle 10"



OPX.001 RS CP/SN
Handle with Square Rose
Material : Zinc Alloy
Finish: CP/SN



OPX.002 RS CP/SN
Handle with Square Rose
Material : Zinc Alloy
Finish: CP/SN

*Available on request

CONTRACTOR SERIES - OCX

Finish : CP/SN



OCX.001.K60 8" CP/SN
OCX.001.N60 8" CP/SN
OCX.001.K70 8" CP/SN
OCX.001.N70 8" CP/SN
 Kit Includes: Handle set, Mortise Lock Body, & Euro Profile Cylinder
 Material : Stainless Steel & Zinc Alloy
 Finish : CP/SN



OCX.001.K60 10" CP/SN
OCX.001.N60 10" CP/SN
OCX.001.K70 10" CP/SN
OCX.001.N70 10" CP/SN
 Kit Includes: Handle set, Mortise Lock Body, & Euro Profile Cylinder
 Material : Stainless Steel & Zinc Alloy
 Finish : CP/SN



OCX.004.K60 RS SN
OCX.004.N60 RS SN
OCX.004.K70 RS SN
OCX.004.N70 RS SN
 Kit Includes: Handle set, Mortise Lock Body, & Euro Profile Cylinder
 Material : Zinc Alloy
 Finish : SN

INOX SERIES - Solid Casted

Finish : SSS



OMH-11C STD SSS
 Mortise Handle in SSS Finish
 Material : Stainless Steel
 Grade : 304
 Finish : SSS



OMH-22C STD SSS
 Mortise Handle in SSS Finish
 Material : Stainless Steel
 Grade : 304
 Finish : SSS



***OMH-33C STD SSS**
 Mortise Handle in SSS Finish
 Material : Stainless Steel
 Grade : 304
 Finish : SSS



***OMH-44C STD SSS**
 Lever Handle in SSS Finish



OCX.006.K60 8" CP/SN
OCX.006.N60 8" CP/SN
OCX.006.K70 8" CP/SN
OCX.006.N70 8" CP/SN
 Kit Includes: Handle set, Mortise Lock Body, & Euro Profile Cylinder
 Material : Zinc Alloy
 Finish : CP/SN



OCX.006.K60 RS CP/SN
OCX.006.N60 RS CP/SN
 Kit Includes: Handle set, Mortise Lock Body, & Euro Profile Cylinder
 Material : Zinc Alloy
 Finish : CP/SN



OCX.008.K60 8" SN
OCX.008.N60 8" SN
OCX.008.K60 10" SN
OCX.008.N60 10" SN
 Kit Includes: Handle set, Mortise Lock Body, & Euro Profile Cylinder
 Material : Zinc Alloy
 Finish : SN



***OCX.004.K70 8" SN**
***OCX.004.N60 8" SN**
 Kit Includes :Handle set, Lock Body, & Cylinder



***OCX.004.K70 10" SN**
***OCX.004.N60 10" SN**
 Kit Includes :10" Handle, Lock Body, & Cylinder

*Available on request



TUBULAR MORTISE HANDLES - OMH

Finish : SSS/PSS & Black Matt



OMH-11N STD SSS/PSS
L-shape Mortise Handle in SSS Finish
Material : Stainless Steel
Grade : 304
Finish : PSS/SSS



OMH-33N STD SSS

OMH-33N STD SSS
Mortise Handle for Narrow Style Doors
Material : Stainless Steel
Grade : 304
Finish : SSS



OMH-11LN STD SSS

OMH-11LN STD SSS
Mortise Handle for Narrow Style Doors
Material : Stainless Steel
Grade : 304
Finish : SSS



OMH-11 STD SSS
Tubular Mortise Handle in SSS Finish
Material : Stainless Steel
Grade : 304
Finish : SSS



OMH-11 19mm STD SSS
Tubular Mortise Handle in SSS Finish
Material : Stainless Steel
Grade : 304
Finish : SSS



OMH-11L STD SSS
Mortise Handle in SSS Finish
Material : Stainless Steel
Grade : 304
Finish : SSS



OMH-33 STD SSS
D-Type Mortise Handle
Material : Stainless Steel
Grade : 304
Finish : SSS



OMH-33P STD SSS
D-Type Mortise Handle with Plate
Material : Stainless Steel
Grade : 304
Finish : SSS



OMH-44 STD SSS
Mortise Handle in SSS Finish
Material : Stainless Steel
Grade : 304
Finish : SSS



OMH-55 STD SSS
Mortise Handle in SSS Finish
Material : Stainless Steel
Grade : 304
Finish : SSS



OPKL-K2N-STD SSS
Mortise Handle with POD Lock in SSS Finish
Material : Stainless Steel
Finish : SSS



OPKL-K2N-C STD SSS
Mortise Handle with POD Lock in SSS Finish
Material : Stainless Steel
Finish : SSS



OPKL-B2N-C STD SSS
Mortise Handle with POD Lock in SSS Finish
Material : Stainless Steel
Finish : SSS

MORTISE LOCK BODY

SASH LOCK FOR REBATED DOORS



OML-11A-F 45/85 SSS
OML-11A-F 55/72 SSS
Mortise Lock Body Fire Rated with Dead Bolt & Latch Bolt



OML-11-E 50x50MM CP
Closed Body Mortise Lock with Dead Bolt & Latch Bolt
Suitable to use with 8" Plate Handles



OML-DD-R 50x85MM SSS
OML-DD-L 50x85MM SSS
Mortise Lock Body with Latch Bolt & Dead Bolt for Wooden Double Doors



OML-33A 35x85MM SSS
Narrow Style Lock Body for Aluminium Doors with Latch & Dead Bolt
Finish: SS & BM



OML-11A 45x85 MM SSS
Closed Body Mortise Lock with Strike Plate, Double Throw (SS-304) Dead Bolt & Latch Bolt (SS-304)



OML-11-E2 45x85 SSS
Closed Body Mortise Lock with Dead Bolt & Latch Bolt
Finish: SN/BM/AB

NARROW MORTISE SASH LOCK



OML-33 55/72 MM SSS
Fire Rated Mortise Lock Body with Deadbolt & Latch bolt



OZML-DL1-25MM SSS
Narrow Style Mortise Lock Body with Dead Bolt (Also Suitable for Aluminium Framed Doors)

Finish : SSS, CP & Black Matt



OML-22A-4P-55x85 Std
Mortise Lock Body with Double Throw Four Dead Bolts & Latch Bolt



OML-11 60x85mm SSS
Closed Body Mortise Lock with Dead Bolt & Latch Bolt



OML-33A 30x85MM SSS
Narrow Style Mortise Lock Body for Aluminium Doors with Latch & Dead Bolt
Finish: SS & BM

MORTISE LOCK BODY

DEAD LOCK



OZML-DL1 55MM SSS
Closed Body Mortise Lock with Strike Plate,
Double Throw Dead Bolt



OZML-DL1-F 55MM SSS
Close Body Mortise Lock with Strike
Plate, Double Throw Dead Bolt



OZML-DL1-E 50MM SSS
Closed Body Mortise
Lock with Strike Plate, Double Throw Dead Bolt

ROLLER LATCH



OML-44-RL 60x85mm SSS
Roller Lock Body

SHAFT LOCK



OML-SL-STD SSS
Mortise Lock Body with
Dead Bolt, operated with
Allen Key

LATCH LOCK



OZML-L1-E-O 46.5MM SSS
Mortise Lock Body with Soft
Closing Latch Bolt

Finish : SN & Black Matt

EURO PROFILE CYLINDERS FOR MORTISE LOCKS

DEFEND PRO SERIES

Single Security Computerized Key System

Master & Grand Master Key Available



OMC-11-K2K-P-60MM SN
OMC-11-K2K-P-70MM SN
OMC-11-K2K-P-80MM SN
Both Side Keys
Finish: SN/ BM



OMC-11-K2N-P-60MM SN
OMC-11-K2N-P-70MM SN
OMC-11-K2N-P-80MM SN
One Side Key One Side Knob
Finish: SN/ BM



OML-CPP STD SSS
Cylinder Pull Plate
Finish: SSS

DEFEND SERIES - Normal Key

Master & Grand Master Key Available



OMC-22-HC-KNOB-N-45MM SN
Half Cylinder with Knob
Finish: SN



OMC-22-HC-KEY-N-45MM SN
Half Cylinder with
3 Brass Normal Keys
Finish: SN



OMC-22-K2K-N 60MM SN
OMC-22-K2K-N 70MM SN
OMC-22-K2K-N 80MM SN
Both Side Keys
Finish: BM

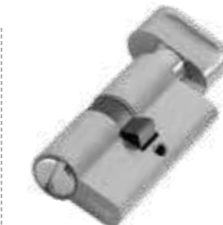

OMC-22-BT-N 60MM SN
OMC-22-BT-N 70MM SN
OMC-22-BT-N 80MM SN
Bathroom Type
Finish: SN/BM



OMC-22-K2N-N 60MM SN
OMC-22-K2N-N 70MM SN
OMC-22-K2N-N 80MM SN
OMC-22-K2N-N 90MM SN
One Side Key One Side Knob
Finish: SN/BM



OMC-22E-K2K 60MM SN
OMC-22E-K2K 70MM SN
Finish: SN/BM/AB

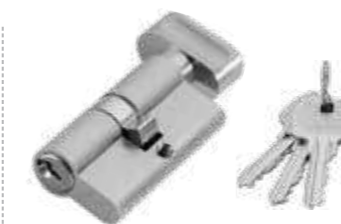

OMC-22E-K2N 60MM SN
OMC-22E-K2N 70MM SN
Finish: SN/BM/AB



OMC-22E-BT-N 60MM SN
Finish: SN/BM/AB

NIGHT LATCH LOCKS

Features:

- High strength latch bolt/ dead bolt
- Safety knob ensures the security and privacy
- Restrict unauthorised access from outside



OZ-NL-11R STD AB
OZ-NL-11L STD AB
Mini Latch

- Night latch for inside opening doors
- Right & left handed
- High security 3 brass keys



OZ-NL-33 STD AB
Night Latch (Single Latch+ Double Bolt)

- Reversible latch bolt
- Double dead bolt with double stroke
- Reversible computerized keys - 4nos. (Brass)
- Suitable for inside/outside opening doors

GRILL AND DOOR LOCKS



OZ-NL-55 STD AB
Interlock with 3 Stroke

- Dead bolt option available after shifting latch upwards
- Single sliding bolt with 3 stroke
- Reversible computerized keys - 4nos. (Brass)
- Door thickness:- 40mm

Suitable for:

- Wooden or metal doors
- Single or double doors
- Door Thickness: 30-70mm
- Locking from outside by key, inside by knob



OZ-NL-22 STD AB
Night Latch

- Reversible latch bolt
- Double stroke dead bolt
- Reversible computerized Key - 4nos. (Brass)
- Suitable for inside/outside opening doors
- Holdback feature prevents any lockout situations



OZ-NL-44 STD AB
Tri Bolt Night Latch

- Three strong bolt for triple bolt security
- No fear of accidental locking
- Dead bolts with double stroke
- Reversible computerized keys - 4nos. (Brass)
- Suitable for inside/outside opening doors



OZ-NL-66 STD AB
Interlock with 6 Stroke



Finish : AB/SSS



Watch Video



Watch Video



Watch Video

NIGHT LATCH LOCKS

Features:

- High strength latch bolt/ dead bolt
- Safety knob ensures the security and privacy
- Restrict unauthorised access from outside



OZ-NL-11R STD SSS
OZ-NL-11L STD SSS
Mini Latch

- Night latch for inside opening doors
- Right & left handed
- High security 3 brass keys



OZ-NL-44 STD SSS
Tri Bolt Night Latch

- Three strong bolt for triple bolt security
- No fear of accidental locking
- Dead bolts with double stroke
- Reversible computerized keys - 4nos. (brass)
- Suitable for inside/outside opening doors



Watch Video

CYLINDRICAL KNOB LOCKS

(Available in 60MM & 70MM Backset)

Finish : SSS



OCKL-11N 60mm STD SSS
OCKL-11N 70mm SSS
Knob Lock with Key
Operation & Push Button



OCKL-22N 60mm STD SSS
OCKL-22N 70mm SSS
Knob Lock with Push
Button & Coin Release



OCKL-33N 60mm STD SSS
OCKL-33N 70mm SSS
Knob Lock with both
side Active Knobs



OZ-NL-22 STD SSS
Night Latch

- Reversible latch bolt
- Double stroke dead bolt
- Reversible computerized Key - 4nos. (Brass)
- Suitable for inside/outside opening doors
- Holdback feature prevents any lockout situations



Watch Video



OZ-NL-33 STD SSS
Night Latch (Single Latch+ Double Bolt)

- Reversible latch bolt
- Double dead bolt with double stroke
- Reversible computerized keys - 4nos.(Brass)
- Suitable for inside/outside opening doors



OZ-NL-66 STD SSS
Interlock with 6 Stroke

GRILL AND DOOR LOCKS



OZ-NL-55 STD SSS
Interlock with 3 Stroke

- Dead bolt option available after shifting latch upwards
- Single sliding bolt with 3 stroke
- Reversible computerized keys - 4nos. (Brass)
- Door thickness:- 40mm



Watch Video

PANIC DOOR HARDWARE

Finish : SSS



1 Point Modular
Push Panic Bar for Single Door

OZ-PB-TCR-F-842MM SSS
Maximum Door Width : Upto 1100

OZ-PB-TCR-F-1020MM SSS
Maximum Door Width : Upto 1400

Features :

- Push bar for fire and smoke check doors
- Stainless steel latch and security anti-thrust latch
- Certified as per UL 10C 1-3 HOURS FIRE RATED
 - For Hollow Metal Door: 3 Hours Fire Rated
 - For Wooden Door: 1.5 Hours Fire Rated



2 Point Modular
Push Panic Bar for Double Door

OZ-PB-TCV-F-842MM SSS
Maximum Door Width : 1100/2400

OZ-PB-TCV-F-1020MM SSS
Maximum Door Width : 1400/2400

Accessories



OZ-PB-TCTRIM-F-STD SSS
External Trim



OZ-PBV-DLS-Std
Overlapping Cover
Strike Plate

FIRE RATED CROSS PUSH PANIC BAR

Finish : SSS



OZ-PB-CRV-F-900mm Silver
Maximum Door Width: Upto 1200
Door Height 2300mm

Features :

- Cross bar for fire and smoke check doors
- 3 hour fire certified
- Suitable for door Thickness 40-60mm
- Connecting rod length: 900mm
- Compatible with external trim
OZ-PB- CRTRIM-F-STD Silver

Accessory



OZ-PB-CRTRIM-F-N STD Silver
External Trim Handle



OZ-PB-CRR-F-900mm Silver
Maximum Door Width : Upto 1200
Door Height 2300mm

Features :

- Cross bar for fire and smoke check doors
- 3 hours fire certified
- Suitable for door Thickness 40-60mm
- Connecting rod length: 900mm
- Compatible with external trim
OZ-PB- CRTRIM-F-STD Silver

Features :

- Rectangular External Trim with lever handle for fire and smoke check doors
- 3 hour fire certified
- EN-1634-1:2008
- Maximum Door Thickness: 75mm
- Aluminum material grade
- Powder Coated finish
- Solid Square Spindle
- Master Key available on request Replaceable EP Cylinder with one side key operation
- Ideal for emergency exit of metal/Wooden single/double door

GRAVITY DOOR COORDINATOR



OZ-GDC STD SILVER
For sequencing door closing action



OZ-GDC-F-STD SILVER
For sequencing door closing action



Watch Video

Features

- Sequences the Door Closing i.e. roller arm stops active door from closing before the inactive door
- Gravity action arm and door bracket are adjustable on the jamb for ease of installation
- Nylon roller to enable the inactive door to easily operate

Specifications:

- Device: Non-handed & reversible
- Projection: 6-1/2"
- Material: Forged brass with nylon roller
- Finish: Satin chrome

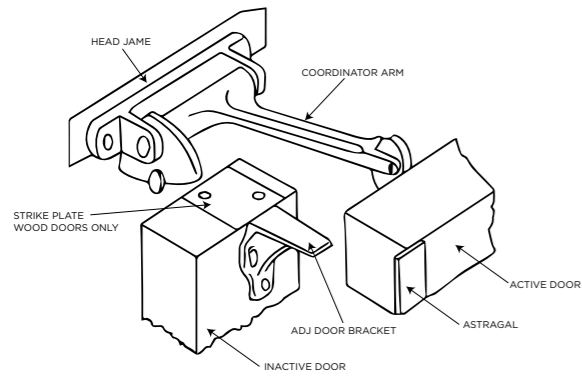

OZ-PB-CRTRIM-H STD SILVER
External trim handle for panic bar

Features

- Rectangular external trim with lever handle for fire and smoke check doors
- Aluminum material grade
- Powder coated finish
- Solid square spindle
- Master key available on request replaceable EP cylinder with one side key operation

Applications

- Ideal for metal and wooden single/double leaf emergency exit doors



3 hours
Fire Certified

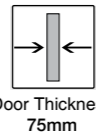

Door Thickness
75mm

DOOR GUARD & STOPPER



OZ-DG-B-11-E STD SN
Door Guard Buckle Type



OZ-DG-B-11 STD SN
Door Guard Buckle Type



OZ-DG-22 STD SN
Door Chain



OZ-DST-11 STD SN
Door Stopper



OZ-DST-22 STD SN
Door Stopper



OZ-WST-11 STD SSS
Wall Mounted
Door Stopper



**OZ-DST-33F-N
STD SS**
Door Stopper



OZ-DST-44M STD SS
Magnetic Door
Stopper for Wooden
Doors



OZ-DST-55E STD SN
Door Stopper for
Wooden & Framed
Doors



OZ-MC Std Std
Magnetic Door
Catcher for Cabinets

***OWDS-11 900MM AN
OWDS-11 1Mtr AN**
Drop Down Seal



*against on request

**OZ-DE-1 25MM SS
OZ-DE-1 25MM BM**
180° Door Viewer



**OZ-DE-1-E 16MM SS
OZ-DE-1-E 16MM BM**
180° Door Viewer



OZ-CFB-DP 300MM SSS
Concealed Flush Bolt

ESCUTCHEON WITH KNOBS

Finish : SSS



OML-LR STD SSS
Round Escutcheon



OML-N-LR STD SSS
Narrow Escutcheon



OIL-R STD SSS
Escutcheon with knob &
occupied indicator for OML-11BT



OIL-S STD SSS
Escutcheon with knob & occupied
indicator for OML-11BT

*Available on request

FOOT PLATE FOR TOUCH-LESS DOOR ACCESS

Finish : SSS



OZ-FP-01
Foot Plate



Specifications:

- Suitable to use on wooden, steel, and aluminium framed doors
- Prevents spread of germs
- Maximum door load capacity: 80kg
- Finish: SSS
- SS 304 Grade Material
- Dimensions (mm): 70(L) x 100(W) x 3(Th)

ALDROP

Finish : PSS/SSS

Available against bulk orders only



OZ-ALD-03 16*300mm
Finish: SSS



OZ-ALD-01 16*200mm
OZ-ALD-02 16*250mm
Finish: SSS

TOWER BOLTS

Finish : PSS/SSS

STANDARD TYPE



Standard Sizes

E Series	
Grade: SS 304	Grade: SS 202
OZ-TB-S 12" SSS	OZ-TB-SE 12" SSS
OZ-TB-S 10" SSS	OZ-TB-SE 10" SSS
OZ-TB-S 8" SSS	OZ-TB-SE 8" SSS
OZ-TB-S 6" SSS	OZ-TB-SE 6" SSS
OZ-TB-S 4" SSS	OZ-TB-SE 4" SSS
Finish: SSS	Finish: SSS

Also available in **PSS/SSS** finish with **SS 304** Grade

OZ-TB-S 18" SSS & OZ-TB-S 24" SSS available on request
OZ-TB-SE 18" SSS & OZ-TB-SE 24" SSS available on request

SQUARE TYPE



Standard Sizes

SS 304-SSS
OZ-TB-S11 12" SSS
OZ-TB-S11 10" SSS
OZ-TB-S11 8" SSS
OZ-TB-S11 6" SSS
OZ-TB-S11 4" SSS

OZ-TB-S11 18" SSS & OZ-TB-S11 24" SSS available on request

CENTRAL PIVOT HINGE FOR WOODEN DOOR



Features

- 360° rotation
- Free rotate inside or outside
- Equal opening on both side of axis
- Hold open at 90°
- Concealed Hardware

Specifications

- Weight carrying capacity upto 200kg
- Door width 2500mm
- Suitable door thickness 50mm
- Angle of opening 360°
- Closing speed adjustment
- Latching speed adjustment
- Hold-Open feature



OCFH-RD-W 200kg SSS

ADJUSTABLE 3D INVISIO HINGE

Available Finishes
Silver Black Matt Champagne Gold G-PVD



Product Image							
Product Code	Oz-InvH-40 Std	Oz-InvH-60 Std	Oz-InvH-80 Std	Oz-InvH-100F Std*	Oz-InvH-120 Std*	Oz-InvH-150F Std	Oz-InvH-200F Std
Fire Rated	No	No	No	Yes	No	Yes	Yes
Weight Per Pair (KG)	40kg	60kg	80kg	100kg	120kg	150kg	200kg
Minimum Door Thickness	40mm	35mm	30mm	40mm	40mm	40mm	40mm
Max Door Width	900mm	900mm	900mm	900mm	940mm	900mm	900mm

STAINLESS STEEL FLAP HINGES



OZ-2BB-FP 5x3x3 SSS
OZ-2BB-FP 5x3x3 BM
OZ-2BB-FP 4x3x3 SSS
OZ-2BB-FP 4x3x3 BM



OZ-2BB-FP-SL 5x3x3 SSS
OZ-2BB-FP-SL 5x3x3 BM



SS BUTT HINGES

*With Fixing Screws For Wooden Doors

Finish : SSS

SS Butt Hinges with Four Ball Bearings*

SS-304



OZ-SSBH 4x3x2.5MM SSS



OZ-SSBH 4x3x3MM SSS



OZ-SSBH 5x3x3MM SSS



OZ-SS BH 4x3x2.5MM SSS

SS Butt Hinges with Two Ball Bearings*

SS-304



OZ-BH-2BB
4x3x2.5MM SSS



OZ-BHF-2BB-Z
4x3x3MM SSS



OZ-BH-2BB
5x3x3MM SSS
Finish:BM



OZ-BH-2BB
4x3x3MM SSS



OZ-BH-2BB-E
4x3x3MM SSS

Fire Rated Butt Hinges with Two Ball Bearings*



SS-304



OZ-BHF-2BB-C 4x3x3MM SSS

SS Butt Hinges with & without Ball Bearings

SS-304



OZ-BH-NBB
4x2.5x2.5MM SSS



OZ-BH-NBB
5x2.5x2.5MM SSS

Economy Series without Ball Bearings

E Series
SS-202



OZ-BH-NBB-E
3x2x1.3MM SSS



OZ-BH-NBB-E
4x2.5x2.5MM SSS



OZ-BH-NBB-E
5x2.5x2.5MM SSS

TELESCOPIC SLIDING DOOR SYSTEMS FOR WOODEN AND FRAMED DOORS



Ozone introduces the Wooden Synchronized Manual Telescopic Sliding Door System to achieve Maximum clear door opening. Door panels can be stacked on one side in-line with the top track and require minimal parking space.

Its ideal applications are in residential and commercial interior spaces as internal partitioning system. For more details, send an enquiry at support@ozone-india.com.

Specifications:

- Maximum Width of Panels: 1000mm
- Maximum Weight of Panels: 90Kg
- Maximum Thickness of Panels: 35mm
- Available Track length: 3mtr & 4mtr
- Finish: Aluminum Anodized

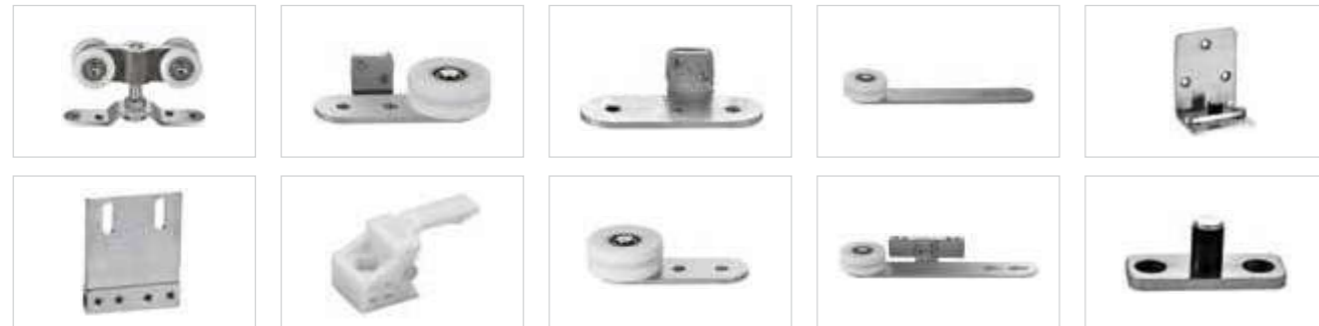

3 PANEL DOOR SLIDING SET:

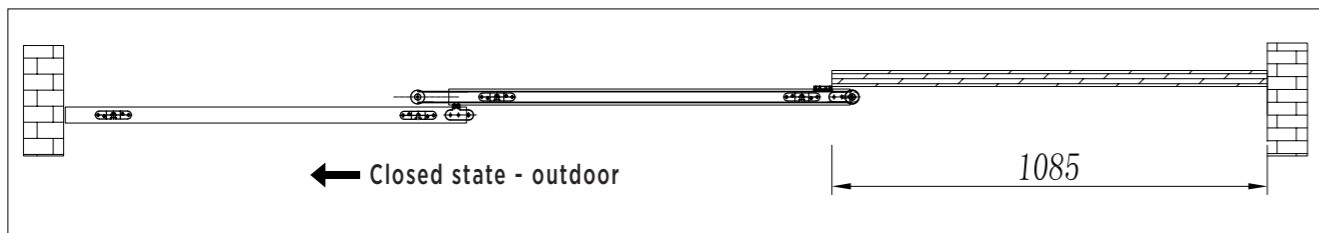

OSL-TW-03 R Std AN
Right Hand Opening

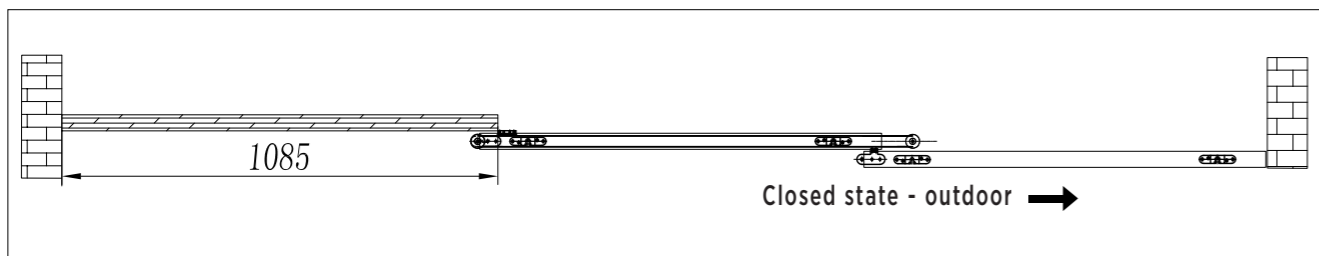

OSL-TW-03 L Std AN
Left Hand Opening

TELESCOPIC SLIDING DOOR SYSTEMS FOR WOODEN AND FRAMED DOORS

4 PANEL DOOR SLIDING SET:

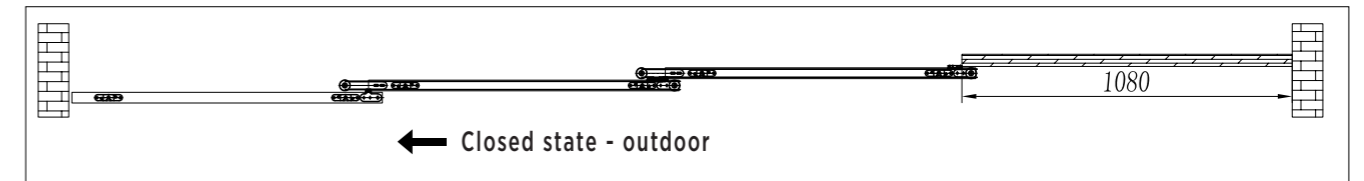

OSL-TW-04 R Std AN
Right Hand Opening

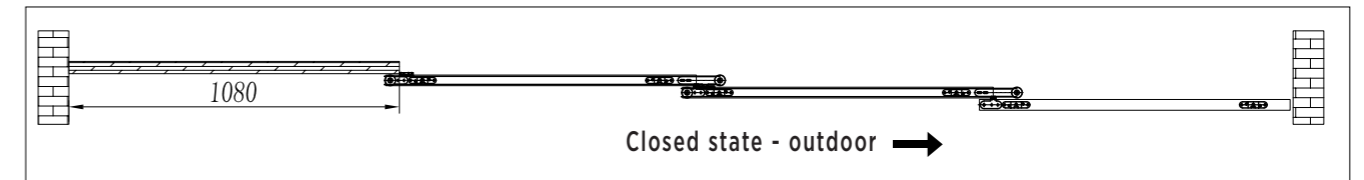

OSL-TW-04 L Std AN
Left Hand Opening

TOP TRACK & ACCESSORIES

Top Track & Accessories For 3 Panels (OSL-TG-3R/3L)

OSL-TW-Track-ACC-3mtr AN 3mtr Track with other Accessories	OSL-TW-Track-ACC-4mtr AN 4mtr Track with other Accessories
Top Track-2Pcs.	Pelmet Cover-2Pcs.
SS Rope, 2.3mtr-1Pc.	

Top Track & Accessories For 4 Panels (OSL-TG-4R/4L)

OSL-TW-Track-ACC-3mtr AN 3mtr Track with other Accessories	OSL-TW-Track-ACC-4mtr AN 4mtr Track with other Accessories
Top Track-2Pcs.	Pelmet Cover-2Pcs.
SS Rope, 2.3mtr-1Pc.	

Additional Accessories Required For 4 Panels

OSL-TGW-Track-3mtr AN for 3mtr
(Bottom U channel 1pc)

OR

OSL-TGW-Track-4mtr AN for 4mtr
(Bottom U channel 1pc)



Bottom U Channel

OSL-TGW-Rope-2mtr SS
(SS Rope 2.3 mtr 1pc)



SS Rope, 2.3mtr



SLIDING FOLDING SYSTEM - 555 FOR FRAMED/WOODEN DOORS



Ozone offers Sliding Folding Partitioning System for wood & framed door panels in different panel configurations. This system is a combination of various stainless steel fittings to enable achieving desired partitioning width and smooth sliding folding movement of the panels. Our technical team can help you to create customized options.

Features:

- SS Hinges SS-304
- Aluminium top & bottom with anodized finish
- Nylon hanger/roller

Specifications:

- Maximum opening: 8mtr
- Maximum panel weight: 80kg
- Maximum panel height: 3000mm
- Maximum panel width: 1000mm
- Min panel thickness: 35mm



Scan QR for Installation Video

FITTINGS (Images only for reference)

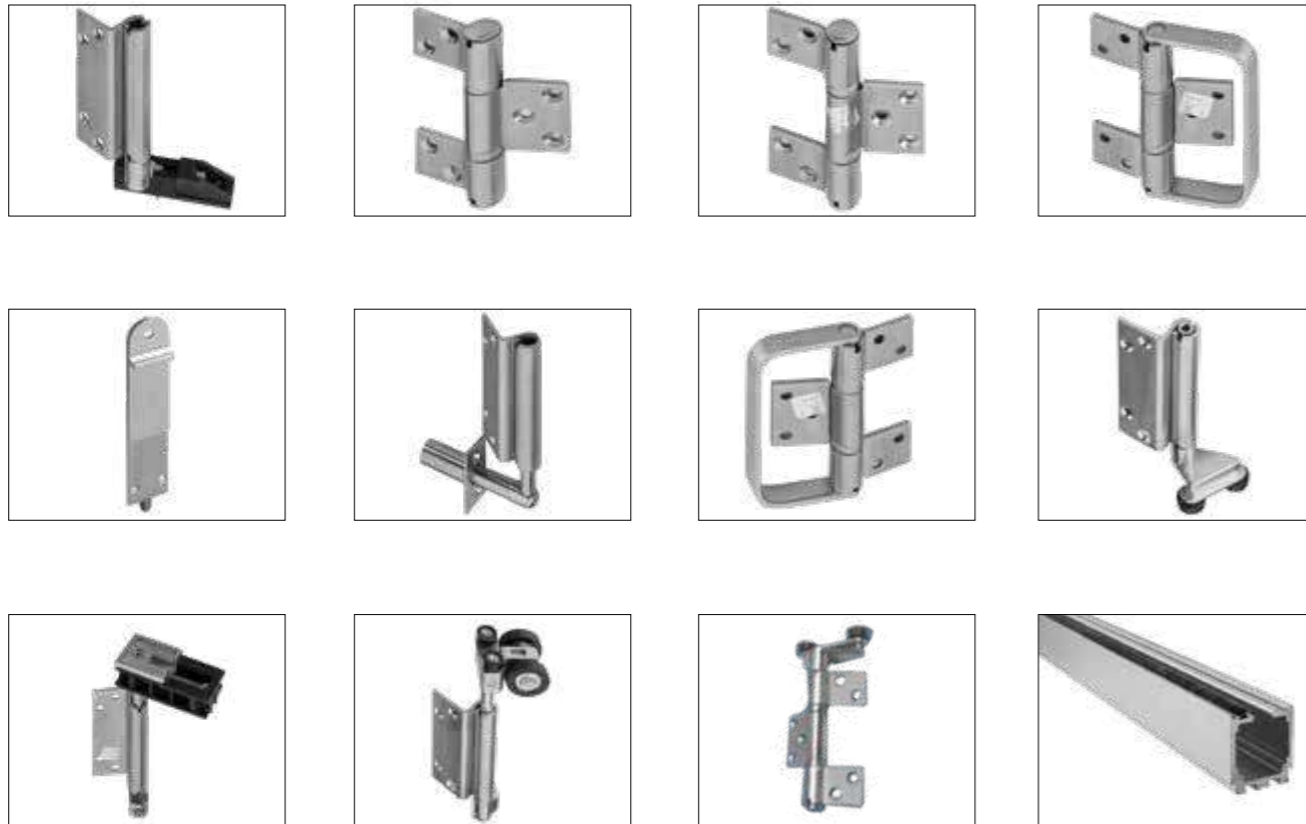

Product Kit Components:

How to Order						
	SL-WSFS-555-2 2 Panel Sliding Folding set	SL-WSFS-555-3 3 Panel Sliding Folding set	SL-WSFS-555-4 4 Panel Sliding Folding set	SL-WSFS-555-5 5 Panel Sliding Folding set	SL-WSFS-555-6 6 Panel Sliding Folding set	SL-WSFS-555-8 8 Panel Sliding Folding set
SL-WSFS-555 WOOD FOLD SYSTEM						
Pivot set (A) 	1 Set	1 Set	1 Set	1 Set	1 Set	1 Set
Offset hinge set (B) 		1 Set	2 Set	1 Set	2 Set	2 Set
Center hinge set (C) 	1 Set	-	1 Set	1 Set	1 Set	2 Set
Intermediate carrier set (D) 	-	1 Set	1 Set	2 Set	2 set	3 Set
Right/ Left carrier set (E) 	1 Set	-	1 Set	-	1 Set	1 Set
Drop bolt (F) 	1 No.	1 No.	2 Nos.	2 Nos.	3 Nos.	4 Nos.
 TOP TRACK-2M BOTTOM TRACK-2M	1 Set	-	2 Set	1 Set	-	-
 TOP TRACK-3M BOTTOM TRACK-3M	-	1 Set	-	1 Set	2 Set	-
 TOP TRACK-4M BOTTOM TRACK-4M	-	-	-	-	-	2 Set

Note:- For ordering purpose refer the table on next page.

PREMIUM MANUAL SLIDING SYSTEMS

Heavy duty 80-150kg also available



S Series
Premium Collection of
Architectural Hardware

Item Codes:

- OZSL-P-S-SYS STD SSS
- OZSL-P-S-Track 2mtr SSS

Key Features:

- Soft closing single sliding wooden door
- Suitable for office, kitchen, living room, and pocket doors
- Elegant and slim design
- Can be mounted on glass, wall, and ceiling
- Internationally patented in Germany as per EN1527 standards
- Roller tested for 100,000 cycles
- Hydraulic soft closing bumper-Tested for 2,00,000 impact cycles
- Energy efficient-prevents AC loss by allowing minimum 5mm gap between sliding & fixed glass
- Adjustable soft closing pulling force for different door weight 40-80kg

Specifications:

- Slim Track Size: 54x58mm
- Door height adjustment +/-3.5mm on carriage and prevent the de-railing of sliding door
- Maximum door weight: 40-80kg / 2 carriages
- Aluminium anodised top track
- Finish: SS or brushed clear
- Length: 2mtr (Standard) and 4mtr (Against order)



Soft Close

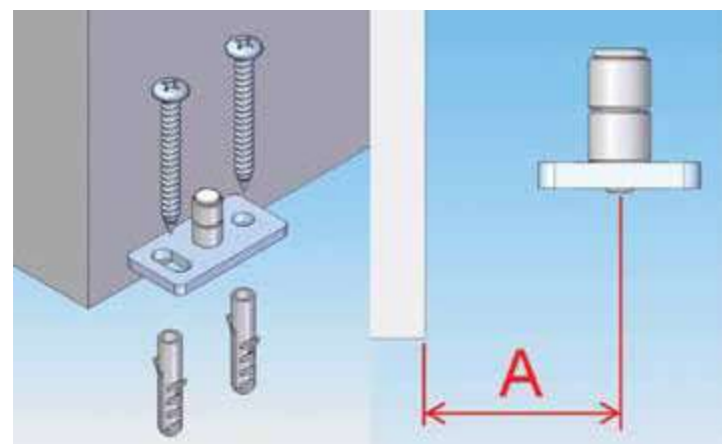

OZ-SD-754 (Floor Guide)

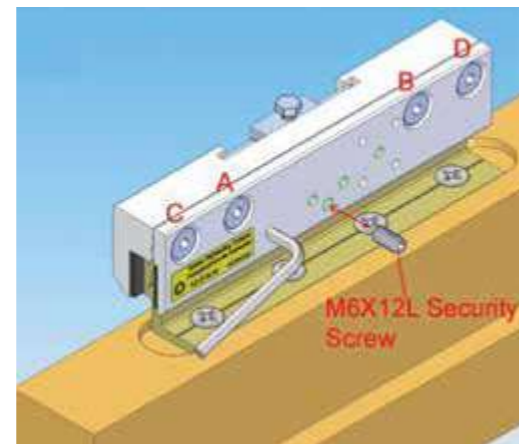

OZ-LYON-101 (Wooden Clamp)

INVISIBLE SLIDING SYSTEM



OZ-SL-INV-SYS-80 1.22 mtr Std

Features:

- Partially door opening : 650-1070mm
- Concealed rail partition door
- 80Kg loading capacity, not easy to deform
- Anti fall off sliding door system
- Doorway width : 533-935mm (door fully open)
- Removable dampener positioning
- Flexible adjustment, easy & convenient
- Elegant design, smooth & silent
- Easy installation

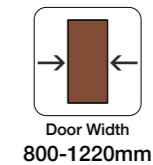

Fitting Details:

Description	Top Roller	Soft Close Damper	Side Roller	Floor Guide
Product Image				
Qty.	1	2	2	1

Description	Bottom Roller	End Cap	Top Rail	Bottom Rail
Product Image				
Qty.	2	1	1	1

*Available on request

SLIDING SYSTEM FOR WOODEN/FRAMED DOORS



OZ-ESL-WD-11-80
Sliding System Set W/O Track for Single Framed/Wooden Door of **80kg**



OZ-ESL-WD-11-100
Sliding System Set W/O Track for Single Framed/Wooden Door of **100kg**



OZ-ESL-TRACK-E2
Top Track Suitable for ESL-WD-11-80 and WD-11-100 (Available in 2mtr & 4mtr)

SOFT CLOSE SLIDING SYSTEM FOR FRAMED/WOODEN DOORS



OZ-ESL-WD-44-SC-N STD STD
Soft Close Sliding System with Accessories for Framed/Wooden Door (Single Door) W/O Track Maximum Door Weight: 60kg/Door



OZ-ESL-TRACK-E5-N 2mtr STD
OZ-ESL-TRACK-E5-N 4mtr STD
Top Track Available in 2mtr & 4mtr



OZ-ESL-FG-BT 2 mtrs STD
Bottom Track

SLIDING SYSTEM FOR WOODEN/FRAMED DOORS FOR HOTEL BATHROOMS



OZ-ESL-WD-22-140
Framed/Wooden Sliding Door System W/O Track for 140kg Door (Available with Side Wall-to-track Holder)



OZ-ESL-TRACK-E3-A1
OZ-ESL-TRACK-E3-A2
Wall-to-track Connector



OZ-ESL-TRACK-E3
Top Track Suitable for ESL-WD-22-140 Available in 2mtr & 4mtr Length

HANDLES FOR WOODEN SLIDING DOORS



SL-WD-HN-10
Sliding Door Handle for Wooden Door



OZ-ESL-WD-ACC-11 STD PSS
Lock and Handle for Wooden Sliding Door



OZ-ESL-WD-ACC-22N
Mortise Sliding Door Lock



ERGOTECH SLIM DRAWER SYSTEM

Maximizing Internal Storage Space

OE-DWDS-SL Anth Grey-Product Kit



Key Features:

- Full-extension drawer system for a smooth and consistent closure
- Slim wall (only 13 mm) provides more usable space as to drawer
- Undermount slides equipped with Dual-Synchro and slow motion (FR) damping technology provide smooth and controlled movement
- Side panel equipped with inbuilt catch for concealed slides
- Integrated front panel adjustment

Specifications:

- Slim and Sleek, Double walled drawer system
- Load capacity of 40Kg
- Available sizes: 450-550mm (18-22inch)
- System height: 89, 126 & 174 mm

Kit Includes:

- Undermount Full Ext. Slide Set, L & R Each
- Double Walled Slim Side Panel Set, L & R Each
- Front Panel Connectors Set, L & R Each
- Cover Cap With Ozone Logo, 2 Pcs



SOFT CLOSE

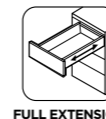

FULL EXTENSION



40 Kg
WT. CARRYING
CAPACITY



DUAL-SYNCHRO



Sizes Available in Grey Color:

OE-DWDS-SL-N 89x450MM ANTHGREY
OE-DWDS-SL-N 89x500MM ANTHGREY
OE-DWDS-SL-N 89x550MM ANTHGREY
OE-DWDS-SL-N 126x450MM ANTHGREY
OE-DWDS-SL-N 126x500MM ANTHGREY
OE-DWDS-SL-N 126x550MM ANTHGREY
OE-DWDS-SL-N 174x450MM ANTHGREY
OE-DWDS-SL-N 174x500MM ANTHGREY
OE-DWDS-SL-N 174x550MM ANTHGREY

White finish also available against bulk orders

KITCHEN, WARDROBE & FURNITURE FITTINGS

With end-to-end innovative hardware solutions, we aim to help and guide you in planning your Kitchens, Wardrobes, and Interiors. Our extensive range of fixtures and hardware is designed to optimize functionality. The range includes Ergotech Drawer Systems, Telescopic Channels, Kitchen Organizers, Lift-up Systems, Aluminium Profiles, Hinges, Roller Shutter Systems, Cabinetry Accessories, Pantry/Tall Units, Corner Units, Pull-out Tables, Motorized Tables, Wardrobe Fittings, Bed Fittings, and much more. Offering optimally designed solutions that are accustomed to the present demand to match the needs of our consumers.

SLIM ERGOTECH INNER DRAWER New



REGULAR
Component Details:
Front Rail-1100mm,
Front Bracket

Item Code	Line Drawing
OE-DWDS-SL-ID-FS STD GREY	
OE-DWDS-SL-ID-FB-109MM STD GREY	



LARGE
Component Details:
Front Bracket,
Front Rail-1100mm,
Square Cross Rail

Item Code	Line Drawing
OE-DWDS-SL-ID-FB-195MM STD GREY	
OE-DWDS-SL-ID-FS STD GREY	
OE-DWDS-SL-ID-SR-195MM STD GREY	

ERGOTECH SQUARE RAIL New



Ordering Details

Item Code	Size
OE-DWDS-SL-SQ-RL 450MM GREY	450mm
OE-DWDS-SL-SQ-RL 500MM GREY	500mm
OE-DWDS-SL-SQ-RL 550MM GREY	550mm

Note: Supplied along with back and front connector

ERGOTECH STANDARD DRAWER SYSTEM KIT

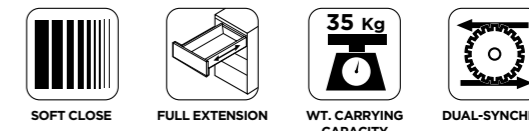

Item Code	Description
OE-DWDS MG 84x350MM	System for 350mm (14")
OE-DWDS MG 84x400MM	System for 400mm (16")
OE-DWDS MG 84x450MM	System for 450mm (18")
OE-DWDS MG 84x500MM	System for 500mm (20")
OE-DWDS MG 84x550MM	System for 550mm (22")

ERGOTECH DRAWER SYSTEM WITH SINGLE RAILS

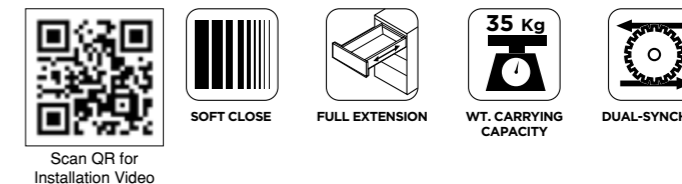

Item Code	Description
OE-DWDS-SR MG 135x350MM	System for 350mm (14")
OE-DWDS-SR MG 135x400MM	System for 400mm (16")
OE-DWDS-SR MG 135x450MM	System for 450mm (18")
OE-DWDS-SR MG 135x500MM	System for 500mm (20")
OE-DWDS-SR MG 135x550MM	System for 550mm (22")

ERGOTECH DRAWER SYSTEM WITH DOUBLE RAILS



SOFT CLOSE



FULL EXTENSION



35 Kg
WT. CARRYING CAPACITY



DUAL-SYNCHRO



Item Code	Description
OE-DWDS-DR MG 199x500MM	System for 500mm (20")
OE-DWDS-DR MG 199x550MM	System for 550mm (22")

ERGOTECH DRAWER SYSTEM WITH METAL SIDE SUPPORT WALLS



SOFT CLOSE

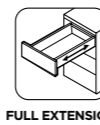

FULL EXTENSION



35 Kg
WT. CARRYING CAPACITY



DUAL-SYNCHRO



Item Code	Description
OE-DWDS-SMW MG 199x500MM	System for 500mm (20")
OE-DWDS-SMW MG 199x550MM	System for 550mm (22")

CLASSIC FIT - PVC CUTLERY ORGANIZERS



OK-CT-N 900MM MG
(Available without divider)
Size (mm) : 830 x 485 x 50 (WxDxH)



OK-CT-N 600MM MG
(Available with divider)
Size (mm) : 530 x 485 x 50 (WxDxH)



OK-CT-N 450MM MG
(Available with divider)
Size (mm) : 380 x 485 x 50 (WxDxH)

Compatible with Slim & Regular Ergotech Drawer Systems

SS CUTLERY TRAY



OK-CT-SS-01 500MM SSS
Size (mm) : 103 x 472 x 65 (WxDxH)



OK-CT-SS-02 500MM SSS
Size (mm) : 280 x 472 x 65 (WxDxH)



OK-CT-SS-03 500MM SSS
Size (mm) : 380 x 472 x 65 (WxDxH)



OK-CT-SS-04 500MM SSS
Size (mm) : 535 x 472 x 65 (WxDxH)



OK-CT-SS-05 500MM SSS
Size (mm) : 535 x 472 x 65 (WxDxH)

Key Features:

- Made of Stainless steel 304 with plastic end covers
- Convenient way of storing cutlery
- Space Saving with Elegant design
- For carcass external depth 500mm
- Various arrangements are possible in a drawer

DRAWER MAT

Compatible with Regular Ergotech Drawer Systems

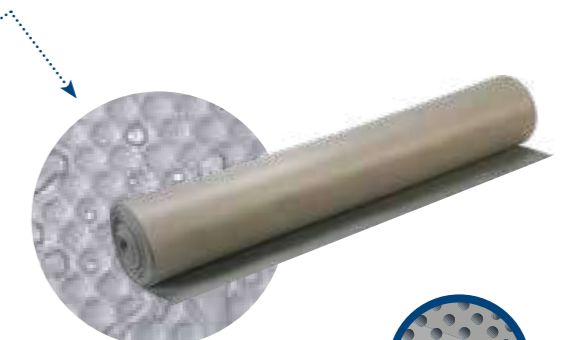

OK-ASM 0.5x4M GR
OK-ASM 0.5x2M GR

Width: 500mm
Available in 2 mtr & 4 mtr

Compatible with Slim & Regular Ergotech Drawer Systems

HORIZONTAL & VERTICAL DIVIDING PANEL



- Both horizontal and vertical dividing panels are fitted with appropriate end fittings
- Must be used in conjunction with double wall high metal drawer sides

Item Code	Description	Products
OE-DWDS-PA-HDP-G MG 1100MM	Works in conjunction with glass clip set	
OE-DWDS-PA-HDP-M MG 1100MM	Fixed with metal hanging panel (OE-DWDS-SSE-R)	
OE-DWDS-PA-VDP MG STD	Vertical divide panel	

Compatible with Regular Ergotech Drawer Systems

INTER DIVIDING GALLERY RAIL KITS



Item Code	Description	Product
OE-DWDS-PA-RL MG 1100MM	Horizontal/Transversal Rail	
OE-DWDS-PA-TC MG STD	T-Connector	
OE-DWDS-PA-CC MG STD	Connecting clip	
OE-DWDS-PA-EC MG STD	End cap	

Compatible with Regular Ergotech Drawer Systems

- Cross Railing available in 1100mm size with T or L connectors
- Quantity can be ordered as per the requirement

ADJUSTABLE DISH ORGANIZERS

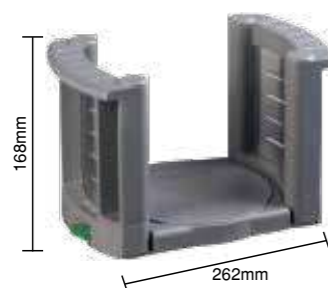

OK-APH-SS GR
Adjustable Dish Holder

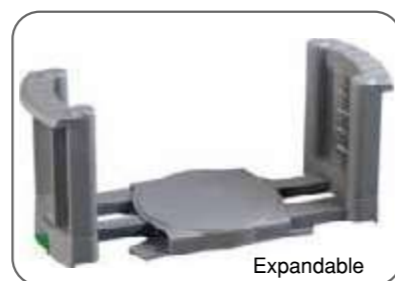

Expandable

Compatible with Slim & Regular Ergotech Drawer Systems

PANTRY UNITS WITH SQUARE RAIL

- Ergotech Pantry Unit's inner drawers can be installed at any height as per your choice
- Simply take one of our Ergotech standard 84 mm drawer set and with addition of Pantry Drawer Front Set turn your cabinet into Pantry/Ladder Unit



How to Order

Item Code	Detail	Standard Height (84mm, Length 500mm)	Medium Height (135mm, Length 500mm)	Tall Height (199mm, Length 500mm)
OE-PU-FP 1100MM MG	Front panel 1100mm	01 PC (as per length requirement)	01 PC (as per length requirement)	01 PC (as per length requirement)
OE-PU-FB 84MM MG	Front bracket 84mm	01 set	-	-
OE-DWDS-ACC-BB MG 84MM	Back bracket 84mm	01 set	-	-
OE-DWDS-W/O BB MG 500MM	Metal walls & L/R sliding channel-500mm	01 set	01 set	01 set
OE-PU-FB 135MM MG	Front bracket 135mm	-	01 set	-
OE-DWDS-ACC-BB MG 135MM	Back bracket 135mm	-	01 set	-
OE-PU-RLSQ 500MM MG	Single SQUARE rail gallery 500mm	-	01 set	01 set
OE-PU-FHSQ-1100MM MG	Square front handle 1100mm	-	01 PC (as per length requirement)	01 PC (as per length requirement)
OE-PU-FB 199MM MG	Front bracket 199mm	-	-	01 set
OE-DWDS-ACC-BB MG 199MM	Back bracket-199mm	-	-	01 set
OE-PU-RLSQ-D 500MM MG	Double SQUARE rail gallery 500mm	-	-	01 set



Standard Height Drawer



Medium Height Drawer



Large Height Drawer

PANTRY UNITS WITH ROUND RAIL

- Ergotech Pantry Unit's inner drawers can be installed at any height as per your choice
- Simply take one of our Ergotech standard 84 mm drawer set and with addition of Pantry Drawer Front Set turn your cabinet into Pantry/Ladder Unit

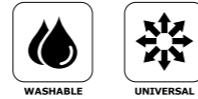

How to Order

Item Code	Detail	Standard Height (84mm, Length 500mm)	Medium Height (135mm, Length 500mm)	Tall Height (199mm, Length 500mm)
OE-PU-FP 1100MM MG	Front panel 1100mm	01 PC (as per length requirement)	01 PC (as per length requirement)	01 PC (as per length requirement)
OE-PU-FB 84MM MG	Front bracket 84mm	01 set	-	-
OE-DWDS-ACC-BB MG 84MM	Back bracket 84mm	01 set	-	-
OE-DWDS-W/O BB MG 500MM	Metal walls & L/R sliding channel-500mm	01 set	01 set	01 set
OE-PU-FB 135MM MG	Front bracket 135mm	-	01 set	-
OE-DWDS-ACC-BB MG 135MM	Back bracket 135mm	-	01 set	-
OE-DWDS-RL MG-500MM	Single ROUND rail gallery 500mm	-	01 set	01 set
OE-PU-FHSQ-1100MM MG	Square front handle 1100mm	-	01 PC (as per length requirement)	01 PC (as per length requirement)
OE-PU-FB 199MM MG	Front bracket 199mm	-	-	01 set
OE-DWDS-ACC-BB MG 199MM	Back bracket-199mm	-	-	01 set
OE-DWDS-RL-D MG 500MM	Double ROUND rail gallery 500mm	-	-	01 set



UNDERMOUNT SOFT CLOSE SLIDES FOR WIRE BASKET

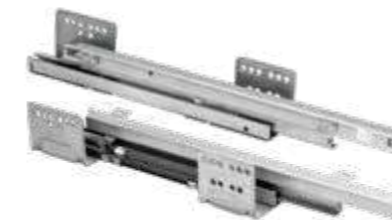

- Soft Close
- Full Extension
- Weight Carrying Capacity: 35kg
- Finish Available: Zinc



Accessories



Item Code	Description
OE-UMS-SC-FE-11 450MM-18" ZINC	18" Full Extension Soft Close Drawer Slide
OE-UMS-SC-FE-11 500MM-20" ZINC	20" Full Extension Soft Close Drawer Slide

UNDERMOUNT SOFT CLOSE SLIDES



- Soft Close
- Full Extension
- Weight Carrying Capacity: 35kg
- Finish Available: Zinc
- 48 Hours Salt Spray Tested



Scan QR for Installation Video

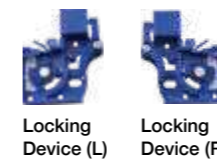

Item Code	Description
OE-UMS-SC-FE-D 300MM-12" ZINC	12" Full Extension Soft Close Drawer Slide
OE-UMS-SC-FE-D 350MM-14" ZINC	14" Full Extension Soft Close Drawer Slide
OE-UMS-SC-FE-D 400MM-16" ZINC	16" Full Extension Soft Close Drawer Slide
OE-UMS-SC-FE-D 450MM-18" ZINC	18" Full Extension Soft Close Drawer Slide
OE-UMS-SC-FE-D 500MM-20" ZINC	20" Full Extension Soft Close Drawer Slide
OE-UMS-SC-FE-D 550MM-22" ZINC	22" Full Extension Soft Close Drawer Slide
OE-UMS-SC-FE-D 600MM-24" ZINC	24" Full Extension Soft Close Drawer Slide

UNDERMOUNT PUSH OPEN SLIDES



- Push Open
- Partial Extension Slide
- Weight Carrying Capacity: 25kg

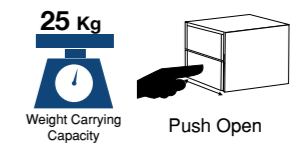

OZ-CR-SE-PO Locking Pin

Item Code	Description
OZ-CR-SE-PO 300MM-12" ZINC	12" Partial Extension Slide
OZ-CR-SE-PO 350MM-14" ZINC	14" Partial Extension Slide
OZ-CR-SE-PO 400MM-16" ZINC	16" Partial Extension Slide
OZ-CR-SE-PO 450MM-18" ZINC	18" Partial Extension Slide
OZ-CR-SE-PO 500MM-20" ZINC	20" Partial Extension Slide
OZ-CR-SE-PO 550MM-22" ZINC	22" Partial Extension Slide
OZ-CR-SE-PO 600MM-24" ZINC	24" Partial Extension Slide

SOFT CLOSE BALL BEARING SLIDES New



- Soft Close
- Full Extension
- Weight Carrying Capacity: 45kg
- Finish Available: Zinc
- 48 Hours Salt Spray Tested



Item Code	Description
OBBS-4511SC 300MM-12" ZINC	12" Full Extension Soft Close Drawer Slide
OBBS-4511SC 350MM-14" ZINC	14" Full Extension Soft Close Drawer Slide
OBBS-4511SC 400MM-16" ZINC	16" Full Extension Soft Close Drawer Slide
OBBS-4511SC 450MM-18" ZINC	18" Full Extension Soft Close Drawer Slide
OBBS-4511SC 500MM-20" ZINC	20" Full Extension Soft Close Drawer Slide
OBBS-4511SC 550MM-22" ZINC	22" Full Extension Soft Close Drawer Slide
OBBS-4511SC 600MM-24" ZINC	24" Full Extension Soft Close Drawer Slide

PUSH OPEN BALL BEARING SLIDES



- Push Open
- Full Extension
- Weight Carrying Capacity: 35kg
- Finish Available: Zinc
- 24 Hours Salt Spray Tested

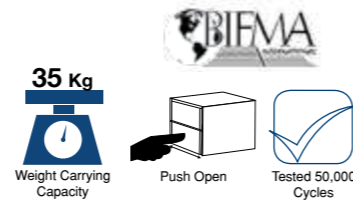

Item Code	Description
OBBS-4511PO 300MM 12" ZINC	12" Full Extension Drawer Slide
OBBS-4511PO 350MM 14" ZINC	14" Full Extension Drawer Slide
OBBS-4511PO 400MM 16" ZINC	16" Full Extension Drawer Slide
OBBS-4511PO 450MM 18" ZINC	18" Full Extension Drawer Slide
OBBS-4511PO 500MM-20" ZINC	20" Full Extension Drawer Slide
OBBS-4511PO 550MM 22" ZINC	22" Full Extension Drawer Slide
OBBS-4511PO 600MM 24" ZINC	24" Full Extension Drawer Slide

SS 304 FULL EXTENSION BALL BEARING SLIDES



S Series
Premium Collection of Architectural Hardware

- Full Extension
- Weight Carrying Capacity: 45kg
- Finish Available: Stainless Steel
- 300 Hours Salt Spray Tested

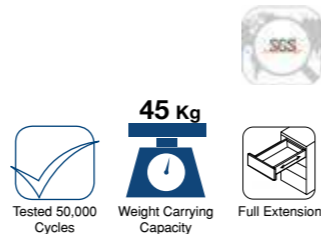

Item Code	Description
OBBS-4511-304S 350MM-14" SS	14" Full Extension Ball Bearing Slide
OBBS-4511-304S 400MM-16" SS	16" Full Extension Ball Bearing Slide
OBBS-4511-304S 450MM-18" SS	18" Full Extension Ball Bearing Slide
OBBS-4511-304S 500MM-20" SS	20" Full Extension Ball Bearing Slide
OBBS-4511-304S 550MM-22" SS	22" Full Extension Ball Bearing Slide

STANDARD BALL BEARING SLIDES



Black finish available on request

- Full Extension
- Weight Carrying Capacity: 45kg
- Finishes Available: Zinc & Black
- 48 Hours Salt Spray Tested



Item Code	Description
OBBS-4511 200MM-8" ZINC	8" Ball Bearing Drawer Slide
OBBS-4511 250MM-10" ZINC	10" Ball Bearing Drawer Slide
OBBS-4511 300MM-12" ZINC	12" Ball Bearing Drawer Slide
OBBS-4511 350MM-14" ZINC	14" Ball Bearing Drawer Slide
OBBS-4511 400MM-16" ZINC	16" Ball Bearing Drawer Slide
OBBS-4511 450MM-18" ZINC	18" Ball Bearing Drawer Slide
OBBS-4511 500MM-20" ZINC	20" Ball Bearing Drawer Slide
OBBS-4511 550MM-22" ZINC	22" Ball Bearing Drawer Slide
OBBS-4511 600MM-24" ZINC	24" Ball Bearing Drawer Slide
OBBS-4511 650MM-26" ZINC	26" Ball Bearing Drawer Slide
OBBS-4511 700MM-28" ZINC	28" Ball Bearing Drawer Slide
OBBS-4511 750MM-30" ZINC	30" Ball Bearing Drawer Slide
OBBS-4511 900MM-36" ZINC	36" Ball Bearing Drawer Slide

E-SERIES BALL BEARING SLIDES



Black finish available on request

- Full Extension
- Weight Carrying Capacity: 35kg
- Finishes Available: Zinc & Black
- 24 Hours Salt Spray Tested

E Series

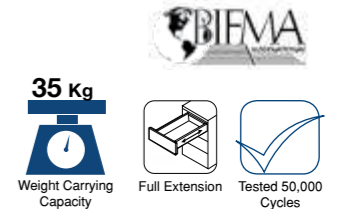

Item Code	Description
OBBS-4511-E35 200MM-8" ZINC	8" Full Extension Drawer Slide
OBBS-4511-E35 250MM-10" ZINC	10" Full Extension Drawer Slide
OBBS-4511-E35 300MM-12" ZINC	12" Full Extension Drawer Slide
OBBS-4511-E35 350MM-14" ZINC	14" Full Extension Drawer Slide
OBBS-4511-E35 400MM-16" ZINC	16" Full Extension Drawer Slide
OBBS-4511-E35 450MM-18" ZINC	18" Full Extension Drawer Slide
OBBS-4511-E35 500MM-20" ZINC	20" Full Extension Drawer Slide
OBBS-4511-E35 550MM-22" ZINC	22" Full Extension Drawer Slide
OBBS-4511-E35 600MM-24" ZINC	24" Full Extension Drawer Slide

HEAVY DUTY BALL BEARING SLIDES



- Full Extension
- Weight Carrying Capacity: 100kg
- Finish Available: Zinc



Item Code	Description
OBBS-FE-100HD 750MM-30" ZINC	30" Full Extension Heavy Duty Ball Bearing Slides
OBBS-FE-100HD 900MM-36" ZINC	36" Full Extension Heavy Duty Ball Bearing Slides

AIR HINGE 

- Opening Angle: 105
- Door Thickness: 18-32mm
- Finish: Titanium Black
- 3D Adjustment



OZ-WB-AH-3D 25KG T-BLACK



Air Hinge Connector



OZ-WB-AH-ACC

SOFT CLOSE CLIP-ON 3D ADJ. HINGE WITH LINEAR MOUNTING PLATE & COVER CAP 

- Opening Angle: 105
- Door Thickness: 14-22mm
- 3D Adjustment
- Finish: Titanium Black
- 50,000 Cycle Tested
- 24 hrs Salt Spray Tested



OEC451LN-A2S-SC 3D T-BLACK
OEC451LN-B2S-SC 3D T-BLACK
OEC451LN-C2S-SC 3D T-BLACK

SOFT CLOSE CLIP-ON 3D ADJ. HINGE WITH 3 HOLE MOUNTING PLATE 

- Opening Angle: 100
- Door Thickness: 14-20mm
- 3D Adjustment
- Finish: Nickel Plated
- 50,000 Cycle Tested
- 48 hrs Salt Spray Tested



OEC451-A3S-SC 3DA NP
OEC451-B3S-SC 3DA NP
OEC451-C3S-SC 3DA NP

SOFT CLOSE CLIP-ON 3D ADJ. HINGE WITH 2 HOLE MOUNTING PLATE

- Opening Angle: 100
- Door Thickness: 14-24mm
- 3D Adjustment
- Finish: Nickel Plated
- 40,000 Cycle Tested
- 48 hrs Salt Spray Tested



OEC451-A2S-SC 3DA NP
* OEC451-A2S-SCN 3DA NP



OEC451-B2S-SC 3DA NP
* OEC451-B2S-SCN 3DA NP



OEC451-C2S-SC 3DA NP
* OEC451-C2S-SCN 3DA NP

* Note: Above codes are not inclusive of Cover Caps & Screws

SOFT CLOSE CLIP-ON HINGE WITH 4 HOLE MOUNTING PLATE & COVER CAP

- Opening Angle: 105
- Door Thickness: 14-22mm
- Soft Close Clip-on
- Finish: Nickel Plated
- 50,000 Cycle Tested
- 48 hrs Salt Spray Tested



OEC451-A4S-SC C0 NP
* OEC451-A4S-SCN C0 NP



OEC451-B4S-SC C8 NP
* OEC451-B4S-SCN C8 NP



OEC451-C4S-SC C15 NP
* OEC451-C4S-SCN C15 NP

* Note: Above codes are not inclusive of cover caps & screws

SOFT CLOSE CLIP-ON HINGE WITH 2 HOLE MOUNTING PLATE & COVER CAP

- Opening Angle: 95°
- Door Thickness: 14-24mm
- Soft Close Clip-on
- Finish: Nickel Plated
- 40,000 Cycle Tested
- 48 hrs Salt Spray Tested



OEC451-A2S-SC C0 NP
* OEC451-A2S-SCN C0 NP



OEC451-B2S-SC C8 NP
* OEC451-B2S-SCN C8 NP



OEC451-C2S-SC C15 NP
* OEC451-C2S-SCN C15 NP

* Note: Above codes are not inclusive of cover caps & screws

SOFT CLOSE CLIP-ON THICK DOOR HINGE WITH 2 HOLE MOUNTING PLATE

- Opening Angle: 95
- Door Thickness: 16-30mm
- Thick Door Hinge
- Finish: Nickel Plated
- 50,000 Cycle Tested
- 24 hrs Salt Spray Tested



OEC501-A2S-SC C0 NP



OEC501-B2S-SC C8 NP



OEC501-C2S-SC C15 NP

SOFT CLOSE SCREW-ON HINGE WITH 4 HOLE MOUNTING PLATE

- Opening Angle: 105
- Door Thickness: 14-22mm
- Soft Close Screw-on
- Finish: Nickel Plated
- 50,000 Cycle Tested
- 48 hrs Salt Spray Tested



OEC451-SO-A4S-SC C0 NP



OEC451-SO-B4S-SC C8 NP



OEC451-SO-C4S-SC C15 NP

SOFT CLOSE SCREW-ON HINGE WITH 2 HOLE MOUNTING PLATE

- Opening Angle: 105
- Door Thickness: 14-22mm

- Soft Close Screw-on
- Finish: Nickel Plated

- 50,000 Cycle Tested
- 48 hrs Salt Spray Tested



OEC451-SO-A2S-SC C0 NP



OEC451-SO-B2S-SC C8 NP



OEC451-SO-C2S-SC C15 NP

AUTO CLOSE CLIP-ON HINGE WITH 2 HOLE MOUNTING PLATE

- Opening Angle: 110
- Door Thickness: 14-24mm

- Auto Close Clip-on
- Finish: Nickel Plated

- 50,000 Cycle Tested
- 24 hrs Salt Spray Tested



OEC476-A2S C0 NP



OEC476-B2S C8 NP



OEC476-C2S C15 NP

E-SERIES AUTO CLOSE CLIP-ON HINGE WITH 2 HOLE MOUNTING PLATE

- Opening Angle: 110
- Door Thickness: 14-22mm

- E-Series Auto Close Clip-on
- Finish: Nickel Plated

- 50,000 Cycle Tested
- 48 hrs Salt Spray Tested



EC351-CO-A2S-C0 NP



EC351-CO-B2S-C8 NP



EC351-CO-C2S-C15 NP

AUTO CLOSE SCREW-ON HINGE WITH 4 HOLE MOUNTING PLATE & COVER CAP

- Opening Angle: 110
- Door Thickness: 14-22mm

- Auto Close Screw-on
- Finish: Nickel Plated

- 50,000 Cycle Tested
- 48 hrs Salt Spray Tested



EC351-A4S C0 NP



EC351-B2S C8 NP



EC351-C4S C15 NP

E-SERIES AUTO CLOSE SCREW-ON HINGE WITH 4 HOLE MOUNTING PLATE

- Opening Angle: 110°
- Door Thickness: 14-22mm

- Auto Close Screw-on
- Finish: Nickel Plated

- 50,000 Cycle Tested
- 48 hrs Salt Spray Tested



EC351-SO-A4S C0 NP



EC351-SO-B4S C8 NP



EC351-SO-C4S C15 NP

AUTO CLOSE SCREW-ON HINGE WITH 2 HOLE MOUNTING PLATE & COVER CAP

- Opening Angle: 110
- Door Thickness: 14-22mm

- Auto Close Screw-on
- Finish: Nickel Plated

- 40,000 Cycle Tested
- 48 hrs Salt Spray Tested



EC351-A2S C0 NP



EC351-B2S C8 NP



EC351-C2S C15 NP

AUTO CLOSE SCREW-ON THICK DOOR HINGE WITH 2 HOLE MOUNTING PLATE

- Opening Angle: 95
- Door Thickness: 20-28mm

- Thick Door Hinge
- Finish: Nickel Plated

- 50,000 Cycle Tested
- 48 hrs Salt Spray Tested



EC401-A2S C0 NP



EC401-B2S C8 NP



EC401-C2S C15 NP

E-SERIES AUTO CLOSE SCREW-ON HINGE WITH 2 HOLE MOUNTING PLATE

- Opening Angle: 110
- Door Thickness: 14-22mm

- E-Series Auto Close Screw-on
- Finish: Nickel Plated

- 50,000 Cycle Tested
- 48 hrs Salt Spray Tested



EC351-SO-A2S C0 NP



EC351-SO-B2S C8 NP



EC351-SO-C2S C15 NP

SOFT CLOSE CLIP-ON WIDE ANGLE HINGE WITH 2 HOLE MOUNTING PLATE

- Opening Angle: 165°
- Door Thickness: 14-24mm
- Wide Angle Hinge
- Finish: Nickel Plated
- 50,000 Cycle Tested
- 48 hrs Salt Spray Tested



OEC170-SC-A2S C0 NP



OEC170-SC-B2S C8 NP



OEC170-SC-C2S C15 NP

AUTO CLOSE SCREW-ON WIDE ANGLE HINGE WITH 2 HOLE MOUNTING PLATE

- Opening Angle: 165
- Door Thickness: 14-24mm
- Wide Angle Hinge
- Finish: Nickel Plated
- 50,000 Cycle Tested
- 48 hrs Salt Spray Tested



OEC352-A2S C0 NP



OEC352-B2S C8 NP



OEC352-C2S C15 NP

SOFT CLOSE SCREW-ON BLIND CORNER HINGE WITH 2 HOLE MOUNTING PLATE & COVER CAP

- Opening Angle: 90
- Door Thickness: 14-24mm
- Blind Corner Hinge
- Finish: Nickel Plated
- 50,000 Cycle Tested
- 24 hrs Salt Spray Tested



OEC451-G2S-SC STD NP

AUTO CLOSE SCREW-ON BLIND CORNER HINGE WITH 2 HOLE MOUNTING PLATE

- Opening Angle: 100
- Door Thickness: 14-24mm
- Blind Corner Hinge
- Finish: Nickel Plated
- 40,000 Cycle Tested
- 48 hrs Salt Spray Tested



OEC35-G2S STD NP

AUTO CLOSE CLIP-ON 19MM AL. PROFILE HINGE WITH 2 HOLE MOUNTING PLATE & COVER CAP

- Opening Angle: 95
- Al. Profile Size: 19-25mm
- 19mm Al. Profile Hinge
- Finish: Nickel Plated
- 50,000 Cycle Tested
- 24 hrs Salt Spray Tested



OEC430-A2S-AL C0 NP



OEC430-B2S-AL C8 NP



OEC430-C2S-AL C15 NP

AUTO CLOSE SCREW-ON 30°/ 45° FACE ANGLE HINGE WITH 2 HOLE MOUNTING PLATE & COVER CAP

- Opening Angle: 95
- Door Thickness: 14-22mm
- Special Face Angle Hinge
- Finish: Nickel Plated
- 40,000 Cycle Tested
- 24 hrs Salt Spray Tested



30° Face Angle

OEC35-F2S STD NP



45° Face Angle

OEC35-E2S STD NP

AUTO CLOSE SCREW-ON PIE CORNER HINGE WITH 2 HOLE MOUNTING PLATE

- Opening Angle: 135
- Door Thickness: 14-24mm
- Pie Corner Hinge
- Finish: Nickel Plated
- 50,000 Cycle Tested
- 48 hrs Salt Spray Tested



OEC35-H2S STD NP

AUTO CLOSE SCREW-ON SHORT ARM HINGE WITH 4 HOLE MOUNTING PLATE



- Opening Angle: 95
- Door Thickness: 15-18mm
- Short Arm Hinge
- Finish: Nickel Plated
- 50,000 Cycle Tested
- 24 hrs Salt Spray Tested



EC351-SA-A4S C0 NP

BOTTLE PULL-OUT



Code	Available Sizes
OK-BPO-02-L-150MM CP	150mm
OK-BPO-02-R-150MM CP	150mm

Note: Supplied along with slides

MULTI-PURPOSE PULL-OUT



Code	Available Sizes
OK-BPO-02-L-200MM CP	200mm
OK-BPO-02-R-200MM CP	200mm
OK-BPO-02-L-300MM CP	300mm
OK-BPO-02-R-300MM CP	300mm

Note: Supplied along with slides

KITCHEN TALL UNIT- PANTRY PULL-OUT



- Silent Mechanism
- Adjustable frame height
- Available in 2 different width
 - 450mm
 - 600mm
- Available in 2 different adjustable height
 - 1150-1410mm
 - 1900-2160mm

Available Sizes:

Item Code	Size
OK-TU-F-02-8B-450MM SS OK-TU-B-02-8B-450MM SS	450mm(W) (4+4) Basket & Frames
OK-TU-F-8B-600MM SS OK-TU-B-8B-600MM SS	600mm(W) (4+4) Basket & Frames
OK-TU-F-02-12B-450MM SS OK-TU-B-02-12B-450MM SS	450mm(W) (6+6) Basket & Frames
OK-TU-F-02-12B-600MM SS OK-TU-B-02-12B-600MM SS	600mm(W) (6+6) Basket & Frames



Scan QR for Installation Video

WICKER BASKETS



Item Code	Size
OZ-EK-WB 450x100 BEIGE	414 x 508 x 100
OZ-EK-WB 450x150 BEIGE	414 x 508 x 150
OZ-EK-WB 450x200 BEIGE	414 x 508 x 200
OZ-EK-WB 600x100 BEIGE	564 x 508 x 100
OZ-EK-WB 600x150 BEIGE	564 x 508 x 150
OZ-EK-WB 600x200 BEIGE	564 x 508 x 200

Note: Supplied along with wooden slides

CORNER ORGANIZERS

S Carousel



Scan QR for Installation Video

Code	Available Sizes
OK-SC-02-R-900MM CP	900mm Right Mechansim
OK-SC-02-L-900MM CP	900mm Left Mechansim

Magic Corner

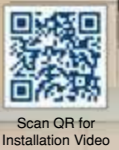

Scan QR for Installation Video

Code	Available Sizes
OK-MCB-900MM SSS	900mm Basket
OK-MCF-L-900MM SSS	900mm Left Frame
OK-MCF-R-900MM SSS	900mm Right Frame

ROLLER SHUTTER SYSTEMS



Roller Shutter Mechanism (PVC, Aluminium) (Silver Finish)

Product Code
OE-RS-M 600x1400 AN
Size(WxH)
600x1400



SS DISH RACK WITH DRAIN TRAY



Code	Available Sizes
OK-DR-N 600MM SSS	600mm
OK-DR-N 800MM SSS	800mm
OK-DR-N 900MM SSS	900mm

EXTENDED TABLE-3 TYPES New



OE-PUTE-1L STD SSS
Width Panel Size: 600-1200mm
Internal Minimum Drawer Size:
Height-170mm Depth-460mm



OE-PUTE-2 STD SSS
Width Panel Size: 600-1200mm
Internal Minimum Drawer Size:
Height-146mm Depth-550mm



OE-PUTE-3 STD SSS
Width Panel Size: 600-1200mm
Internal Minimum Drawer Size:
Height-135mm Depth-540mm

KITCHEN TRASH BINS



OK-POB-2 STD GREY
• Pull Out Trash Compartment bins have 6 type of Adjustments Left, Right, Up, Down, Forward and Backward.
• It is Base mounted Bin.
Size (mm): 303 x 360 x 224 (WxDxH)
10L x 2 with door mount bracket
• Max Weight Carrying Capacity: 25kg



OZ-POB-3 STD GREY
• Pull Out Trash Bin
20L + 10L x 2 with door mount bracket
20L Size (mm): 303 x 360 x 224 (WxDxH)
10L Size (mm): 224 x 360 x 151 (WxDxH)
• Max Weight Carrying Capacity: 25kg



OK-RB 14 LTR SS
• Swing Out Trash Bin
Size (mm): 365 x 280 x 355 (WxDxH)
• Max Weight Carrying Capacity: 14ltr

ALUMINIUM SKIRTING



Square/Flexi Corner Connector

OK-SK-100 3MTRS SSS
OK-SK-150 3MTRS SSS

PVC Skirting with Aluminium Foil
Length: 3mtr
Finish: SSS



Flexible Connector

OK-SK-ACC 100MM SSS
OK-SK-ACC 150MM SSS

Flexible Connectors with bottom plastic seal
Height: 100mm & 150mm
Finish: SSS

CABINET LEGS WITH CLIPS



OK-ALC 150MM BL
Adjustable Leg with Clip
Set= 4Legs+2Clips



OK-ALC 100MM BL
Adjustable Leg with Clip
Set= 4Legs+2Clips



OK-ALC-ACC-RC
Adjustable Legs Clip
500Pcs in one Pkt.

HEAVY DUTY BI-FOLD LIFT UP SYSTEM - SOFT CLOSE New

OK-LU-BF-HD STD GREY
Ideal for higher wall cabinets

Carcas Details:

Width	Height	Max. Weight (Per Lift-Up Shutter)
600-1200mm	600-800mm	9.4Kg

Set comprises:

- Lift-up Mechanism with Cover: 01 pair
- Auto Close Hinges: 01 pair
- Center Hinges with Accessories

Power Adjustable



Note: Supplied with cabinet and center connecting hinges

90° OPENING HEAVY-DUTY LIFT-UP SYSTEM - 3D ADJUSTABLE SOFT CLOSE New

Order no.	Max. Weight(kg)	Cabinet Width	Cabinet Height
OK-LU-90HD STD GR	13.25	900-1800 mm	600-700 mm
OK-LU-90N STD GR	6	600-1200 mm	500-600 mm
OK-LU-90N STD WHITE	6	600-1200 mm	500-600 mm



(Cabinet Hinges are not required)



Scan QR for Installation Video



Available in White Colour also against bulk order

PNEUMATIC GAS PUMPS



Product Code
OK-PP-01SPRO 60N GR
OK-PP-01SPRO 80N GR
OK-PP-01SPRO 100N GR
OK-PP-01SPRO 120N GR

PNEUMATIC GAS PUMPS SOFTPRO (With Cover on Arms)



Product Code
OK-PP-01N 60N GR
OK-PP-01N 80N GR
OK-PP-01N 100N GR
OK-PP-01N 120N GR

PNEUMATIC GAS PUMPS

ALUMINIUM FRAME PROFILES FOR GLASS PANELS/SHUTTERS



Image	Profile Type	Finish	Code
	45 mm Alu. Frame profile	Aluminium Anodized	OEAP-45F 3M AN
		Black Matt	OEAP-45F 3M BM
		Satin Stainless Steel	OEAP-45F 3M SS
		Champagne	OEAP-45F 3M CH
		Rose Gold Glossy	OEAP-45F 3M RGG
	45 mm H Alu. Handle profile	Aluminium Anodized	OEAP-45H 3M AN
		Black Matt	OEAP-45H 3M BM
		Satin Stainless Steel	OEAP-45H 3M SS
		Champagne	OEAP-45H 3M CH
		Rose Gold Glossy	OEAP-45H 3M RGG
	45 mm H2 Alu. Handle profile	Aluminium Anodized	OEAP-45H2 3M AN
		Black Matt	OEAP-45H2 3M BM
		Satin Stainless Steel	OEAP-45H2 3M SS
		Champagne	OEAP-45H2 3M CH
		Rose Gold Glossy	OEAP-45H2 3M RGG
	50mm Alu. Frame profile	Aluminium Anodized	OEAP-50F 3M AN
		Black Matt	OEAP-50F 3M BM
		Satin Stainless Steel	OEAP-50F 3M SS
		Champagne	OEAP-50F 3M CH
		Rose Gold Glossy	OEAP-50F 3M RGG
	50mm H Alu. Handle profile	Aluminium Anodized	OEAP-50H 3M AN
		Black Matt	OEAP-50H 3M BM
		Satin Stainless Steel	OEAP-50H 3M SS
		Champagne	OEAP-50H 3M CH
		Rose Gold Glossy	OEAP-50H 3M RGG

ALUMINIUM FRAME PROFILES FOR WOODEN PANELS/SHUTTERS



Image	Profile Type	Finish	Code
	G Handle profile (Groove-in)	Aluminium Anodized	OEAP-G 3M AN
		Black Matt	OEAP-G 3M BM
		Satin Stainless Steel	OEAP-G 3M SS
		Champagne	OEAP-G 3M CH
		Rose Gold Glossy	OEAP-G 3M RGG
	G2 Handle profile (Groove-in)	Aluminium Anodized	OEAP-G2 3M AN
		Black Matt	OEAP-G2 3M BM
		Satin Stainless Steel	OEAP-G2 3M SS
		Champagne	OEAP-G2 3M CH
		Rose Gold Glossy	OEAP-G2 3M RGG
	J Handle profile (Groove-in)	Aluminium Anodized	OEAP-J 3M AN
		Black Matt	OEAP-J 3M BM
		Satin Stainless Steel	OEAP-J 3M SS
		Champagne	OEAP-J 3M CH
		Rose Gold Glossy	OEAP-J 3M RGG

ALUMINIUM FRAME PROFILES FOR GLASS PANELS/SHUTTERS



	BV-Handle profile (Groove-in)	Aluminium Anodized	OEAP-BV 3M AN
		Black Matt	OEAP-BV 3M BM
		Satin Stainless Steel	OEAP-BV 3M SS
		Champagne	OEAP-BV 3M CH
		Rose Gold Glossy	OEAP-BV 3M RGG
	SV-Handle profile (Groove-in)	Aluminium Anodized	OEAP-SV 3M AN
		Black Matt	OEAP-SV 3M BM
		Satin Stainless Steel	OEAP-SV 3M SS
		Champagne	OEAP-SV 3M CH
		Rose Gold Glossy	OEAP-SV 3M RGG
	F-Handle profile (Groove-in)	Aluminium Anodized	OEAP-F1-3M AN
		Black Matt	OEAP-F1-3M BM
		Satin Stainless Steel	OEAP-F1-3M SS
		Champagne	OEAP-F1-3M CH
		Rose Gold Glossy	OEAP-F1-3M RGG

KITCHEN GOLA PROFILE



Image	Profile Type	Finish	Code
	J Gola Profile	Aluminium Anodized	OEAP-JG 3M AN
		Black Matt	OEAP-JG 3M BM
		Satin Stainless Steel	OEAP-JG 3M SS
		Champagne	OEAP-JG 3M CH
		Rose Gold Glossy	OEAP-JG 3M RGG
	C Gola Profile	Aluminium Anodized	OEAP-CG 3M AN
		Black Matt	OEAP-CG 3M BM
		Satin Stainless Steel	OEAP-CG 3M SS
		Champagne	OEAP-CG 3M CH
		Rose Gold Glossy	OEAP-CG 3M RGG
	Verical J Gola	Aluminium Anodized	OEAP-VJG 3M AN
		Black Matt	OEAP-VJG 3M BM
		Satin Stainless Steel	OEAP-VJG 3M SS
		Champagne	OEAP-VJG 3M CH
		Rose Gold Glossy	OEAP-VJG 3M RGG
	Verical C Gola	Aluminium Anodized	OEAP-VCG 3M AN
		Black Matt	OEAP-VCG 3M BM
		Satin Stainless Steel	OEAP-VCG 3M SS
		Champagne	OEAP-VCG 3M CH
		Rose Gold Glossy	OEAP-VCG 3M RGG
	Wall Gola	Aluminium Anodized	OEAP-WG 3M AN
		Black Matt	OEAP-WG 3M BM
		Satin Stainless Steel	OEAP-WG 3M SS
		Champagne	OEAP-WG 3M CH
		Rose Gold Glossy	OEAP-WG 3M RGG

KITCHEN GOLA PROFILES New

	Light Gola	Aluminium Anodized	OEAP-LG 3M AN
		Black Matt	OEAP-LG 3M BM
		Satin Stainless Steel	OEAP-LG 3M SS
		Champagne	OEAP-LG 3M CH
		Rose Gold Glossy	OEAP-LG 3M RGG
	Sink Profile	Aluminium Anodized	OEAP-SINK 3M AN

END CAPS New

Image	Item	Finish	Code
	End cap set for G2 handle profile	Aluminium Anodized	OEAP-ACC-EC-G2 AN
	Set=L+R	Black Matt	OEAP-ACC-EC-G2 BM
	End cap set for J gola profile	Aluminium Anodized	OEAP-ACC-EC-JG AN
	Set=L+R	Black Matt	OEAP-ACC-EC-JG BM
	End cap set for C gola profile	Aluminium Anodized	OEAP-ACC-EC-CG AN
	Set=L+R	Black Matt	OEAP-ACC-EC-CG BM
	End cap set for Sink profile	Grey	OEAP-ACC-SINK-EC GREY
	Set=L+R		

CONNECTORS New

Image	Item	Finish	Code
	E90 connector for 45mm Glass Profile (Set=4x Connector + 16x Screws)	Zinc Plated	OEAP-ACC1 STD
	Special 90 connector for 50 mm Glass Profile (Set=4x Connector + 8x Screws)	Zinc Plated	OEAP-ACC2 STD
	L Cabinet Connector for J & C Gola Profiles (Set=4x Connector + 16x Screws)	Zinc Plated	OEAP-ACC3 STD

AVAILABLE FINISH



UNI-LINE WARDROBE SLIDING SYSTEM New



OE-WS-UNL-80 2.4MTR STD
OE-WS-UNL-80 3MTR STD

Features:

- High-end 2 door Wardrobe Sliding System
- Two shutters closes in the same line leaving NO gap
- Soft open and soft close
- Suitable to use on wooden as well as aluminum framed glass doors

Specifications:

- Can be used on doors weighing upto 80kg each
- Suitable for Wardrobe width 2200mm - 3000mm



Scan QR for Installation Video

80 Kg



Weight Carrying Capacity

Accessories	Qty.	3D Sketch
Upper Rail	1	
Down Rail	1	
Upper Runner Middle Regulator	2	
Upper Runner side Regulator	2	
Down runner middle Regulator	2	
Down runner side Regulator	2	
15-8 Spanner	1	
Side Spring	2	

*Check product details before placing order.

TOP GLIDE SYSTEM - 22 FOR TRIPLE DOORS WARDROBES



Specifications:

- Door Type: Wooden/Framed
- Application Type: 3 Doors
- Door Installation: Overlay
- Track Length: 3mtr

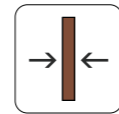

Door Thickness
18-28mm



Weight Carrying
Capacity

TOP GLIDE SYSTEM - 22 W (for Triple Wooden Doors)

Product Code	OE-WS-TG22W-TR-3D STD STD Top Roller Set	OE-WS-TG1A/22-BR-3D STD STD Bottom Roller Set	OE-WS-TG22-TT 3MTR AN Top Track 3mtr length	OE-WS-TG1A/22-BT 3MTR AN Bottom Track 3mtr length	OE-WS-TG22-SC STD GR Common Soft Close Dampner for wooden and framed doors
Product Image					
Set Qty.	1 Set	1 Set	1 Pc. (Length)	1 Pc. (Length)	1 Set

TOP GLIDE SYSTEM - 22 F (for Triple Framed Doors)

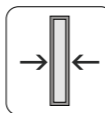

Door Thickness
18-22mm



Weight Carrying
Capacity

Product Code	OE-WS-TG22F-TR-3D STD STD Top Roller Set	OE-WS-TG1A/22-BR-3D STD STD Bottom Roller Set	OE-WS-TG22-TT 3MTR AN Top Track 3mtr length	OE-WS-TG1A/22-BT 3MTR AN Bottom Track 3mtr length
Product Image				
Set Qty.	1 Set	1 Set	1 Pc. (Length)	1 Pc. (Length)

TOP GLIDE SYSTEM 22 FOR DOUBLE DOORS WARDROBE



Specifications:

- Utilizes full inner space in the wardrobe
- Tracks not visible
- Door Installation: Overlay
- Can be used for wardrobe width upto 10 feet
- Track mounting: Top
- Application type: Double Door



Scan QR for
Installation Video

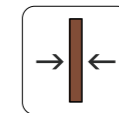

Door Thickness
18-28mm



Weight Carrying
Capacity

TOP GLIDE SYSTEM - 22 W (for Wooden Doors)

Product Code	OE-WS-TG22W-TR STD STD Top Roller Set	OE-WS-TG1A/22-BR STD STD Bottom Roller Set	OE-WS-TG22-TT 3MTR AN Top Track 3mtr length	OE-WS-TG1A/22-BT 3MTR AN Bottom Track 3mtr length	OE-WS-TG22-SC STD GR Common Soft Close Dampner for wooden and framed doors
Product Image					
Set Qty.	1 Set	1 Set	1 Pc. (Length)	1 Pc. (Length)	1 Set

TOP GLIDE SYSTEM - 22 F (for Framed Doors)

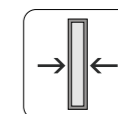

Door Thickness
18-22mm



Weight Carrying
Capacity

Product Code	OE-WS-TG22F-TR STD STD Top Roller Set	OE-WS-TG1A/22-BR STD STD Bottom Roller Set	OE-WS-TG22-TT 3MTR AN Top Track 3mtr length	OE-WS-TG1A/22-BT 3MTR AN Bottom Track 3mtr length
Product Image				
Set Qty.	1 Set	1 Set	1 Pc. (Length)	1 Pc. (Length)

TOP GLIDE SYSTEM - 1 FOR DOUBLE DOOR WARDROBES



- Specifications:**
- Utilizes full inner space in the wardrobe
 - Tracks not visible
 - Door Installation: Inset
 - Track mounting: Top
 - Application type: Double Door

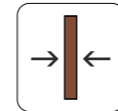

Door Thickness
18-24mm



50 Kg
Weight Carrying Capacity

INSET SLIDING SYSTEM - 1A (for Wooden Doors)

Product Code	OE-WS-TG1A-TR STD STD Top Roller Set	OE-WS-TG1A/22-BR STD STD Bottom Roller Set	OE-WS-TG1A-TT 3MTR AN Top Track 3mtr length	OE-WS-TG1A/22-BT 3MTR AN Bottom Track 3mtr length
Product Image				
Set Qty.	1 Set	1 Set	1 Pc. (Length)	1 Pc. (Length)

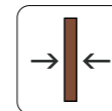

Door Thickness
20-32mm

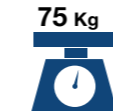

75 Kg
Weight Carrying Capacity

INSET SLIDING SYSTEM - 1B (for Wooden Doors)

Product Code	OE-WS-TG1B-TR STD STD Top Roller Set	OE-WS-TG1B-BR STD STD Bottom Roller Set	OE-WS-TG1B-TT 3MTR AN Top Track - 3mtr length	OE-WS-TG1B-BT 3MTR AN Bottom Track 3mtr length
Product Image				
Set Qty.	1 Set	1 Set	1 Pc. (Length)	1 Pc. (Length)

OZO LINE 65 BOTTOM GLIDE INSET WARDROBE SLIDING SYSTEM



- FEATURES:**
- Overlapping dual door system
 - Suitable to use with single track as well as double track
 - Superior spring mechanism for roller's better grip with track
 - Smooth functioning and long life
 - Soft closing and opening function (optional)

- SPECIFICATIONS:**
- Door type: Wooden
 - Application type: Dual door
 - Door Weight: upto **65Kg.**
 - Door Thickness: **18-25mm**



Door Thickness
18-25mm



65 Kg
Weight Carrying Capacity



Fitting Details:

PRODUCT IMAGE	PRODUCT CODES
	OE-SL65-TBR STD STD Top Roller- 04 Bottom Roller- 04 Stopper- 04 (2 Door Kits)

Tracks:

	OE-SL65-TBT 2 MTR AN OE-SL65-TBT 2.4MTR AN OE-SL65-TBT 3 MTR AN OE-SL65-TBT 3.6MTR AN Top & Bottom Double Track- 01 set
	OE-SL65-S-TBT 2.4MTR AN OE-SL65-S-TBT 3.6MTR AN Top & Bottom Single Track- 01 set

Optional Fitting:

	OE-SL65-SCD Soft Close Dampener- 01 set
--	--

ECONOMY WARDROBE SLIDING SYSTEM



- Features:**
- Economy wardrobe sliding system
 - Common flush track for top & bottom
 - Tracks length are available in 2 mtr & 4 mtr

- Applications:**
- Best suitable for
 - Overhead cabinets
 - Office cabinet
 - Small wardrobes

- Specifications:**
- Weight Carrying Capacity: **40Kg**
 - 50,000 life cycle tested
 - Door Thickness : **18-30mm**

- Fitting Set for 1 door consists
- Top Rollers: 1 Set
 - Bottom Rollers: 1 Set
 - Stopper: 1 Set



40 Kg
Weight Carrying Capacity



50,000
Cycles Tested

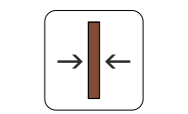

Door Thickness
18-30mm

OE-WS-BG1-E STD STD Top & Bottom Roller Set for Single Door	OE-WS-BG1-E-TRACK 2MTR AN OE-WS-BG1-E-TRACK 4MTR AN Top & Bottom Track

BOTTOM GLIDE SYSTEM



OE-WS-BG1-S STD STD

Top & Bottom Roller Set for Single Door

Features:

- Inset sliding shutters
- Bottom dom track
- Top & bottom rollers provide smooth sliding

Specifications:

- Door type: Wood
- Application type: Dual door
- Door Weight: upto 60 kg
- Door Thickness : 18-23mm
- Track mounting: Bottom
- Track length: 2/3/4 mtr for double & single leaf doors

System consists fittings for Single Door

- Top Roller: 1 Set
- Bottom Roller: 1 Set
- Stopper: 2 Pcs

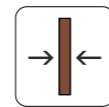

Door Thickness
18-23mm



60 Kg
Weight Carrying
Capacity

SOFT OPENING & CLOSING BOTTOM GLIDE SYSTEM New

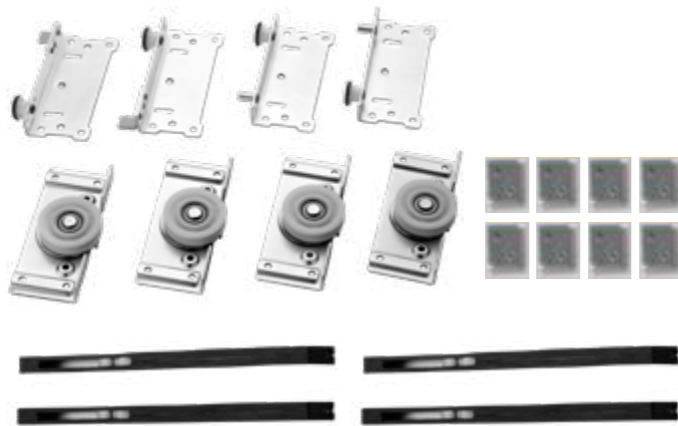

OE-WS-BG1-D-SC STD STD

Top & Bottom Roller Set for Double Door

Features:

- 2 door overlap wardrobe sliding system with both side soft close mechanism
- Ideal for door weight upto **60kg**

Specifications:

- 50,000 life cycle tested
- Suitable for door thickness upto 18-23mm with double track & any thickness with single track

Fitting Set for 2 doors consists

- Top Roller: 2 sets
- Bottom Roller: 2 sets
- Soft Close & Soft Open Dampner: 4 pcs
- Door Thickness: **18-23mm**

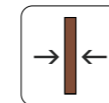

Door Thickness
18-23mm



60 Kg
Weight Carrying
Capacity



50,000
Cycles Tested

SOFT CLOSE BOTTOM GLIDE SYSTEM



OE-WS-BG1-D-SCO STD STD

Top & Bottom Roller Set for Double Door

Features:

- 2 door overlap wardrobe sliding system with both side soft close mechanism
- Ideal for door weight upto **60kg**

Specifications:

- 50,000 life cycle tested
- Suitable for door thickness upto 18-23mm with double track & any thickness with single track

Fitting Set for 2 doors consists

- Top Roller: 2 Sets
- Bottom Roller: 2 Sets
- Soft Close Dampner: 2 Pcs
- Stopper: 2Pcs
- Door Thickness: **18-23mm**

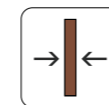

Door Thickness
18-23mm



60 Kg
Weight Carrying
Capacity



50,000
Cycles Tested

TRACKS OPTIONS FOR BOTTOM GLIDE SYSTEMS

Product Code	Track Options	Drawing
OE-WS-BG1-TT 2 MTR AN OE-WS-BG1-TT 3MTR AN OE-WS-BG1-TT 4 MTR AN Top Track (separate cover for every length)		
OE-WS-BG1-BT 2 MTR AN OE-WS-BG1-BT 3MTR AN OE-WS-BG1-BT 4 MTR AN Bottom Track (separate cover for every length)		
OE-WS-BG1-S-TT 2MTR AN OE-WS-BG1-S-TT 3MTR AN OE-WS-BG1-S-TT 4MTR AN Top Track		
OE-WS-BG1-S-BT 2MTR AN OE-WS-BG1-S-BT 3MTR AN OE-WS-BG1-S-BT 4MTR AN Bottom Track		

SWIVEL SHOE RACK



OZ-WBA-SSR 6LYR GREY
Size: 700x360x1070-1270 (6 layers)
OZ-WBA-SSR 10LYR GREY
Size: 700x360x1630-1830 (10 layers)



PULL-OUT SHOE RACK



OZ-WBA-PSR 600MM GREY
OZ-WBA-PSR 900MM GREY

SUPPLIED WITH UNDER MOUNT
SOFT CLOSE RUNNER & RUNNER
COVER



PULL-OUT TROUSER RACK



OZ-WBA-TR 600MM GREY
OZ-WBA-TR 900MM GREY

SUPPLIED WITH UNDER MOUNT
SOFT CLOSE RUNNER & RUNNER
COVER



PULL-OUT HANGER-DOUBLE



OZ-WBA-DTR GREY
Size: 630X455X115



EQUIPPED WITH SOFT CLOSE
RUNNER



PULL-OUT HANGER-SINGLE



OZ-WBA-STR GREY
Size: 340X455X114



EQUIPPED WITH SOFT CLOSE
RUNNER



HANGER LID



OZ-WBA-01 HL GREY
Size: 830-1150MM
WCC-upto 15Kg



WITH INTEGRATED SOFT CLOSE MECHANISM



RATTAN BASKET



OZ-WBA-RB 600MM GREY
OZ-WBA-RB 900MM GREY



SUPPLIED WITH UNDER MOUNT
SOFT CLOSE RUNNER & RUNNER
COVER



ASSORTMENT DRAWER



OZ-WBA-AB 600MM GREY
OZ-WBA-AB 900MM GREY



SUPPLIED WITH UNDER MOUNT
SOFT CLOSE RUNNER & RUNNER
COVER



RECTANGULAR TUBE & WALL BRACKET



OZ-WBA-RR 3MTR MG
Rectangular Rail
Cross Section: 30x12 MM
Finish: Metallic Grey



OZ-WB-ACC-BR MG
Wall Bracket
12.7x24x40.5MM
Finish: Metallic Grey

VERTICAL FOLDABLE WALL MOUNT BED - WITH AUTOMATIC MECHANISM



OZ-WBV-A-SF-1220 STD

Features:

- Concealed wall bed design
- Vertical foldable wall mount system
- Motorized mechanism with remote option
- Easy to open/close
- Adds style, comfort & flexibility

Dimension:
1200mm*2000mm (W*L)

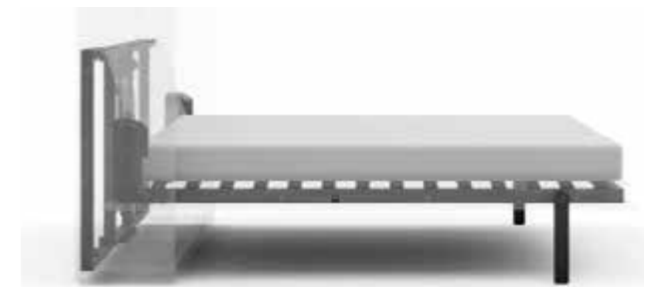

**Mattress is not included*

VERTICAL FOLDABLE WALL MOUNT BED - WITH AUTOMATIC MECHANISM



OZ-WBV-A-TB-1220 STD

Features:

- Concealed wall bed design
- Vertical foldable wall mount system
- Motorized mechanism with remote option
- Table available in vertical and horizontal options
- Adds style, comfort & flexibility

Dimension:
1200mm*2000mm (W*L)

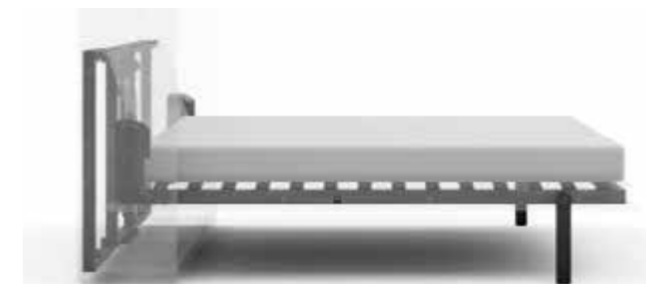

**Mattress is not included*

SMART BED LIFT-UP SYSTEM



Load Capacity



Wide Opening Angle



Easy to Lift

PRO SERIES New

Features:

- New improved design for better stability in operation
- Simple and effortless opening mechanism
- Wide opening angle enables complete & easy access to bed interior
- Convenient screw-on installation

Specifications:

- Frames sizes (L): 900mm, 1200mm, 1500mm
- Load bearing arm thickness: 6mm
- Top frame thickness: 3.5mm
- Pump loading capacity: 500N, 750N, 1000N, 1200N & 1500N
- Pump Size (CTC): 343mm
- Finish: Grey (Frame); Black (Pump)

Frame Image	Length	Product Code
	900MM	OE-BLU-FN 900MM STD GREY
	1200MM	OE-BLU-FN 1200MM STD GREY
	1500MM	OE-BLU-FN 1500MM STD GREY

Pump Image	Load Capacity	Product Code
	50kg	OE-BLU-PN 500N BLACK
	75kg	OE-BLU-PN 750N BLACK
	100kg	OE-BLU-PN 1000N BLACK
	120kg	OE-BLU-PN 1200N BLACK
	150kg	OE-BLU-PN 1500N BLACK

STANDARD SERIES

Features:

- Design for heavy duty applications operation
- Simple and effortless opening mechanism
- Wide opening angle enables complete & easy access to bed interior
- Convenient screw-on installation

Specifications:

- Frames sizes (L): 900mm, 1200mm, 1500mm & 1500 mm HD
- Load bearing arm thickness: 6mm
- Top frame thickness: 3mm & 4 mm for HD
- Pump loading capacity: 500N, 750N, 1000N, 1200N, 1500N, 1750N HD & 2000N HD
- Pump Size (CTC): 528mm
- Finish: Black (Frame); Black (Pump)

Frame Image	Length	Product Code
	900MM	OE-BLU-F 900MM STD BLACK
	1200MM	OE-BLU-F 1200MM STD BLACK
	1500MM	OE-BLU-F 1500MM STD BLACK
	1500MM HD	OE-BLU-F 1500MM HD STD BLACK

Pump Image	Load Capacity	Product Code
	50 kg	OE-BLU-P 500N BLACK
	75 kg	OE-BLU-P 750N BLACK
	100 kg	OE-BLU-P 1000N BLACK
	120 kg	OE-BLU-P 1200N BLACK
	150 kg	OE-BLU-P 1500N BLACK
	175 kg HD	OE-BLU-P 1750N HD BLACK
	200 kg HD	OE-BLU-P 2000N HD BLACK

OZO FIXES

Cams New



OZ-MF-01-L 15/18MM STD
Board Thickness 18 mm with Cover Flange
Unit: Pkt. 500 Pcs.

OZ-MF-01-L-H 15/18MM STD
Board Thickness 18 mm
Unit: Pkt. 500 Pcs.

Twister Bolt New



OZ-MF-02EU 34MM STD
Twister Bolt with Euro Thread & Black Plastic
Unit: Pkt. 500 Pcs.

OZ-MF-02 24MM STD
OZ-MF-02 34MM STD
Twister Bolt with M6 Thread & Black Plastic
Unit: Pkt. 500 Pcs.

Socket New



OZ-MF-03-E 8MM
WHITE (Expandable) Nylon Socket
Unit: Pkt. 500 Pcs.

OZ-MF-03 10MM
OFF WHITE (Non-Expandable) Nylon Socket
Unit: Pkt. 500 Pcs.

OZ-MF-03-E 10MM
WHITE (Expandable) Nylon Socket
Unit: Pkt. 500 Pcs.

Cover Cap



OZ-MF-ACC-01N STD BROWN
Plastic Cap for 15mm Cam
Unit: Pkt. 500 Pcs.

Wooden Dowels



OZ-WD-SL 6x35 STD
Wooden Dowel Pin
Unit: Pkt. 500 Pcs.



OZ-WD-SL 8x40 STD
Pkt. Wooden Dowel Pin
Unit: Pkt. 500 Pcs.

SHELF - SUPPORT New



OZ-SHL-G01
Glass Shelves
Unit: 1 Pkt. 500 Pcs.



OZ-SHL-G02
Glass Shelves
Unit: 1 Pkt. 500 Pcs.



OZ-SHL-G03
Glass Shelves
Unit: 1 Pkt. 250 Pcs.



OZ-SHL-G04
Glass Shelves
Unit: 1 Pkt. 250 Pcs.



OZ-SHL-W05
Wooden Shelves
Unit: 1 Pkt. 500 Pcs.



OZ-SHL-W06
Wooden Shelves
Unit: 1 Pkt. 500 Pcs.



OZ-SHL-W07
Wooden Shelves
Unit: 1 Pkt. 500 Pcs.

OTHER CONNECTING FITTINGS

Insert Nut New



OZ-STI-M6x10MM STD
OZ-STI-M6x12MM STD
OZ-STI-M6x15MM STD
OZ-STI-M6x18MM STD
OZ-STI-M6x20MM STD
Insert Nut & Leveller
Unit: Pkt. 500 Pcs.

Plinth Screw New



OZ-PS-M6x10MM STD
OZ-PS-M6x24MM STD
OZ-PS-M6x40MM STD
Insert Nut & Leveller
Unit: Pkt. 500 Pcs.

Push Catcher



OZ-PMC STD
STD WHITE
Push Catcher

Magnetic Catcher



OZ-MC STD STD
Magnetic Door Catcher

Butterfly



OE-CF-B
Butterfly type Connection Fitting
Unit: Pkt. 50 Sets

PASSWORD LOCK

OZFL-88 P BLACK

Password Lock
for Wooden Cabinets, Wardrobes, & Drawers
Door Thickness: 12-25mm



Master
Password



User
Password

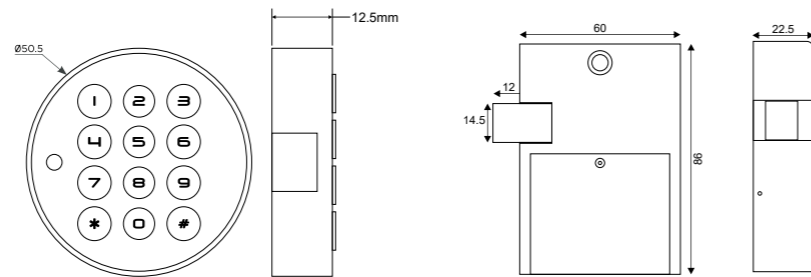

FINGERPRINT LOCK

OZFL-55 F BLACK

Fingerprint Lock
for Wooden Cabinets, Wardrobes & Drawers
Door Thickness: 12-25mm



Fingerprint

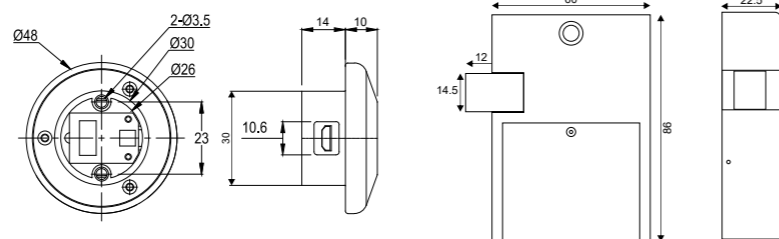

FINGERPRINT LOCK

OZFL-55 F AB

Fingerprint Lock
for Wooden Cabinets, Wardrobes, & Drawers
Door Thickness: 12-25mm



Fingerprint

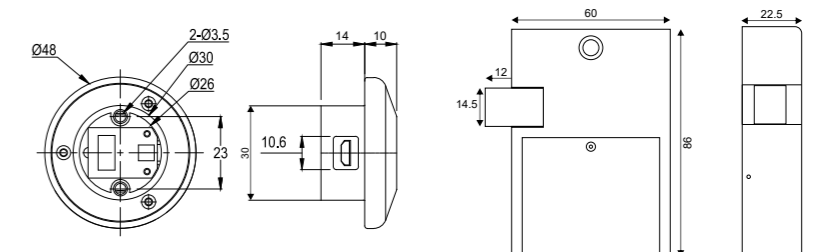

FINGERPRINT LOCK

OZFL-55 F SN

Fingerprint Lock
for Wooden Cabinets, Wardrobes, & Drawers
Door Thickness: 12-25mm



Fingerprint

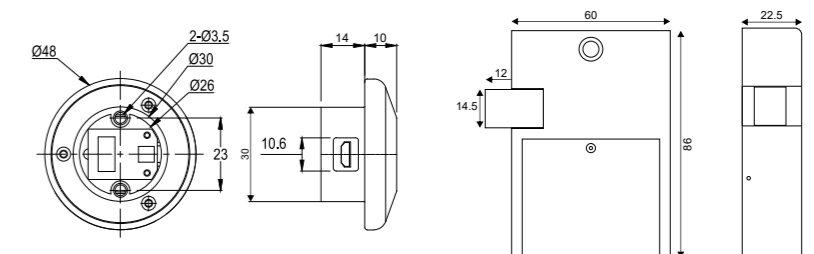

PASSWORD & KEY LOCK

OZFL-101-PK

Password & Key Lock
For Wooden / Metal Cabinets & Wardrobes
Door Thickness: 1-18mm



Master Password



Emergency Key



User Password

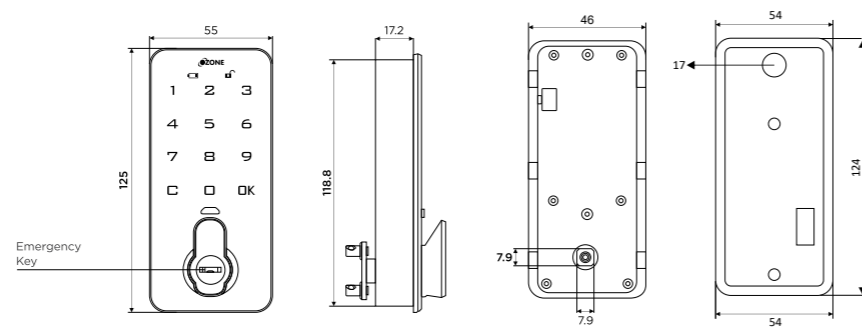

FINGERPRINT, PASSWORD, & KEY LOCK

OZFL-102-FPK

Fingerprint, Password, & Key Lock
For Wooden / Metal Cabinets & Wardrobes
Door Thickness: 1-18mm



Fingerprint



Emergency Key



Master Password



User Password

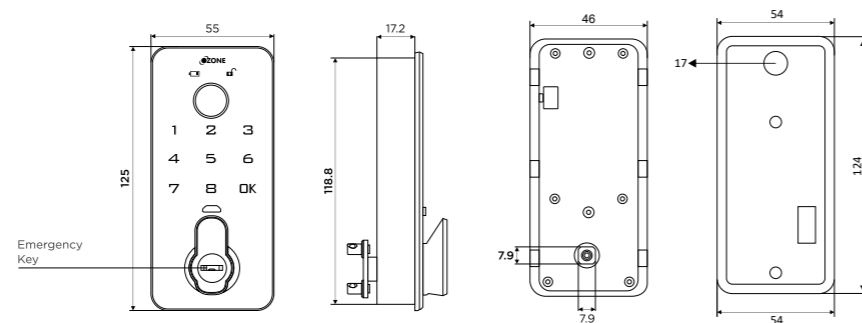

PASSWORD LOCK

* **OZFL-201-PW**

OZFL-201-LIFE PW



Password Lock
For Wooden / Metal Cabinets & Wardrobes
Door Thickness: 1-25mm



Master Password



Guest Password



User Password



OzoLife App

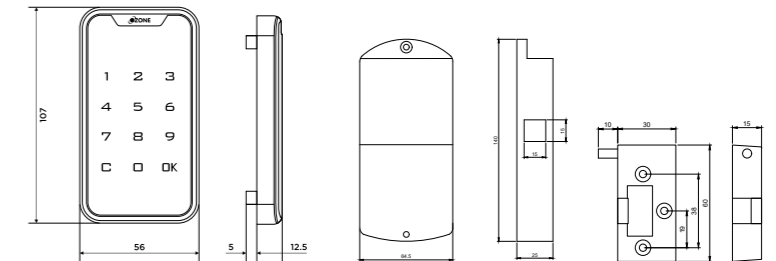

*Please Note: This product variant doesn't support OzoLife App.

RFID CARD LOCK

OZFL-202-RF

RFID Card Lock
For Wooden / Metal Cabinets & Wardrobes
Door Thickness: 1-25mm



RFID Card

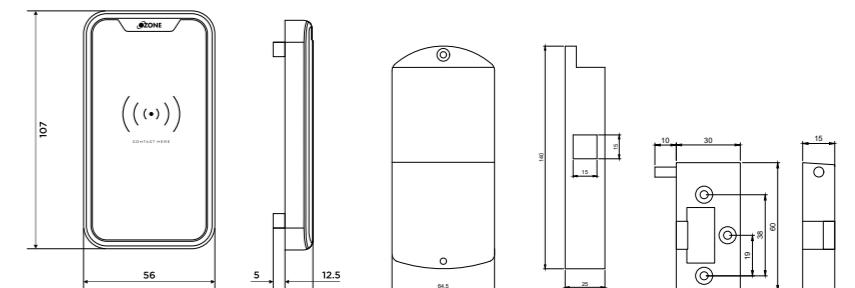

PASSWORD LOCK

OZFL-401-PW

Password Lock
for Single or Multiple Metal / Wooden Drawers
for Swing & Sliding Metal & Wooden
Cabinets & Wardrobes
Door Thickness: 1-25mm



Master Password



User Password

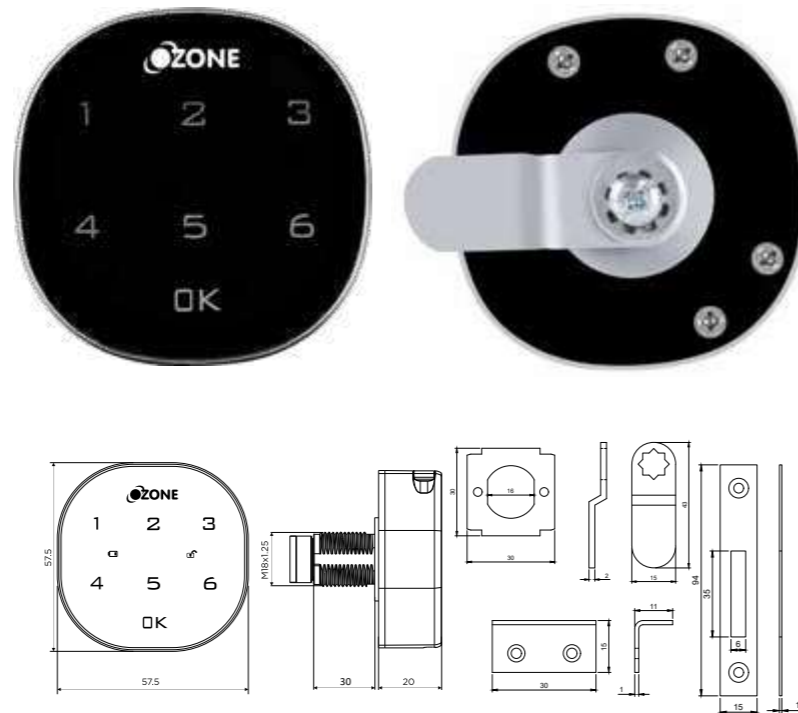

RFID LOCK

OZFL-403-RF

RFID Lock
for Single or Multiple Metal / Wooden Drawers
for Swing & Sliding Metal & Wooden,
Cabinets & Wardrobes
Door Thickness: 1-25mm



RFID Card



FINGERPRINT LOCK

OZFL-402-F

Fingerprint Lock
for Single or Multiple Metal / Wooden Drawers
for Swing & Sliding Metal & Wooden
Cabinets & Wardrobes
Door Thickness: 1-25mm



Fingerprint

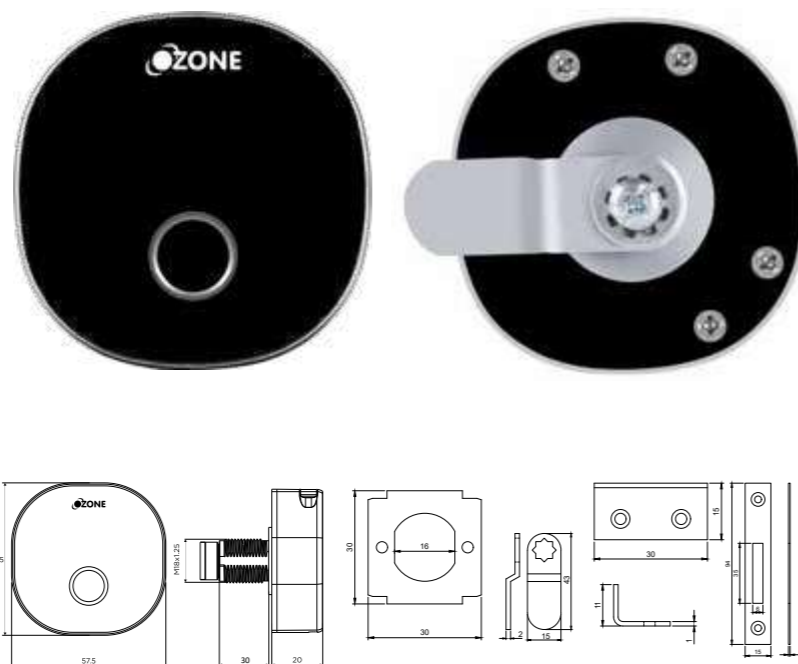

PASSWORD & FINGERPRINT LOCK

OZFL-501-PF

Password & Fingerprint Lock
for Metal Cabinet & Wardrobes
Door Thickness: 1-5mm



Master Password



Fingerprint



User Password



PASSWORD LOCK

OZFL-502-PW

Password Lock
for Metal Cabinet & Wardrobes
Door Thickness: 1-5mm



Master Password



User Password

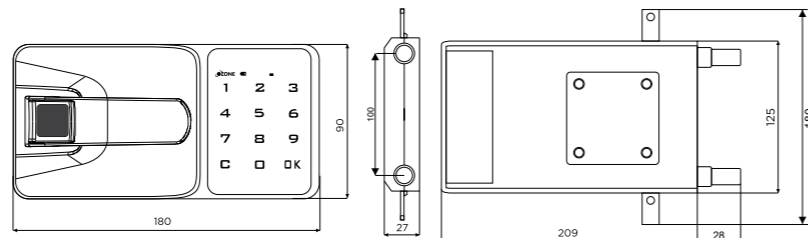

WARDROBE SLIDING DOOR LOCKS



OE-WSL1-25 STD NP
Twist & Turn Lock

Features:

- Suitable for 25mm shutters
- Twist and turn system
- Single locking for 2 overlapped sliding shutters
- Universal lock for sliding shutters with either side opening
- High security two computerized keys
- System 32 compatible



OE-WSL2-22 STD CP
Push & Turn Lock



OE-WSL2-32 STD CP
Push & Turn Lock

CUPBOARD LOCKS WITH COMPUTERIZED KEYS



OE-CL-11 20/25MM SSS
OE-CL-11 32MM SSS
Cupboard Lock



OE-CL-22 21MM SSS
Cupboard Lock (Small)



OE-CL-3P 22 2MTR CP
OE-CL-3P-22 3MTR CP
OE-CL-3P-32 2MTR CP
OE-CL-3P-32 3MTR CP
Finish : CP

Features:

- Die cast body
- Two point swing arm lock at top and bottom, also locking with the third point at central eliminates use of tower bolt
- System 32 compatible
- Reversible keys with click action mechanism
- High security computerized keys with plastic key head
- Available in 3 Point Lock

Application:

- Cupboards & Cabinets

CUPBOARD LOCKS



OE-CL-C 22MM CP
Cupboard Lock

Features:

- Suitable for 22mm Thick panel
- Die cast body
- Click action mechanism
- Round multipurpose lock with crank bolt specially designed for overlapped shutters fitted with auto close hinge and drawers with overlay facia
- Reversible keys with click action mechanism

Application:

- Cupboards & Cabinets

MULTI-PURPOSE LOCKS



- Features:**
- Suitable for 22mm Thick panel
 - Die cast body
 - Reversible keys with click action mechanism

- Application:**
- Cupboards & Cabinets

OE-MPL-R 22MM CP
Multipurpose Lock

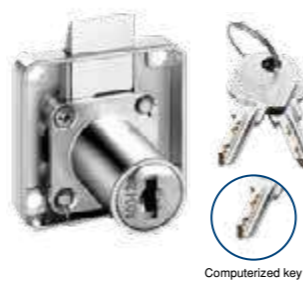

- Features:**
- Suitable for 22mm Thick panel
 - Die cast body
 - No key require for locking system
 - Reversible keys with click action mechanism
 - High security computerized keys

- Application:**
- Cupboards & Cabinets

OE-MPL-12 22MM CP
Multipurpose Lock with
Computerized Key



OE-MPL-11 22MM NP
Multipurpose Lock with
Computerized Key



OE-MPL 22MM CP
Multipurpose Lock



OE-MPL 32MM CP
Multipurpose Lock



OE-CL-33 STD SSS
Universal Lock

MULTIDRAWER LOCKS



OE-MDL 500MM CP
OE-MDL-4P 580MM CP

Front Mounted Multi Drawer Lock
with Aluminium Bar Length
500/580mm for 3/4 Drawers
No. of keys : 2 Keys



OE-MDL-3P-SM 500MM CP
OE-MDL-4P-SM 580MM CP

Side Mounted Multi Drawer Lock
with Aluminium Bar Length
500/580mm for 3/4 Drawers



OE-PDL-STD CP
For front mount multi
drawer pedestal units

DUAL LEG ELECTRIC TABLE



OZ-SMT-2L STD BLACK

Two Motor Three Stage with 4-Memory Function

- Features:**
- Single Leg Adjustable Table Frame
 - Dual Motor
 - Anti-collision sensors and safety control
 - Height Adjustment: 610-1260mm
 - Width Adjustment: 1050mm-1800mm
 - Speed: 32mm/s
 - Maximum Load: 120Kg
 - Stroke Length: 650 mm
 - Finish: White & Black
 - Wooden Table Top (Not Included)
 - Noise: <50db
 - Adjustment control button for up/down movement

SINGLE LEG ELECTRIC TABLE



OZ-SMT-1L STD BLACK

Single leg Adjustable Frame

- Features:**
- Anti-collision sensors and safety control
 - Height Adjustment: 610-1260mm
 - Width Adjustment: 480mm-750mm
 - Speed: 32mm/s
 - Maximum Load: 80Kg
 - Stroke Length: 650 mm
 - Finish: White & Black
 - Wooden Table Top (Not Included)
 - Noise: <50db
 - Adjustment control button for up/down movement

VERTEBRAE (CABLE ORGANIZER)



OZ-VRB 1.3MTR BLACK

Cable Organizer

- Features:**
- Suitable for work stations or desks
 - Conceals electric and data cables separately
 - Enhances the aesthetics of the work space

PLAIN BASKET



- Plain basket for use with ball bearing drawer runner
- Basket equipped with prefixed ball bearing runner clamps
- Order ball bearing runner separately
- Basket finish: Chrome

Order no. (500mm)	Basket size(WxDxH)	Order no. (550mm)	Basket size(WxDxH)
OZS-WB-P 15x20x4 CP	378x500x100 mm	OZS-WB-P 15x22x4 CP	378x550x100 mm
OZS-WB-P 15x20x6 CP	378x500x150 mm	OZS-WB-P 15x22x6 CP	378x550x150 mm
OZS-WB-P 15x20x8 CP	378x500x200 mm	OZS-WB-P 15x22x8 CP	378x550x200 mm
OZS-WB-P 17x20x4 CP	429x500x100 mm	OZS-WB-P 17x22x4 CP	429x550x100 mm
OZS-WB-P 17x20x6 CP	429x500x150 mm	OZS-WB-P 17x22x6 CP	429x550x150 mm
OZS-WB-P 17x20x8 CP	429x500x200 mm	OZS-WB-P 17x22x8 CP	429x550x200 mm
OZS-WB-P 19x20x4 CP	479x500x100 mm	OZS-WB-P 19x22x4 CP	479x550x100 mm
OZS-WB-P 19x20x6 CP	479x500x150 mm	OZS-WB-P 19x22x6 CP	479x550x150 mm
OZS-WB-P 19x20x8 CP	479x500x200 mm	OZS-WB-P 19x22x8 CP	479x550x200 mm
OZS-WB-P 21x20x4 CP	530x500x100 mm	OZS-WB-P 21x22x4 CP	530x550x100 mm
OZS-WB-P 21x20x6 CP	530x500x150 mm	OZS-WB-P 21x22x6 CP	530x550x150 mm
OZS-WB-P 21x20x8 CP	530x500x200 mm	OZS-WB-P 21x22x8 CP	530x550x200 mm

BASKET INSERTS



- Basket Inserts for conveniently storing kitchen essentials
- Equipped with connector for fixing with basket
- Insert length: 500/550 mm
- Finish: Chrome

Description	Product Image	Order no. (500mm)	Order no. (550mm)
Cup & Saucer Insert for basket height 150mm		OZS-WB-CS-HP 20x3 CP	OZS-WB-CS-HP 22x3 CP
Plate Insert for basket height 200mm		OZS-WB-PL-HP 20x5 CP	OZS-WB-PL-HP 22x5 CP
Thali Insert for basket height 200mm		OZS-WB-TH-HP 20x7 CP	OZS-WB-TH-HP 22x7 CP
Half Partition Insert for basket height 100mm		OZS-WB-P-HP 20x4 CP	OZS-WB-P-HP 22x4 CP
Half Partition Insert for basket height 150mm		OZS-WB-P-HP 20x6 CP	OZS-WB-P-HP 22x6 CP
Half Partition Insert for basket height 200mm		OZS-WB-P-HP 20x8 CP	OZS-WB-P-HP 22x8 CP

PERFORATED CUTLERY BASKET

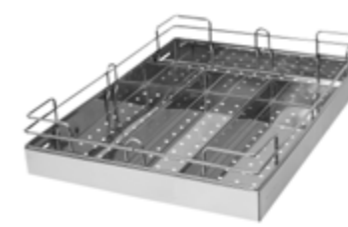

- Special Perforated metal sheet cutlery wire basket for use with ball bearing drawer runners
- Basket equipped with prefixed ball bearing runner clamps
- Order ball bearing runner separately
- Basket finish: Chrome

Order no. (500mm)	Basket size(WxDxH)	Order no. (550mm)	Basket size(WxDxH)
OZS-WB-C 15x20x4 CP	378x500x100 mm	OZS-WB-C 15x22x4 CP	378x550x100 mm
OZS-WB-C 17x20x4 CP	429x500x100 mm	OZS-WB-C 17x22x4 CP	429x550x100 mm
OZS-WB-C 19x20x4 CP	479x500x100 mm	OZS-WB-C 19x22x4 CP	479x550x100 mm
OZS-WB-C 21x20x4 CP	530x500x100 mm	OZS-WB-C 21x22x4 CP	530x550x100 mm

CUP & SAUCER BASKET

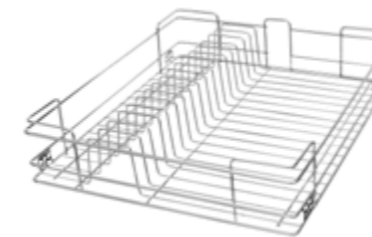

- Basket with prefixed saucer insert for use with ball bearing drawer runners
- Basket equipped with prefixed ball bearing runner clamps
- Order ball bearing runner separately
- Basket finish: Chrome

Order no. (500mm)	Basket size(WxDxH)	Order no. (550mm)	Basket size(WxDxH)
OZS-WB-CS 15x20x4 CP	378x500x100 mm	OZS-WB-CS 15x22x4 CP	378x550x100 mm
OZS-WB-CS 17x20x4 CP	429x500x100 mm	OZS-WB-CS 17x22x4 CP	429x550x100 mm
OZS-WB-CS 19x20x4 CP	479x500x100 mm	OZS-WB-CS 19x22x4 CP	479x550x100 mm
OZS-WB-CS 21x20x4 CP	530x500x100 mm	OZS-WB-CS 21x22x4 CP	530x550x100 mm

PLATE BASKET

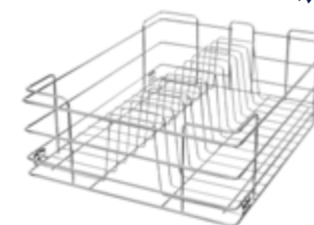

- Basket with prefixed plate insert for use with ball bearing drawer runners
- Basket equipped with prefixed ball bearing runner clamps
- Order ball bearing runner separately
- Basket finish: Chrome

Order no. (500mm)	Basket size(WxDxH)	Order no. (550mm)	Basket size(WxDxH)
OZS-WB-PL 15x20x6 CP	378x500x150 mm	OZS-WB-PL 15x22x6 CP	378x550x150 mm
OZS-WB-PL 17x20x6 CP	429x500x150 mm	OZS-WB-PL 17x22x6 CP	429x550x150 mm
OZS-WB-PL 19x20x6 CP	479x500x150 mm	OZS-WB-PL 19x22x6 CP	479x550x150 mm
OZS-WB-PL 21x20x6 CP	530x500x150 mm	OZS-WB-PL 21x22x6 CP	530x550x150 mm

THALI BASKET New

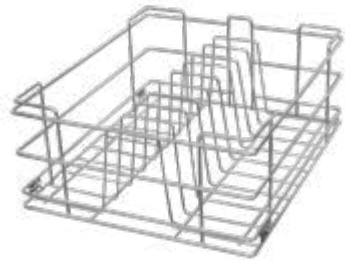

- Basket with prefixed thali insert for use with ball bearing drawer runners
- Basket equipped with prefixed ball bearing runner clamps
- Order ball bearing runner separately
- Basket finish: Chrome

Order no. (500mm)	Basket size(WxDxH)	Order no. (550mm)	Basket size(WxDxH)
OZS-WB-TH 15x20x8 CP	378x500x200 mm	OZS-WB-TH 15x22x8 CP	378x550x200 mm
OZS-WB-TH 17x20x8 CP	429x500x200 mm	OZS-WB-TH 17x22x8 CP	429x550x200 mm
OZS-WB-TH 19x20x8 CP	479x500x200 mm	OZS-WB-TH 19x22x8 CP	479x550x200 mm
OZS-WB-TH 21x20x8 CP	530x500x200 mm	OZS-WB-TH 21x22x8 CP	530x550x200 mm

GRAIN TROLLEY BASKET New



- Basket for storage of heavy items & use with ball bearing drawer runners
- Basket also equipped with prefixed ball bearing runner clamps
- Order pull out mechanism separately
- Basket finish: Chrome

Order no. (500mm)	Basket size(WxDxH)
OZS-WB-G 15x20x8 CP	378x500x200 mm
OZS-WB-G 17x20x8 CP	429x500x200 mm
OZS-WB-G 19x20x8 CP	479x500x200 mm
OZS-WB-G 21x20x8 CP	530x500x200 mm
OZS-WB-GMECH 21' GR	Grain trolley pull out mechanism

VEGETABLE BASKET New



- Basket for open storage of vegetables and fruits & use with ball bearing drawer runners
- Basket equipped with prefixed ball bearing runner clamps
- Order ball bearing runner (500 mm) separately
- Basket finish: Chrome

Order no. (500mm)	Basket size(WxDxH)
OZS-WB-V 15x20x6 CP	378x500x150 mm
OZS-WB-V 17x20x6 CP	429x500x150 mm

DETERGENT RACK New



- Wire based double decker rack for keeping detergents and cleaning agents
- For fixing onto hinged cabinet shutter
- Min cabinet width: 300 mm
- Basket Finish: Chrome

Order no.	Basket size(WxDxH)
OZS-W-D 150x450 SSS	253x155x383 mm

BOTTLE PULLOUT New

- Wire basket based narrow pull out units for conveniently storing bottles and small boxes
- Basket equipped with prefixed ball bearing runner clamps
- Order ball bearing runner(500mm) separately
- Basket finish: Chrome

Image	Order no. (500mm)	Basket size(WxDxH)
	OZS-W-BPO-2S 100x500 SSS	98x500x450 mm
	OZS-W-BPO-2S 150x500 SSS	150x500x450 mm
	OZS-W-BPO-3S 200x500 SSS	200x500x525 mm
	OZS-W-BPO-3S 250x500 SSS	250x500x525 mm

DISH RACK New



- Wire based dish rack to be used in overhead cabinets for keeping wet utensils
- Come in set for plate, thali tray & multi purpose tray
- Supplied with connectors for cabinet side wall
- Finish: Chrome

Order no.	Basket size(WxD)
OZS-W-DR 600MM SSS	600x250 mm
OZS-W-DR 800MM SSS	800x250 mm
OZS-W-DR 900MM SSS	900x250 mm

BIN HOLDER New



- Wire based waste bin holder for discarding kitchen waste
- Basket equipped with prefixed clamps for installation on cabinet hinged shutter
- Finish: Chrome

Order no.	Basket size(dia x H)
OZS-W-BH STD SSS	275x205 mm

CYLINDER TROLLEY New

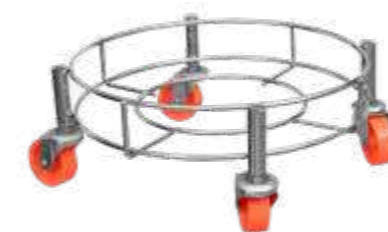

- Wire based wheeled trolley for keeping cooking gas cylinders
- Basket equipped with wheels for easy maneuver
- Finish: Chrome







Order no.	Basket size(dia x H)
OZS-W-CT STD SSS	315x125 mm



MORPHY SERIES





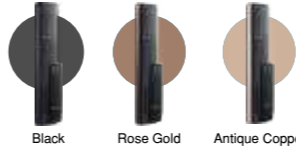



MORPHY NXT PLUS
OZ-FDL-01 LIFE NXT PLUS

For External Doors
Application: Wooden Doors | Metal Doors
Dimension: HxWxD - 395x75x40MM









MORPHY NXT
OZ-FDL-01 LIFE NXT

For External Doors
Application: Wooden Doors | Metal Doors
Dimension: HxWxD - 370x75x30MM









MORPHY LIFE LITE
OZ-FDL-01 LITE*
OZ-FDL-01 LIFE LITE

For External Doors
Application: Wooden Doors | Metal Doors
Dimension: HxWxD - 260x62x25MM







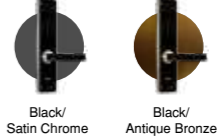

MORPHY BT PLUS
OZ-FDL-01 STD*
OZ-FDL-01 LIFE STD

For External Doors
Application: Wooden Doors | Metal Doors
Dimension: HxWxD - 335x70x20MM







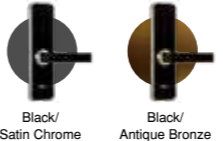

MORPHY M
OZ-FDL-02 STD*
OZ-FDL-02 LIFE STD

For External Doors
Application: Wooden Doors | Metal Doors
Dimension: HxWxD - 270x70x20MM

MORPHY ECO
OZ-FDL-04 STD*
OZ-FDL-04 LIFE BL

For External Doors
Application: Wooden Doors | Metal Doors
Dimension: HxWxD - 280x66x20MM

FINGERPRINT LOCKS
FOR DOOR & FURNITURE

ORACLE SERIES

ORACLE
OZ-FDL-11-R-LIFE

For Internal Doors
Application: Wooden Doors
Dimension: DepthxDia - 66x57MM



Black Bronze Gold

ORACLE
OZ-FDL-11-R-LIFE

For Internal Doors
Application: Wooden Doors
Dimension: DepthxDia - 66x57MM



Black Bronze Gold

ORACLE
OZ-FDL-11-LIFE

For Internal Doors
Application: Wooden Doors
Dimension: DepthxDia - 66x57MM



Black Bronze Gold

ORACLE
OZ-FDL-11-P-LIFE

For Internal Doors
Application: Wooden Doors
Dimension: DepthxDia - 66x57MM



Gold

CLEO SMART LOCK

CLEO SMART LOCK
OZ-DRL-STD*
OZ-DRL-LIFE STD

For Internal Doors
Application: Wooden Doors | Metal Doors
Dimension: HxWxD - 156x58x33MM



Black/ Satin Chrome Black/ Antique Bronze



NARROW STYLE

NARROW STYLE
OZ-FDL-33 LIFE SL STD
OZ-FDL-33 LIFE SW STD

For Internal Doors
Application: Wooden Doors | Metal Doors
Dimension: HxWxD - 307X36X25



Black



NARROW STYLE
OZ-FDL-33 STD*
OZ-FDL-33-60W SS

For External Doors
Application: Framed Aluminium Doors
Wooden Doors
Dimension: HxWxD - 280x38x25MM

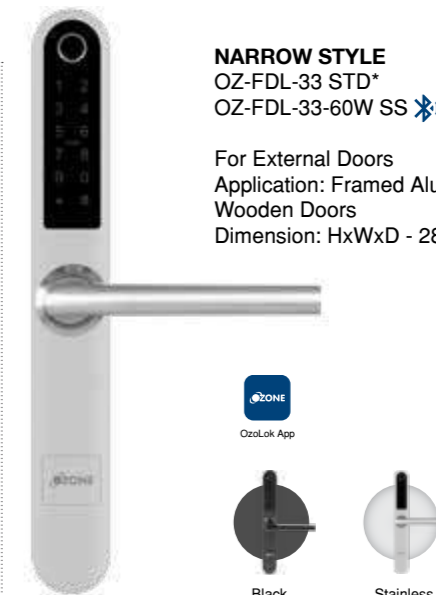

Black

Stainless Steel



UNIQ SMART DOOR LOCK

UNIQ SMART DOOR LOCK
OZ-FDL-05 LIFE STD

For External Doors
Application: Wooden Doors | Metal Doors
Dimension: HxWxD - 258x60x18MM



Black



TRINITY

TRINITY
OZ-FDL-22-RBL STD

For Internal Doors
Application: Wooden Doors
Dimension: Handle size (148x27MM Base 58MM)

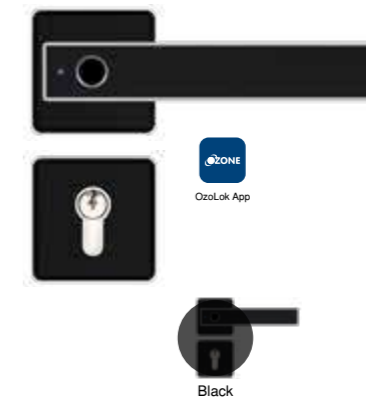

Black



GLASS DOOR LOCK



GLASS DOOR LOCK
OZ-FGL-LIFE-G2G BLACK

For Internal Doors
Application: Glass-to-Glass | Glass-to-Wall
Dimension: HxWxD - 170X65X40MM



GLASS DOOR LOCK
OZ-FGL-LIFE-G2W BLACK

For Internal Doors
Application: Glass-to-Glass | Glass-to-Wall
Dimension: HxWxD - 170X65X40MM



APP CONNECTED GLASS DOOR LOCK



GLASS DOOR LOCK
OZ-FGL-BL-G2G

For Internal Doors
Application: Glass-to-Glass | Glass-to-Wall
Dimension: HxWxD - 170x70x60MM



GLASS DOOR LOCK
OZ-FGL-BL-G2W

For Internal Doors
Application: Glass-to-Glass | Glass-to-Wall
Dimension: HxWxD - 170x70x60MM



ACCESSORIES

RFID LOCK
OZEL-RF222/333-Card V10 White



GLASS DOOR LOCK REMOTE
OZDL-23 RC-GL ACC



GATEWAY
OZ-GATEWAY-11
FOR OZOLOK PRODUCTS

OZ-LIFE-WB-11
FOR OZOLIFE PRODUCTS



PADLOCK SERIES





PADLOCK
OZ-DPL-22 BL Black
Dimension: HxWxD - 420x116x70MM



-  User Password
-  Mobile App
-  RFID Card
-  Emergency Key

PADLOCK
OZ-FPL-11-Black
Dimension: HxWxD - 142x114x25MM



-  Fingerprint
-  Emergency Key

PASSWORD, FINGERPRINT, RFID & KEY LOCK

OZFL-301V-PK
Password & Key Lock

For Wooden / Metal Cabinets & Wardrobes
Door Thickness: 1-18mm
Dimension: HxWxD - 96x42x26MM



-  Master Password
-  User Password
-  Emergency Key

OZFL-301H-PK
Password & Key Lock

For Metal Cabinets & Wardrobes
Door Thickness: 1-18mm
Dimension: HxWxD - 96x42x26MM



-  Master Password
-  User Password
-  Emergency Key

OZFL-302-FK
Fingerprint & Key Lock

For Wooden / Metal Cabinets & Wardrobes
Door Thickness: 1-18mm
Dimension: HxWxD - 96x42x26.3MM



-  Fingerprint
-  Emergency Key

OZFL-203-PF
Fingerprint & Password
For Wooden / Metal Cabinets & Wardrobes
Door Thickness: 1-25mm
Dimension: HxWxD - 107x56x12.5MM





-  Master Password
-  User Password
-  Fingerprint

OZFL-201-PW*
OZFL-201-LIFE PW
Password Lock

For Wooden / Metal Cabinets & Wardrobes
Door Thickness: 1-25mm
Dimension: HxWxD - 107x56x12.5MM



-  Guest Password
-  Master Password
-  User Password

OZFL-202-RF
RFID Card Lock

For Wooden / Metal Cabinets & Wardrobes
Door Thickness: 1-25mm
Dimension: HxWxD - 107x56x12.5MM



-  RFID Card

PASSWORD, FINGERPRINT, RFID & KEY LOCK

OZFL-101-PK
Password & Key Lock

For Wooden / Metal Cabinets & Wardrobes
Door Thickness: 1-18mm
Dimension: HxWxD - 125x55x17.2MM



OZFL-102-FPK
Fingerprint, Password & Key Lock

For Wooden / Metal Cabinets & Wardrobes
Door Thickness: 1-18mm
Dimension: HxWxD - 125x55x17.2MM

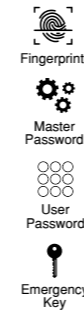

PASSWORD, FINGERPRINT, RFID & KEY LOCK

OZFL-55F Antique Bronze
Fingerprint Lock

For Wooden Cabinets, Wardrobes & Drawers
Door Thickness: 12-25mm
Depth: 24MM
Dia: 48MM



OZFL-55F SN
Fingerprint Lock

For Wooden Cabinets, Wardrobes & Drawers
Door Thickness: 12-25mm
Depth: 24MM
Dia: 48MM



OZFL-55F Black
Fingerprint Lock

For Wooden Cabinets, Wardrobes & Drawers
Door Thickness: 12-25mm
Depth: 24MM
Dia: 48MM



OZFL-401-PW
Password Lock

for Single or Multiple Metal / Wooden Drawers
for Swing & Sliding Metal & Wooden Cabinets & Wardrobes
Door Thickness: 1-25mm
Dimension: HxWxD - 57.5x57.5x20MM

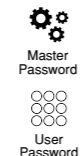
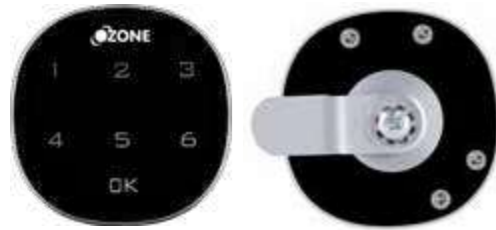

OZFL-402-F
Fingerprint Lock

for Single or Multiple Metal / Wooden Drawers
for Swing & Sliding Metal & Wooden Cabinets & Wardrobes
Door Thickness: 1-25mm
Dimension: HxWxD - 57.5x57.5x20MM



OZFL-404-PR
Password & RFID Card Lock

For Metal & Wooden Cabinets, Wardrobes & Drawers
Door Thickness: 1-25mm
Dimension: HxWxD - 65x65x13.6MM



OZFL-404-FP
Fingerprint Lock

for Metal & Wooden Cabinets, Wardrobes & Drawers
Door Thickness: 1-25mm
Dimension: Dia - 38MM



OZFL-403-RF
RFID Card Lock

for Single or Multiple Metal / Wooden Drawers
for Swing & Sliding Metal & Wooden, Cabinets & Wardrobes
Door Thickness: 1-25mm
Dimension: HxWxD - 57.5x57.5x20MM



OZFL-88P BLACK
Password Lock

For Wooden Cabinets, Wardrobes & Drawers
Door Thickness: 12-25mm
Dimension: WxDxDia - 22x12.5x50MM



OZFL-502 PW
Password Lock

For Metal Cabinets & Wardrobes
Door Thickness: 1-5mm
Dimension: HxWxD - 90x180x28MM



OZFL-501 PF
Password & Fingerprint Lock

For Metal Cabinets & Wardrobes
Door Thickness: 1-5mm
Dimension: HxWxD - 90x180x28MM





WIFI VIDEO DOORBELL

Smart Features



Wire-Free Installation

6700 mAh

Rechargeable Battery



PIR Motion Sensor
Instant & Accurate Alerts



Two-way
Communication



SD Card
128 GB



Wireless
Chime



Google Nest/
Alexa Echo Show



IP 65 Weather
Proof



Android/iOS System
Mobile Devices



Do It Yourself
Installation



2.4 MM Lens



16-24V AC
Wired Connection
(Optional)



Wi-Fi Frequency
2.4Ghz Only



OZ-LIFE-WDB-01

WORKS WITH ALEXA/GOOGLE ASSISTANT



= "Alexa/Google, show the front door."

Amazon Echo Show/
Google Nest



SECUREASY
ULTIMATE SECURITY. UNMATCHED EASE.

DETECTS MOTION DELIVER SAFETY

Featuring person-to-person motion detection and remote access, it swiftly notifies whenever a motion/person is detected via mobile app. Two-way communication allows for clear & loud conversations, and the infra-red night vision enables you to keep an alert eye during nighttime.

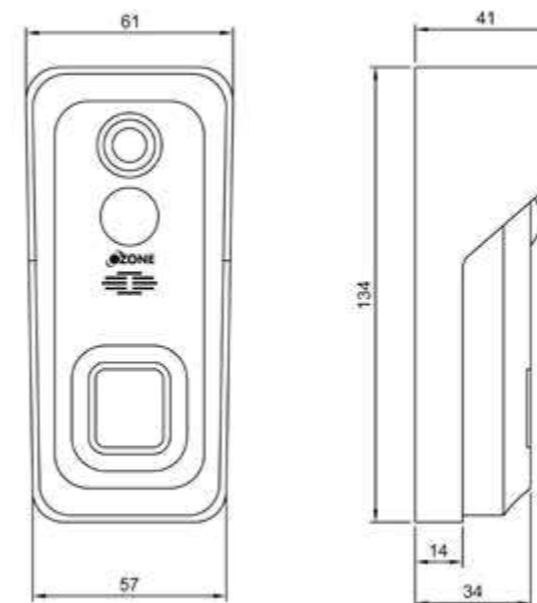

MULTI APARTMENT VIDEO DOOR PHONE



SINGLE APARTMENT VIDEO DOOR PHONE



Indoor Station

Smart Features

- 7" High Resolution Screen
- Feather Touch Button
- 2 Way Talk
- Custom Ringtones
- Snapshot Video
- Open 3 Locks
- 2 Doorbells + 2 Cameras
- Photo Frame
- SD Card 128 GB
- Remote Unlock
- Cascade upto 6 indoor monitors
- Wi-Fi Frequency 2.4Ghz Only

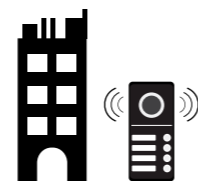

Outdoor Station

Smart Features

- 1080P
- IP 65 Weather Proof
- 2 Way Talk
- Day/Night Vision
- Motion Detection
- 2.8mm Lens
- Exit Button Function
- Connects upto 4 Floor
- RFID Card Unlock Function (Optional)



Wi-Fi



OzoLife App

APPLICATION: Multi Apartment

FINISH: ● Black

Indoor Station

Smart Features

- 7" High Resolution Screen
- Feather Touch Button
- 2 Way Talk
- Custom Ringtones
- Snapshot Video
- Photo Frame
- SD Card 128 GB
- Remote Unlock

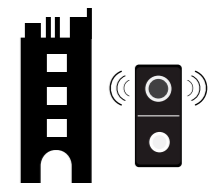

Outdoor Station

Smart Features

- 1080P
- IP 65 Weather Proof
- 2 Way Talk
- Day/Night Vision
- Motion Detection
- 2.8mm Lens
- RFID Card Unlock Function (Optional)



Wi-Fi



OzoLife App

APPLICATION: Single Apartment

FINISH: ● Black

PTZ INDOOR WI-FI CAMERA
OZ-LIFE-PC-01

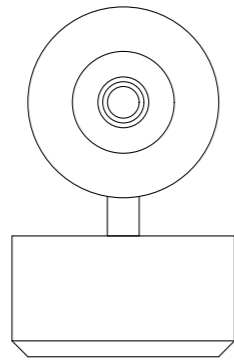
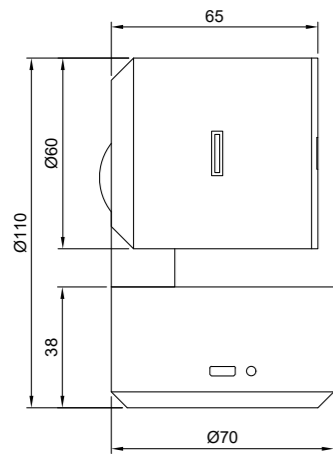

WORKS WITH ALEXA/GOOGLE ASSISTANT



Smart Features

- 360 View
- Cloud Storage (Optional)
- Motion Detection & Tracking
- Two-way Communication
- Ceiling/Wall Mounting
- Android/iOS System Mobile Devices
- Do It Yourself Installation
- Wi-Fi Frequency 2.4Ghz Only
- SD Card 128 GB
- FHD 1080P Camera
- 3.9 MM
- Infra-Red Night Vision
- Desktop Placement
- DC5V/1A
- Intelligent Scene Linkage

SMART INDOOR WI-FI CAMERA
OZ-LIFE-FC-01

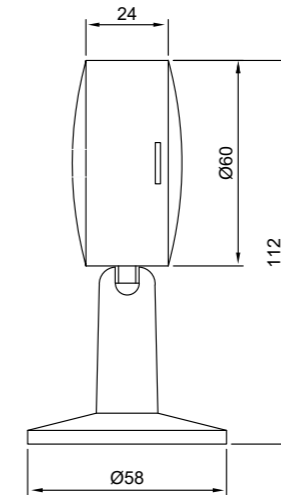
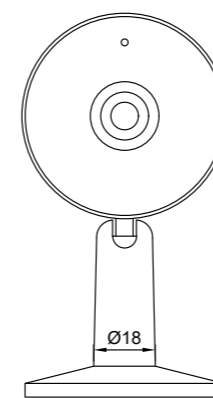

WORKS WITH ALEXA/GOOGLE ASSISTANT

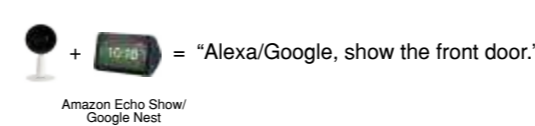

Smart Features

- Intelligent Scene Linkage
- Cloud Storage (Optional)
- Motion Detection
- Two-way Communication
- Ceiling/Wall Mounting
- Android/iOS System Mobile Devices
- Do It Yourself Installation
- SD Card 128 GB
- FHD 1080P Camera
- 3.6 MM
- Infra-Red Night Vision
- Desktop Placement
- DC5V/1A
- Wi-Fi Frequency 2.4Ghz Only

SMART PLUG
OZ-SP-10A LIFE



10A

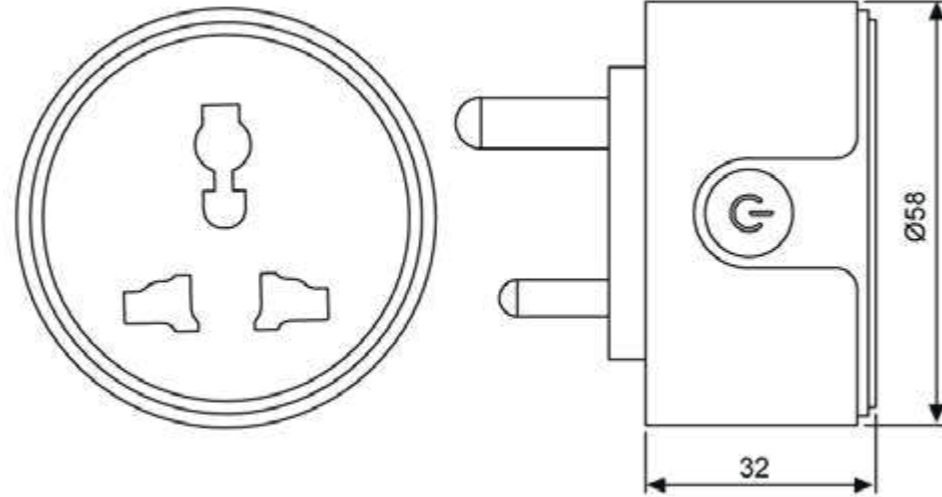

Specification

- Working Temp. -20°-50°C
- Wi-Fi Frequency 2.4Ghz Only
- Input Voltage AC 100V-240V

Smart Features

- Energy Monitoring
- Voice Control
- Set Schedules & Timer
- No Wiring Required
- Global Remote Access
- 24x7 Real Time Monitoring



SMART PLUG
OZ-SP-16A LIFE



16A

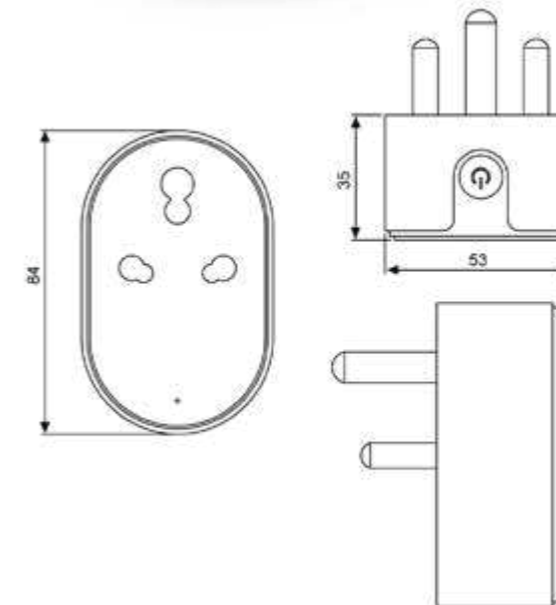

Specification

- Working Temp. -20°-50°C
- Wi-Fi Frequency 2.4Ghz Only
- Input Voltage AC 100V-240V

Smart Features

- Energy Monitoring
- Voice Control
- Set Schedules & Timer
- No Wiring Required
- Global Remote Access
- 24x7 Real Time Monitoring





DIGITAL SAFES
FOR HOMES, OFFICES, &
COMMERCIAL SPACES

FIRE WARRIOR SAFES



FIRE WARRIOR-22
Size(mm): (H)385X(W)496X(D) 390
Size(inch): (H)15.16X(W)19.49X(D)15.35
Weight: 46Kg approx
Open Records: 50
Volume (Ltr.): 19



FIRE WARRIOR-11
Size(mm): (H)385X(W)496X(D)390
Size(inch): (H)15.16X(W)19.53X(D)15.35
Weight: 47Kg approx
Open Records: 14
Volume (Ltr.): 19



FIRE WARRIOR-55
Size(mm): (H)595X(W)460X(D)470
Size(inch): (H)23.43X(W)18.11X(D)18.50
Weight: 80Kg approx
Open Records: 14
Volume (Ltr.): 40



FIRE WARRIOR-66
Size(mm): (H)595X(W)460X(D)470
Size(inch): (H)23.43X(W)18.11X(D)18.50
Weight: 74Kg approx
Open Records: 50
Volume (Ltr.): 39



FIRE WARRIOR-77
Size(mm): (H)760X(W)500X(D)490
Size(inch): (H)29.92X(W)19.69X(D)19.29
Weight: 110Kg approx
Open Records: 14
Volume (Ltr.): 67



FIRE WARRIOR-99
Size(mm): (H)985X(W)600X(D)570
Size(inch): (H)38.78X(W)23.62X(D)22.44
Weight: 185Kg approx
Open Records: 14
Volume (Ltr.): 145

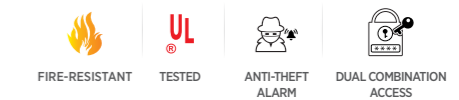

FIRE WARRIOR SAFES



FIRE WARRIOR-1200
Size(mm): (H)1200X(W)700X(D)635
Size(inch): (H)47X(W)27X(D)25
Weight: 270Kg approx
Volume (Ltr.): 230

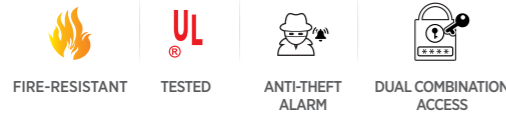

FIRE WARRIOR-1700
Size(mm): (H)1700X(W)800X(D)630
Size (inch): (H)66.93X(W)31.50X(D)24.80
Weight: 525Kg approx
Volume (Ltr.): 417

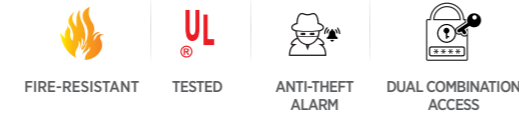

OES-FGP-FP-11
Size(mm): (H)370X(W)485X(D)430
Size(inch): (H)14.57X(W)19.09X(D)16.93
Weight: 52Kg approx
Volume (Ltr.): 19.50

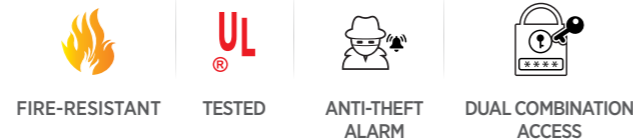

FIRE WARRIOR NOTIFY™ SAFES



FIRE WARRIOR-77 N SERIES
Size(mm): (H)760X(W)500X(D)490
Size(inch): (H)29.92X(W)19.69X(D)19.29
Weight: 110Kg approx
Volume (Ltr.): 67

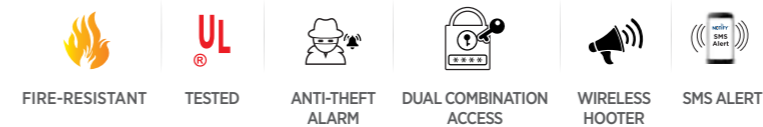

FIRE WARRIOR-99 N SERIES
Size(mm): (H)920X(W)600X(D)570
Size(inch): (H)36.22X(W)23.62X(D)22.44
Weight: 220Kg approx
Volume (Ltr.): 145

Features:

- Notify module inside the safe for extra safety
- Sms alert to upto 7 predefined mobile numbers
- Special fireproof material (cellulose concrete) ensures the inner temperature remains less than 118 c, while exposed in 1030 c flame for one hour
- User access: combination of user pin & manual key
- Emergency override key
- Strong steel shooting bolts
- Unique notify gsm module
- Vibration sensor to detect break-in/tempering
- Wireless hooter that can be placed away from the safe

***Get intrusion alerts on the registered mobile numbers.**

HOME & OFFICE SAFES



SAFILO BIO-X
Size(mm): (H)350X(W)400X(D) 350
Size(inch): (H)13.78X(W)15.74X(D)13.78
Weight: 21.30Kg approx
Volume (Ltr.): 40.80

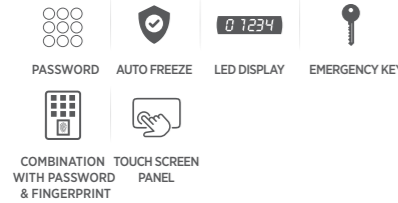

SAFILO BIO-1
Size(mm): (H)420X(W)350X(D)360
Size(inch): (H)16.54X(W)13.78X(D)14.17
Weight: 20Kg approx
Volume (Ltr.): 40

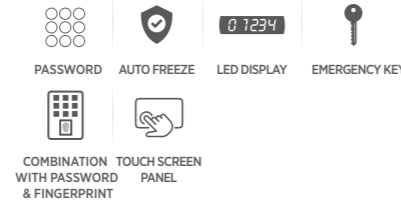

SAFILO BIO-2
Size(mm): (H)555X(W)350X(D)360
Size(inch): (H)21.85X(W)13.78X(D)14.17
Weight: 24.70Kg approx
Volume (Ltr.): 55

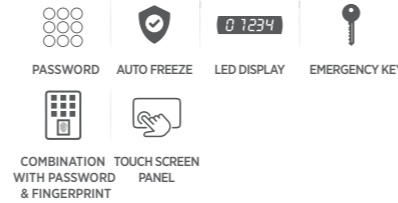

SAFILO DIGITAL-11
Size(mm): (H)250X(W)350X(D)250
Size(inch): (H)9.84X(W)13.77X(D)9.84
Weight: 9.4Kg approx
Volume (Ltr.): 15.94

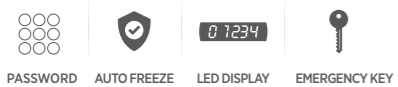

SAFILO DIGITAL-1
Size(mm): (H)420X(W)350X(D)360
Size(inch): (H)16.54X(W)13.78X(D)14.17
Weight: 20Kg approx
Volume (Ltr.): 40

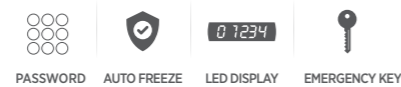

SAFILO DIGITAL-2
Size(mm): (H)555X(W)350X(D)360
Size(inch): (H)21.80X(W)13.77X(D)14.17
Weight: 24.70Kg approx
Volume (Ltr.): 55

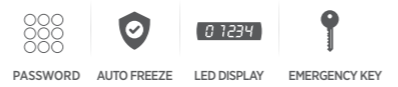

HOME & OFFICE SAFES



SAFILO BIO-Z
Size(mm): (H)250X(W)350X(D)250
Size(inch): (H)9.84X(W)13.77X(D)9.84
Weight: 9.5Kg approx
Volume (Ltr.): 16

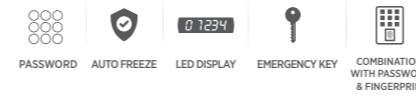

SAFILO BIO-Z PRO
Size(mm): (H)250X(W)455X(D)375
Size(inch): (H)9.84X(W)17.91X(D)14.76
Weight: 12.4Kg approx
Volume (Ltr.): 34.94

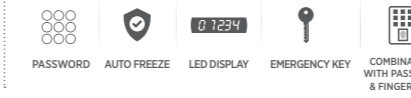

SAFILO BIO-MAX
Size(mm): (H)420X(W)350X(D)360
Size(inch): (H)16.53X(W)13.77X(D)14.17
Weight: 18.1Kg approx
Volume (Ltr.): 44.1

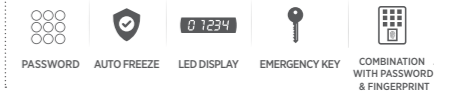

BAS-i10
Size(mm): (H)200X(W)300X(D)200
Size(inch): (H)7.87X(W)11.81X(D)7.87
Weight: 5.9Kg approx
Volume (Ltr.): 7.8



BAS-i20
Size(mm): (H)250X(W)350X(D)250
Size(inch): (H)9.84X(W)13.77X(D)9.84
Weight: 9Kg approx
Volume (Ltr.): 16.11



AGATE BLACK
Size(mm): (H)200X(W)350X(D)200
Size(inch): (H)7.8x(W)13.77x(D)7.8
Weight: 5.9Kg approx
Volume (Ltr.): 9.5



OES-17 EN GREY*
Size(mm): (H)170X(W)230X(D)170
Size(inch): (H)6.69X(W)9.06X(D)6.69
Weight: 4Kg approx
Volume (Ltr.): 4.50



Available on Projects Only*



OES-17 EN BLUE*
Size(mm): (H)170X(W)230X(D)170
Size(inch): (H)6.69X(W)9.06X(D)6.69
Weight: 4Kg approx
Volume (Ltr.): 4.50



Available on Projects Only*

HOME & OFFICE SAFES



TUSKER-10 GREY

Size(mm): (H)200X(W)350X(D)200
Size(inch): (H)7.87X(W)13.78X(D)7.87
Weight: 5.90Kg approx
Volume (Ltr.): 10

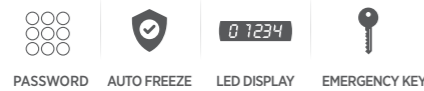

TUSKER-11 GREY

Size(mm): (H)250X(W)350X(D)250
Size(inch): (H)9.84X(W)13.78X(D)9.84
Weight: 9.50Kg approx
Volume (Ltr.): 16

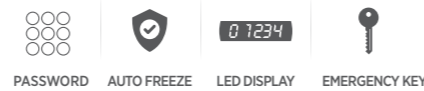

TUSKER-22 GREY

Size(mm): (H)200X(W)430X(D)380
Size(inch): (H)7.87X(W)16.92X(D)14.96
Weight: 11Kg approx
Volume (Ltr.): 30

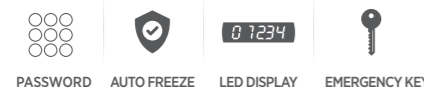

TUSKER-44 GREY

Size(mm): (H)350X(W)450X(D)355
Size(inch): (H)13.77X(W)17.71X(D)13.97
Weight: 21Kg approx
Volume (Ltr.): 44

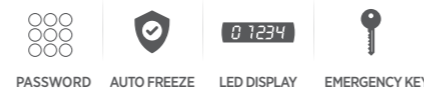

ECO-BB-77

Size(mm): (H)650X(W)440X(D)405
Size(inch): (H)25.59X(W)17.32X(D)15.94
Weight: 34.70Kg approx
Volume (Ltr.): 95.40



HOME & OFFICE SAFES



FORT AB-66

Size(mm): (H)555X(W)350X(D)360
Size(inch): (H)21.85X(W)13.77X(D)14.17
Weight: 64.34Kg approx
Volume (Ltr.): 78

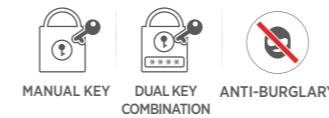

Features:

- Dual Key Combination Mechanical lock
- Strong steel body construction and powder-coated finish
- Five Heavy duty SS shooting Bolts
- Five spoke handle available to open and close the door
- Special feature:- Anti-burglary and tool resistance.



FORT AB-FP-66

Size(mm): (H)424X(W)460X(D)407
Size(inch): (H)16.69X(W)18.11X(D)16.02
Weight: 34.4Kg approx
Volume (Ltr.): 69



Features:

- Digital keypad with LED light option
- Dual Password (User + Master)
- User access: 4 to 8 digits password and 50 fingerprint
- Combination :- finger + password, finger +finger, password + password
- Low Battery indication
- Emergency key to open the safe in case you forget the user & master password
- Keypad auto freezes while entering wrong password three times
- Five spoke handle available to open and close the door
- Special feature:- Anti-burglary and tool resistance



FORT AB-DIGI-66

Size(mm): (H)424X(W)460X(D)407
Size(inch): (H)16.69X(W)18.11X(D)16.02
Weight: 34.4Kg approx
Volume (Ltr.): 69



Features:

- Digital keypad with LED light option
- Dual Password (User + Master)
- User access: 4 to 8 digits password
- Low Battery indication
- Emergency key to open the safe in case you forget the user & master password
- Keypad auto freezes while entering wrong password three times
- Five spoke handle available to open and close the door
- Special feature:- Anti-burglary and tool resistance

HOTEL SAFES



O-SQUIRE
Size(mm): (H)200X(W)350X(D)200
Size(inch): (H)7.87X(W)13.78X(D)7.87
Weight: 5.9Kg approx
Volume (Ltr.): 9

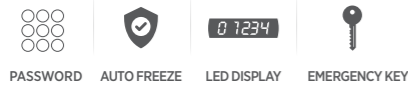

ARIES
Size(mm): (H)250X(W)350X(D)250
Size(inch): (H)9.84X(W)13.78X(D)9.84
Weight: 9.2Kg approx
Volume (Ltr.): 14.6

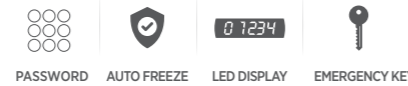

O-LAPTOP
Size(mm): (H)200X(W)430X(D)380
Size(inch): (H)7.87X(W)16.93X(D)14.96
Weight: 11Kg approx
Volume (Ltr.): 24.5

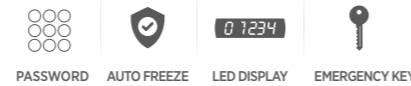

AGATE LAPTOP
Size(mm): (H)200X(W)430X(D)380
Size(inch): (H)7.87X(W)16.93X(D)14.96
Weight: 10.7Kg approx
Volume (Ltr.): 24.7



JADE BLACK-01
Size(mm): (H)200X(W)350X(D)200
Size(inch): (H)7.87X(W)13.78X(D)7.87
Weight: 6.4Kg approx
Volume (Ltr.): 9.8



JADE BLACK
Size(mm): (H)200(W)435X(D)365
Size(inch): (H)7.87X(W)17.13X(D)14.37
Weight: 12.45Kg approx
Volume (Ltr.): 26



**ACCESSORY
CONVENIO DIGITAL-33 ACC**
Hand Held Device for
CONVENIO-33 STD
(Activity record of last 100 opening)

MANUAL SAFES



CONVENIO MANUAL - 10
Size(mm): (H)199X(W)350X(D)199
Size(inch): (H)7.87X(W)13.77X(D)7.87
Weight: 5.9Kg approx
Volume (Ltr.): 10



Available on Projects Only*



CONVENIO MANUAL - 11
Size(mm): (H)250X(W)350X(D)250
Size(inch): (H)9.84X(W)13.78X(D)9.84
Weight: 9Kg approx
Volume (Ltr.): 15.50



Available on Projects Only*



CONVENIO MANUAL-11S
Size(mm): (H) 254X(W)350X(D)250
Size(inch): (H)10X(W)13.77X(D)9.84
Weight: 12.5Kg approx
Volume (Ltr.): 16



CONVENIO DIGITAL -33
Size(mm): (H)127X(W)400X(D)350
Size(inch): (H)5x(W)15.75x(D)13.77
Weight: 11.2Kg approx
Volume (Ltr.): 10



MANUAL SAFES



GUARDIAN MANUAL - 11
 Size(mm): (H)420X(W)350X(D)360
 Size(inch): (H)16.53X(W)13.77X(D)14.17
 Weight: 20Kg approx
 Volume (Ltr.): 40



- Features:**
- Dual combination key system
 - Innovative 3 side moulded body design with 5 mm door thickness
 - Two Heavy-Duty SS Shooting Stainless Bolts
 - Aesthetic Stainless Steel vault handle
 - 5 Spoke handle available
 - Superior 6 lever locking mechanism
 - Double compartment customization available



GUARDIAN MANUAL - 12
 Size(mm): (H)424X(W)460X(D)407
 Size(inch): (H)16.69X(W)18.11X(D)16
 Weight: 34.4Kg approx
 Volume (Ltr.): 69



- Features:**
- Dual combination key system
 - Innovative 3 side moulded body design with 5 mm door thickness
 - Two Heavy-Duty SS Shooting Stainless Bolts
 - Aesthetic Stainless Steel vault handle
 - 5 Spoke handle available
 - Superior 6 lever locking mechanism
 - Double compartment customization available

HAZARD SAFES



- Blue for corrosive liquids
- Red for Combustible liquids
- Yellow for flammable liquids

- Features:**
- Sturdy 1mm double-wall steel with 38mm of insulating air space
 - Self-latching doors
 - Fully welded and riveted construction
 - Continuous piano hinge provides smooth closure
 - Dual vents with built-in flash arresters placed at bottom & opposite top
 - Safety shelves designed to handle incidental spills to back & bottom of leak proof sump

OZ-ISC-SCD 410 LTR RED
 Size(mm): (H)1650X(W)1500X(D)860
 Weight: 270Kg approx

HxWxD (mm)	560x430x430	890x590x460	1650x590x460	1120x1090x460	1650x1090x460	1650x860x860	1650x1090x860	1650x1500x860
Capacity (Ltr)	15	45	83	114	170	227	340	410
Weight (Kg.)	35	56	85	100	138	165	190	270
Adjustable Shelves (Pcs)	1	1	2	1	2	2	2	2
Shelves capacity (Kg)	50	50	50	100	100	100	100	100
Door Type	Single Door	Single Door	Single Door	Double Door	Double Door	Double Door	Double Door	Double Door
Cabinet for Flammable liquids - item code	OZ-ISC-15 Ltr Yellow	OZ-ISC-45 Ltr Yellow	OZ-ISC-83 Ltr Yellow	OZ-ISC-114 Ltr Yellow	OZ-ISC-170 Ltr Yellow	OZ-ISC-227 Ltr Yellow	OZ-ISC-340 Ltr Yellow	OZ-ISC-410 Ltr Yellow
Cabinet for Combustible liquids - item code	OZ-ISC-15 Ltr Red	OZ-ISC-45 Ltr Red	OZ-ISC-83 Ltr Red	OZ-ISC-114 Ltr Red	OZ-ISC-170 Ltr Red	OZ-ISC-227 Ltr Red	OZ-ISC-340 Ltr Red	OZ-ISC-410 Ltr Red
Cabinet for Corrosive liquids - item code	OZ-ISC-15 Ltr Blue	OZ-ISC-45 Ltr Blue	OZ-ISC-83 Ltr Blue	OZ-ISC-114 Ltr Blue	OZ-ISC-170 Ltr Blue	OZ-ISC-227 Ltr Blue	OZ-ISC-340 Ltr Blue	OZ-ISC-410 Ltr Blue

S.No.	Product Image	Product code	Products
1.		OZ-FDL-02-WL DS	OZ-FDL-02 STD BLACK OZ-FDL-02 STD SC OZ-FDL-02 STD AB
2.		OZ-S-CLEO DS	OZ-DRL- LIFE STD BLACK OZ-DRL- LIFE STD SC OZ-DRL- LIFE STD AB
3.		OZ-FGL-Life G2G Black DS	OZ-FGL-LIFE-G2G BLACK OZ-FGL-LIFE-G2W BLACK

*T&C Apply

S.No.	Product Image	Product code	Products
4.		OZ-FDL-33 Life SL Std DS	OZ-FDL-33 LIFE SW STD OZ-FDL-33 LIFE SL STD
5.		OZ-FDL-03-BL DS	OZ-FDL-03 LIFE STD Black OZ-FDL-03 LIFE STD SC
6.		OZ-S-NXT DS	OZ-FDL-01 LIFE NXT BLACK OZ-FDL-01 LIFE NXT GREY OZ-FDL-01 LIFE NXT ROSE GOLD

*T&C Apply

S.No.	Product Image	Product code	Products
7.		OZ-FDL-01 WL DS	OZ-FDL-01 LIFE STD BLACK OZ-FDL-01 LIFE STD SC OZ-FDL-01 LIFE STD AB
8.		OZ-FDL-04-WL DS	OZ-FDL-04 STD BLACK

*T&C Apply

S.No.	Product Image	Product code	Products
9.		OZ-SC-Furniture Lock Standees-Round	OZFL-401-PW OZFL-88 P BLACK OZFL-55F BLACK OZFL-55F SN OZFL-55F ANTIQUE BRONZE
10.		OZ-SC-Furniture Lock Standees-Vertical	OZFL-203-PF OZFL-202-RF OZFL-102-FPK
11		OZ-FDL-11 WL-DS	OZ-FDL-11-R-LIFE BLACK OZ-FDL-11-R-LIFE BRONZE OZ-FDL-01 LIFE STD GOLD

*T&C Apply

International Offices



Melbourne, Australia

32-40 Tarnard Drive, Braeside VIC
3195, Tel: +61 1300 088 225
Mob +61 (0) 4 301 301 02
info@ozoneaustralia.com.au
www.ozoneaustralia.com.au



Dubai, UAE

OZONE MEA TRADING LLC
Office no 129, Al Uruba Business
center, garhoud views building,
mezzanine floor (M1-3) Al
Garhoud, PO Box 430704,
Dubai UAE.

Works

Ozone Overseas Pvt. Ltd.
Trilokpur Road, Kheri,
Nahan District-Sirmour
Kala Amb
Himachal Pradesh

For Hardware Solutions:

New Delhi*

1/122, Timber Mkt., Kirti Nagar,
New Delhi
Tel : +91-11-49124400, 01
delhihub@ozone-india.com

For Security Solutions:

Gurugram*

#548 Udyog Vihar, Phase 5,
Sector 19, Gurugram,
Haryana-122016
Tel: +91-124-4961164, 65

Branch Offices

Ahmedabad

407, 4th Floor, Shivalik Abaise,
Opp. Shell Petrol Pump,
Pralhadnagar,
Ahmedabad - 380051
Tel: +91-079-29706789

Bengaluru*

No. 424, 2nd Floor, Above
HDFC Bank,
Passport Office Road, 6th block,
Koramangala, Bangalore - 560034
Tel: +91-80-41207539
blrhub@ozone-india.com

Chandigarh

SCO 907, NAC Mani Majra
Near Solitaire Hotel,
Chandigarh - 160101
Mob: +91-9316001154

Chennai*

1-A, Jasoda Apartments,
No: 12, Ground Floor, Bank Street,
Kilpauk, Chennai - 600010.
Tel: 044-43802063

Cochin

No. 737/11, Opp. Lotus Club,
Warriam Road, Eranakulam, Cochin
Kerala - 682016
Mob: +91-7291981739

Hyderabad

Unit # 704, 7th Floor,
Shangrila Plaza,
Road No. 2, Banjara Hills,
Hyderabad - 500034

Indore

503, B Block,
Prakrati Corporate,
Y N Road, Indore - 452001
Mob: +91-9589589902

Jaipur

27, 5th Floor, Mahima Trinity Mall,
Swey Farm, New Sanganer Road,
Jaipur-302019
Tel: +91-141-2294261
jaipurhub@ozone-india.com

Kolkata

4 Govt Place, 4th floor,
Room No:- 4H
Delta House. Kolkatta - 700001
Mob: +91-9831176481

Lucknow*

Ground Floor,
Eldeco Corporate Chambers,
Vibhuti Khand, Gomti Nagar,
Lucknow - 226010
Tel: +91-0522-4109647
Mob: 9794970000

Mumbai

The Avenue, 607,
Near Waterstones Hotel,
Int. Airport Road,
Marol, Andheri (E),
Mumbai - 400059
Tel : +91-22-28306453
Mob: +91-7045775977

Pune

#105, 1st Floor, Suyog Center
Market Yard, Gultekdi,
Pune - 411037
Mob: +91-7678117567

Surat

201, Luxuria Business Hub,
Nr.V.R.Mall, Surat-Dumas Road,
New Magdalla Road,
Surat - 395007
Mob: +91-9724009921

Visakhapatnam

Door No 48-3-39, Sarayu Residency
Srinagar, Opp. Day and Night
Hospital, Visakhapatnam
A.P. 530016
Mob: +91-9515156438

*Also Operation Office

Download Ozone India App



Visit Website



Android



iOS

Specifications subject to change without notice



Corporate Office: H-40, Bali Nagar, New Delhi - 110015, INDIA

www.ozone-india.com | Customer Care: +91-9310012300 | customercare@ozone-india.com